

TO-252-2L Encapsulate Voltage Regulators

CJ7912 Three-terminal negative voltage regulator

FEATURES

- Maximum output current
 $I_{OM}: 1.5\text{ A}$
- Output voltage
 $V_O: -12\text{ V}$
- Continuous total dissipation
 $P_D: 1.25\text{ W}$ ($T_a = 25\text{ }^\circ\text{C}$)

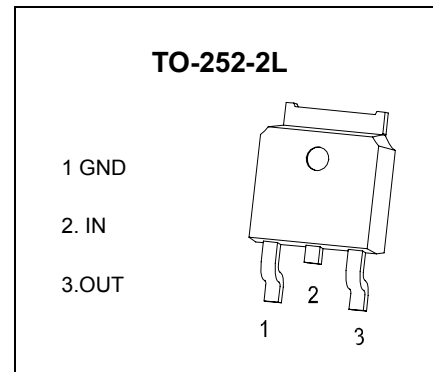

ABSOLUTE MAXIMUM RATINGS (Operating temperature range applies unless otherwise specified)

Parameter	Symbol	Value	Unit
Input Voltage	V_i	-30	V
Thermal Resistance from Junction to Air	$R_{\theta JA}$	100	$^\circ\text{C/W}$
Operating Junction Temperature Range	T_{OPR}	0~+150	$^\circ\text{C}$
Storage Temperature Range	T_{STG}	-65~+150	$^\circ\text{C}$

ELECTRICAL CHARACTERISTICS AT SPECIFIED VIRTUAL JUNCTION TEMPERATURE ($V_i = -19\text{ V}, I_o = 500\text{ mA}, C_i = 2.2\mu\text{F}, C_o = 1\mu\text{F}$, unless otherwise specified)

Parameter	Symbol	Test conditions	Min	Typ	Max	Unit
Output Voltage	V_o	25°C	-11.52	-12	-12.48	V
		$-14.5\text{ V} \leq V_i \leq -27\text{ V}, I_o = 5\text{ mA} - 1\text{ A}$	0-125 $^\circ\text{C}$	-11.4	-12	-12.6
Load Regulation	ΔV_o	$I_o = 5\text{ mA} - 1.5\text{ A}$	25°C	15	200	mV
		$I_o = 250\text{ mA} - 750\text{ mA}$	25°C	5	75	mV
Line Regulation	ΔV_o	$-14.5\text{ V} \leq V_i \leq -30\text{ V}$	25°C	5	80	mV
		$-16\text{ V} \leq V_i \leq -22\text{ V}$	25°C	3	30	mV
Quiescent Current	I_q	25°C		2	3	mA
Quiescent Current Change	ΔI_q	$-14.5\text{ V} \leq V_i \leq -30\text{ V}$	0-125 $^\circ\text{C}$		0.5	mA
		$5\text{ mA} \leq I_o \leq 1\text{ A}$	0-125 $^\circ\text{C}$		0.5	mA
Output Noise Voltage	V_N	$10\text{ Hz} \leq f \leq 100\text{ KHz}$	25°C	300		$\mu\text{V}/V_o$
Output Voltage Drift	$\Delta V_o / \Delta T$	$I_o = 5\text{ mA}$	0-125 $^\circ\text{C}$	-0.8		mV/ $^\circ\text{C}$
Ripple Rejection	RR	$-15\text{ V} \leq V_i \leq -25\text{ V}, f = 120\text{ Hz}$	0-125 $^\circ\text{C}$	54	60	dB
Dropout Voltage	V_d	$I_o = 1\text{ A}$	25°C	1.1		V
Peak Current	I_{pk}	25°C		2.1		A

* Pulse test.

TYPICAL APPLICATION

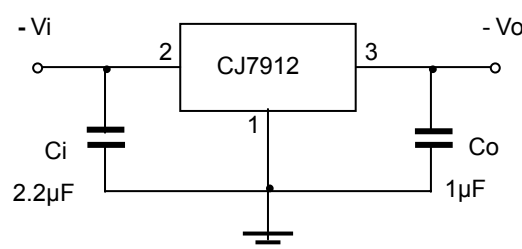

TO-252(4R)-2L Package Outline Dimensions

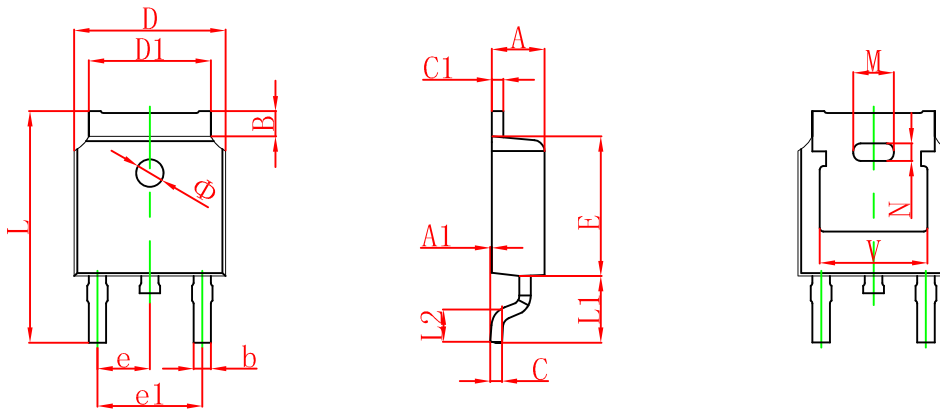

Symbol	Dimensions In Millimeters		Dimensions In Inches	
	Min.	Max.	Min.	Max.
A	2.200	2.380	0.087	0.094
A1	0.000	0.100	0.000	0.004
B	0.800	1.400	0.031	0.055
b	0.710	0.810	0.028	0.032
c	0.460	0.560	0.018	0.022
c1	0.460	0.560	0.018	0.022
D	6.500	6.700	0.256	0.264
D1	5.130	5.460	0.202	0.215
E	6.000	6.200	0.236	0.244
e	2.286 TYP.		0.090 TYP.	
e1	4.327	4.727	0.170	0.186
M	1.778REF.		0.070REF.	
N	0.762REF.		0.018REF.	
L	9.800	10.400	0.386	0.409
L1	2.9REF.		0.114REF.	
L2	1.400	1.700	0.055	0.067
V	4.830 REF.		0.190 REF.	
Φ	1.100	1.300	0.043	0.051

TO-252(4R)-2L Suggested Pad Layout

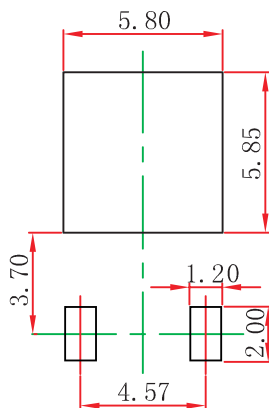

Note:

1. Controlling dimension: in millimeters.
2. General tolerance: ± 0.05 mm.
3. The pad layout is for reference purposes only.

NOTICE

JCET reserve the right to make modifications, enhancements, improvements, corrections or other changes without further notice to any product herein. JCET does not assume any liability arising out of the application or use of any product described herein.

To-252(4R)-2L Tape and Reel

TO-252 Embossed Carrier Tape

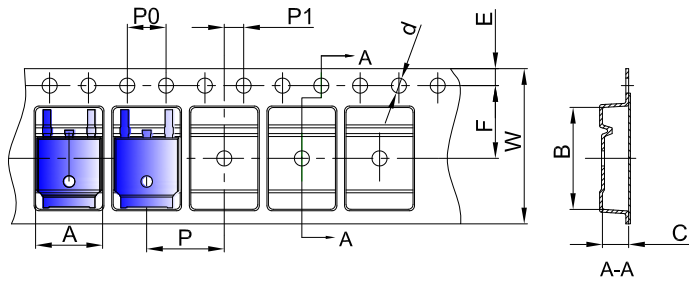

Packaging Description:

TO-252 parts are shipped in tape. The carrier tape is made from a dissipative (carbon filled) polycarbonate resin. The cover tape is a multilayer film (Heat Activated Adhesive in nature) primarily composed of polyester film, adhesive layer, sealant, and anti-static sprayed agent. These reeled parts in standard option are shipped with 25,00 units per 13" or 33.0 cm diameter reel. The reels are clear in color and is made of polystyrene plastic (anti-static coated).

Dimensions are in millimeter										
Pkg type	A	B	C	d	E	F	P0	P	P1	W
TO-252	6.90	10.50	2.70	Ø1.55	1.75	7.50	4.00	8.00	2.00	16.00

TO-252 Tape Leader and Trailer

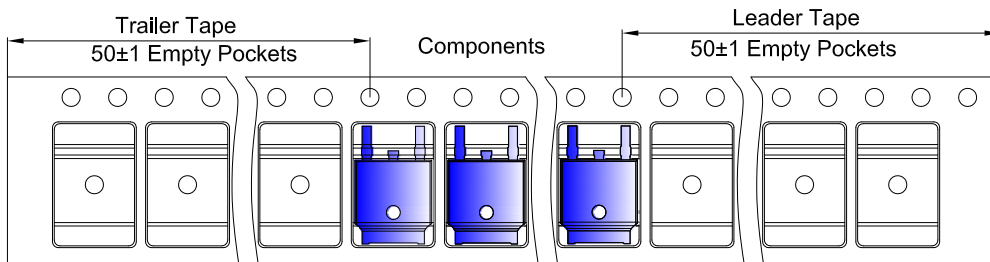

TO-252 Reel

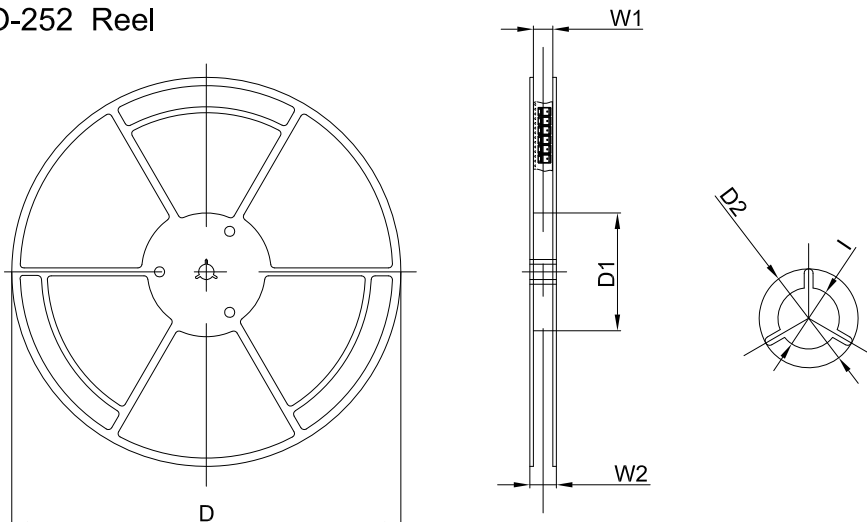

Dimensions are in millimeter						
Reel Option	D	D1	D2	W1	W2	I
13" Dia	330.00	100.00	Ø21.00	16.40	21.00	Ø13.00

REEL	Reel Size	Box	Box Size(mm)	Carton	Carton Size(mm)	G.W.(kg)
2,500 pcs	13inch	2,500 pcs	340×336×29	25,000 pcs	353×346×365	