

# 规格(承认)书

## Specification for approval

※ 方舟 P/N (ARKLED P/N): SP220361/SP210361

※ 客户 P/N (CUSTOMER P/N): \_\_\_\_\_

※ 产品说明 (DESCRIPTION):

1. 0.36 inch (9.2mm) Digit Height
2. Three Digits Numeric LED Display
3. Ultra Brightness Green

※ 日期 (DATE): 2012-5-22

地址: 江苏省宜兴市张渚镇金张渚工业区宇龙路6号

**FACTORY ADD: NO.6 Yulong Road, ZHANGZHU TOWN, YIXING CITY, JIANGSU PROVINCE, P.R.CHINA**

**Ningbo Branch:**

电话 (TEL): **0086-574-86308393**

E-mial: **ark@arkled.net**

传真 (FAX): **0086-574-86308392**

网址(http) : **www.arkled.net**

0.36 Inch Numeric LED Display

Part No: SP220361, SP210361



## FEATURES

- High intensity and reliability
- High quality, Low power requirement and low cost
- IC compatible, Easy assembly
- Meet RoHS EU Directive

## DESCRIPTION

- The device of this 0.36 inch numeric LED display is made of 4 elements (AlGaInP) material, designed for viewing distance up to 7 meters.
- It can be used in audio equipment, instruments, numeric read out display and so on.
- Standard appearance color is black or grey face and white segment.

## Selection Guide

Part No. CC <sup>[1]</sup>	Part No. CA <sup>[2]</sup>	Dice	Iv(mcd) <sup>[3]</sup> @20mA	
			Min.	Typ.
SP220361	SP210361	Ultra Bright Green (AlGaInP)	17	50

Note:

1. CC is Common Cathode.
2. CA is Common Anode.
3. Luminous intensity/ luminous Flux: +/-15%.

0.36 Inch Numeric LED Display

Part No: SP220361, SP210361



**ABSOLUTE MAXIMUM RATINGS AT Ta=25°C**

PARAMETER	SYMBOL	ULTRA-BRIGHT Green	UNIT
Power Dissipation Per Segment	PAD	100	mw
Reverse Voltage Per Segment	VR	5	V
Continuous Forward Current Per Segment	IAF	30	mA
Peak Forward Current Per Segment(Duty-0.1,1KHz)	IPF	200	mA
Operating Temperature Range	TOPr	-20°C to 80°C	
Storage Temperature Range	Tstg	-30°C to 85°C	
Lead Soldering Temperature 260°C at 1.6mm From Body for 3 second			

**ELECTRICAL/OPTICAL CHARACTERISTICS AT Ta=25°C**

PARAMETER	SYMBOL	TEST CONDITION	Color	TYP	MAX	UNIT
Forward Voltage ,Per Segment	VF	IF=20mA	ULTRA-BRIGHT Green	2.1	2.6	V
Reverse Current , Per Segment	IR	VR=5V	ULTRA-BRIGHT Green		50	µA
Peak Emission Wavelength	λp	IF=20mA	ULTRA-BRIGHT Green	565		nm

# 0.36 Inch Numeric LED Display

Part No: SP220361, SP210361



## Package Dimensions and Internal Circuit Diagram

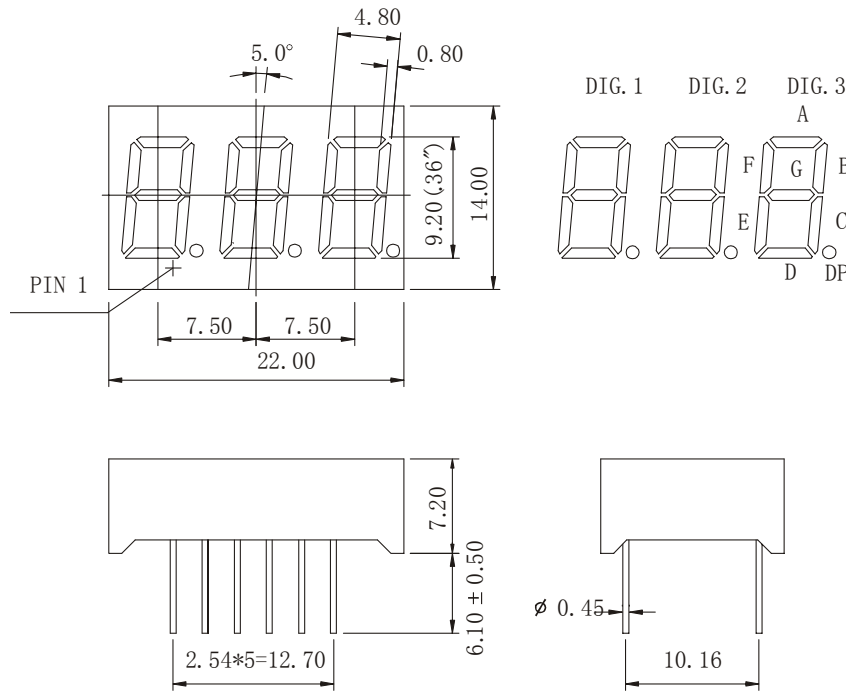

### SP20361

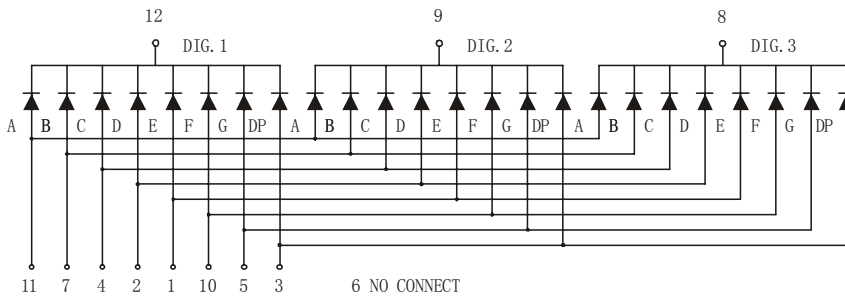

### SP10361

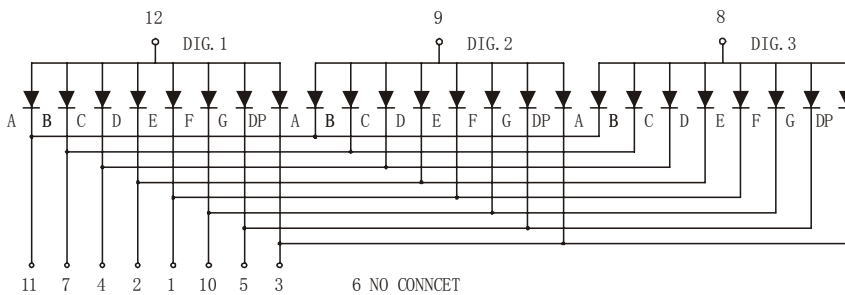

- NOTES: 1. all dimensions are in millimeters. (Inches)  
2. Tolerance is  $\pm 0.25(0.010)$  unless otherwise specified.



### Typical Electrical-Optical Characteristics Curves

Forward Current Vs Forward Voltage

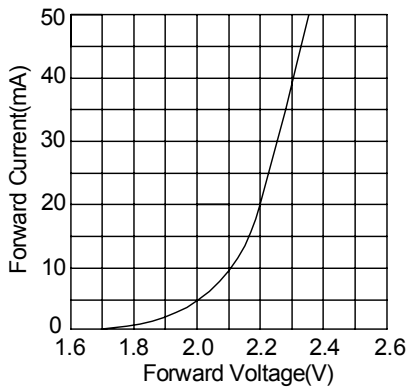

Relative Intensity Vs Forward Current

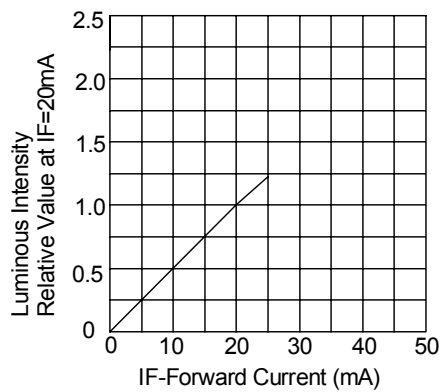

Forward Current Vs Environmental Temp

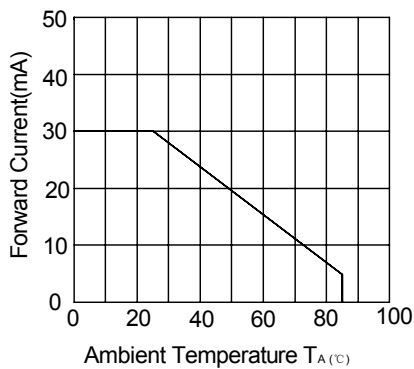

Relative Intensity Vs Environmental Temp

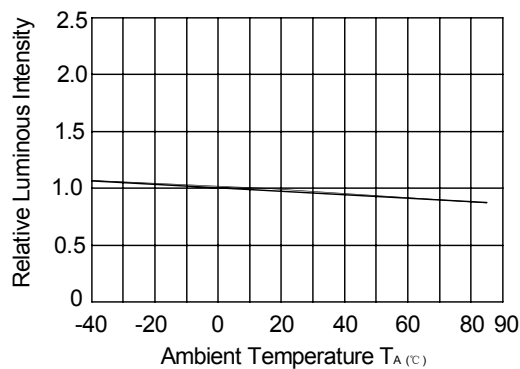

Relative Intensity Vs Wavelength

