

# YGW60N65T1

**650V /60A Trench Field Stop IGBT**

## FEATURES

- High breakdown voltage up to 650V for improved reliability
- Trench-Stop Technology offering :
  - High speed switching
  - High ruggedness, temperature stable
  - Low  $V_{CEsat}$
  - Easy parallel switching capability due to positive temperature coefficient in  $V_{CEsat}$
- Enhanced avalanche capability

$V_{CE}$	<b>650</b>	<b>V</b>
$I_C$	<b>60</b>	<b>A</b>
$V_{CE(sat)} I_C=60A$	<b>1.85</b>	<b>V</b>

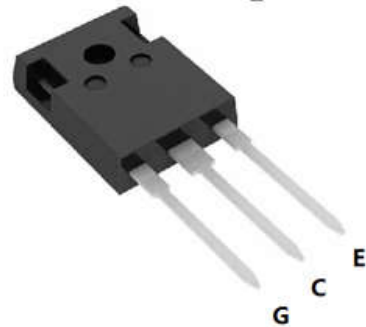
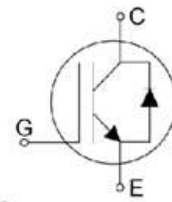

## APPLICATION

- Uninterruptible Power Supplies
- Inverter
- Welding Converters
- PFC applications
- Converter with high switching frequency

Product	Package	Packaging
YGW60N65T1	TO247	Tube

**Maximum Ratings** ( $T_j = 25^\circ\text{C}$  unless otherwise specified)

Parameter	Symbol	Value	Unit
Collector-Emitter Breakdown Voltage	$V_{CE}$	650	V
DC collector current, limited by $T_{jmax}$ $T_C = 25^\circ\text{C}$ $T_C = 100^\circ\text{C}$	$I_C$	120 60	A
Diode Forward current, limited by $T_{jmax}$ $T_C = 25^\circ\text{C}$ $T_C = 100^\circ\text{C}$	$I_F$	120 60	A
Continuous Gate-emitter voltage	$V_{GE}$	$\pm 20$	V
Transient Gate-emitter voltage	$V_{GE}$	$\pm 30$	V
Turn off safe operating area $V_{CE} \leq 650\text{V}$ , $T_j \leq 175^\circ\text{C}$	-	180	A
Pulse collector current, $V_{GE} = 15\text{V}$ , $t_p$ limited by $T_{jmax}$	$I_{CM}$	180	A
Power dissipation, $T_j = 25^\circ\text{C}$	$P_{tot}$	312	W
Operating junction temperature	$T_j$	-40...+175	$^\circ\text{C}$
Storage temperature	$T_S$	-55...+175	$^\circ\text{C}$
Soldering temperature, wave soldering 1.6mm (0.063in.) from case for 10s	-	260	$^\circ\text{C}$
Mounting torque, M3 screw Maximum of mounting processes: 3	$M$	0.6	Nm

**Thermal Resistance**

Parameter	Symbol	Max. Value	Unit
IGBT thermal resistance, junction - case	$R_{\theta(j-c)}$	0.48	K/W
Diode thermal resistance, junction - case	$R_{\theta(j-c)}$	1.1	K/W
Thermal resistance, junction - ambient	$R_{\theta(j-a)}$	40	K/W

**Electrical Characteristics** ( $T_j = 25^\circ\text{C}$  unless otherwise specified)

Parameter	Symbol	Conditions	Min	Typ	Max	Unit
<b>Static</b>						
Collector-Emitter Breakdown Voltage	$BV_{CES}$	$V_{GE}=0V, I_C=250\mu A$	650	-	-	V
		$V_{GE}=0V, I_C=1mA$	650	-	-	V
Gate Threshold Voltage	$V_{GE(th)}$	$V_{GE}=V_{CE}, I_C=250\mu A$	4.0	5.0	6.0	V
Collector-Emitter Saturation Voltage	$V_{CE(sat)}$	$V_{GE}=15V, I_C=60A$	-	1.85	2.2	V
		$T_j = 175^\circ\text{C}$	-	2.53	-	
Zero gate voltage collector current	$I_{CES}$	$V_{CE} = 650V, V_{GE} = 0V$	-	0.1	40	$\mu A$
		$T_j = 175^\circ\text{C}$	-	-	4000	
Gate-emitter leakage current	$I_{GES}$	$V_{CE} = 0V, V_{GE} = \pm 20V$	-	-	100	nA
Transconductance	$g_{fs}$	$V_{CE} = 20V, I_C = 60A$	-	52	-	S

Parameter	Symbol	Conditions	Min	Typ	Max	Unit
<b>Dynamic</b>						
Input capacitance	$C_{ies}$	$V_{CE} = 30V, V_{GE} = 0V,$ $f = 1\text{ MHz}$	-	3800	-	pF
Output capacitance	$C_{oes}$		-	130	-	
Reverse transfer capacitance	$C_{res}$		-	70	-	
Gate charge	$Q_G$	$V_{CC} = 520V, I_C = 60A,$ $V_{GE} = 15V$	-	158	-	nC

## Switching Characteristic, Inductive Load

Parameter	Symbol	Conditions	Min	Typ	Max	Unit
<b>Dynamic</b> $T_j=25^\circ\text{C}$						
Turn-on Delay Time	$t_{d(\text{on})}$	$V_{CC} = 400\text{V}, I_C = 60.0\text{A},$ $V_{GE} = 0.0/15.0\text{V},$ $R_g=12\Omega$	-	56	-	ns
Rise Time	$t_r$		-	79	-	ns
Turn-off Delay Time	$t_{d(\text{off})}$		-	165	-	ns
Fall Time	$t_f$		-	81	-	ns
Turn-on Energy	$E_{\text{on}}$		-	2.2	-	mJ
Turn-off Energy	$E_{\text{off}}$		-	0.89	-	mJ

## Electrical Characteristics of the DIODE ( $T_j = 25^\circ\text{C}$ unless otherwise specified)

Parameter	Symbol	Conditions	Min	Typ	Max	Unit
<b>Dynamic</b>						
Diode Forward Voltage	$V_{FM}$	$I_F = 60\text{A}$	-	2.0	-	v
Reverse Recovery Time	$T_{rr}$	$I_F = 50\text{A},$ $V_R = 400\text{V},$ $di/dt = 100\text{A}/\mu\text{s},$	-	20	-	ns
Reverse Recovery Current	$I_{rr}$		-	10	-	A
Reverse Recovery Charge	$Q_{rr}$		-	100	-	nC

Fig. 1 FBSOA characteristics

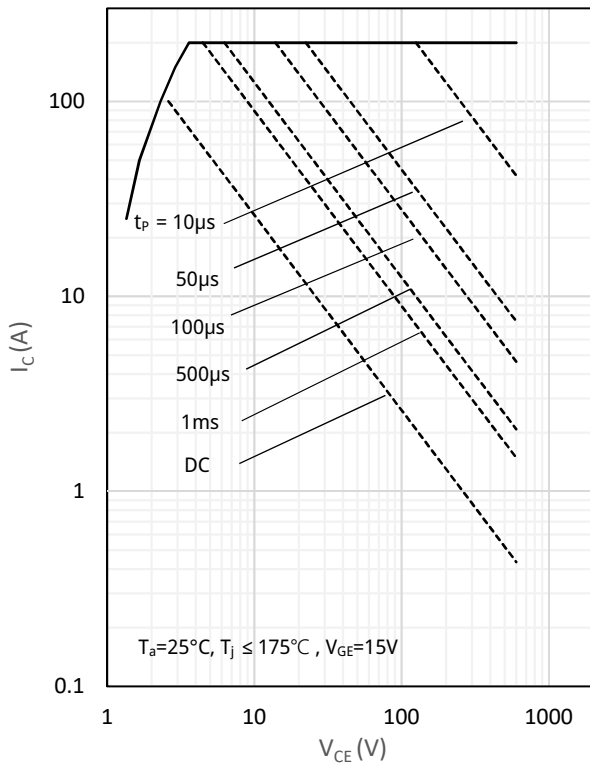

Fig. 2 Power dissipation as a function of  $T_c$

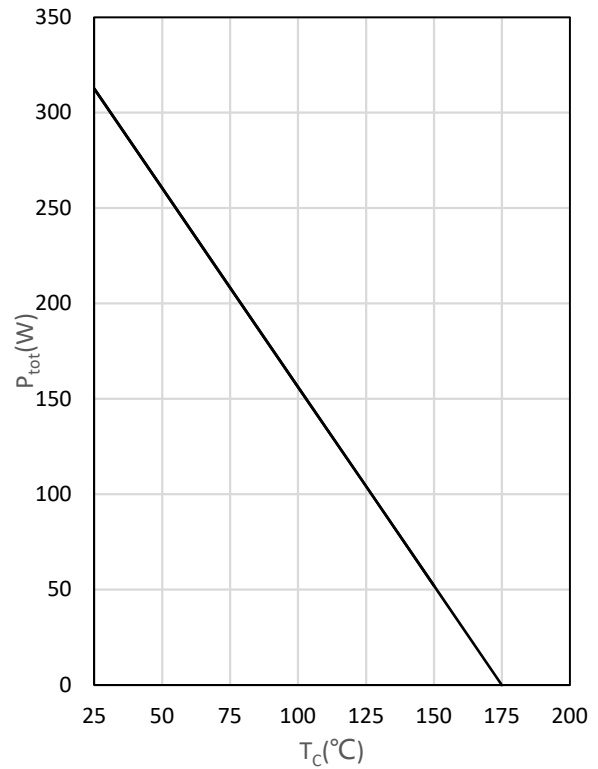

Fig. 3 Output characteristics

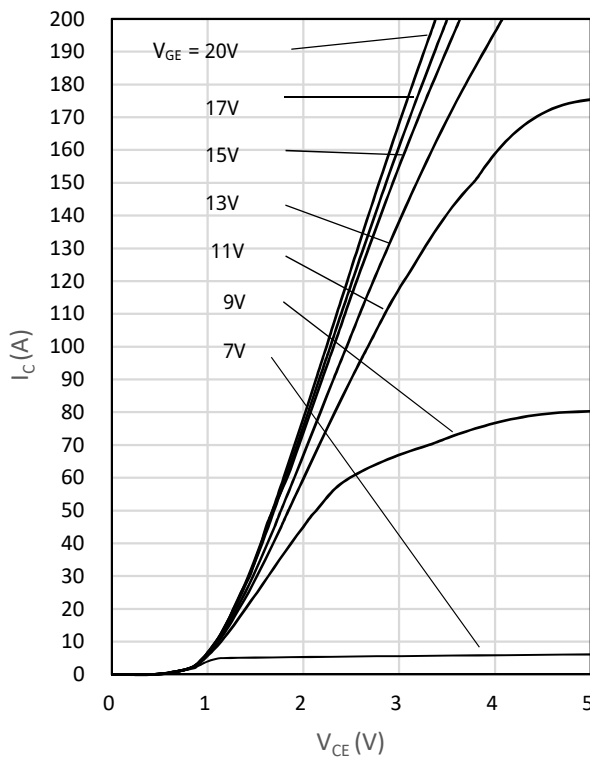

Fig. 4 Saturation voltage characteristics

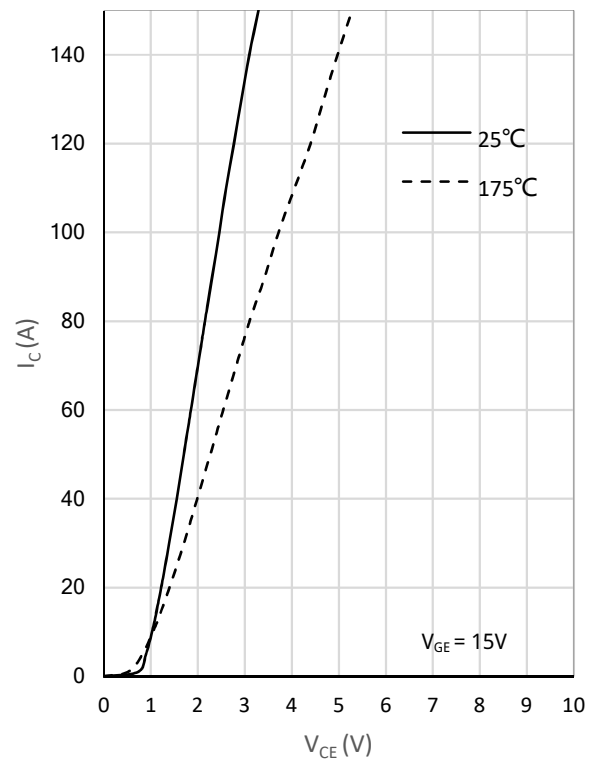

Fig. 5 Switching times vs. gate resistor

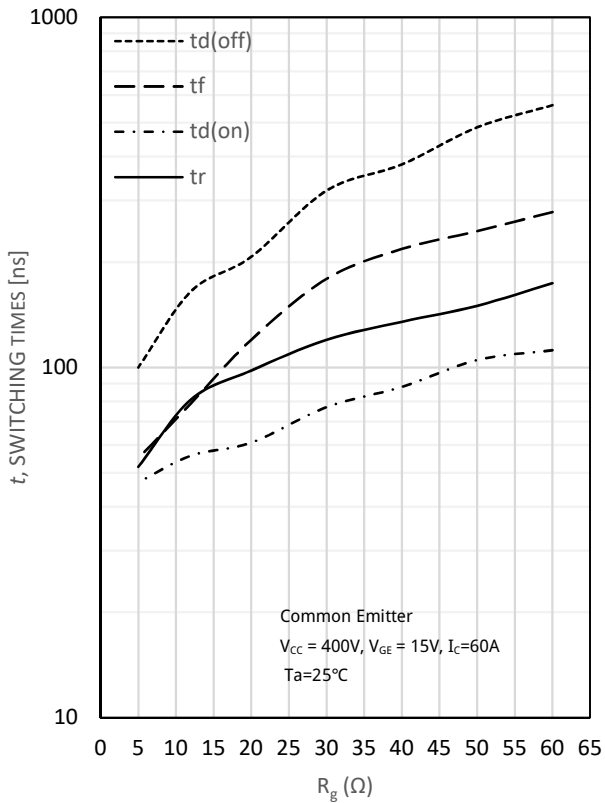

Fig. 6 Switching times vs. collector current

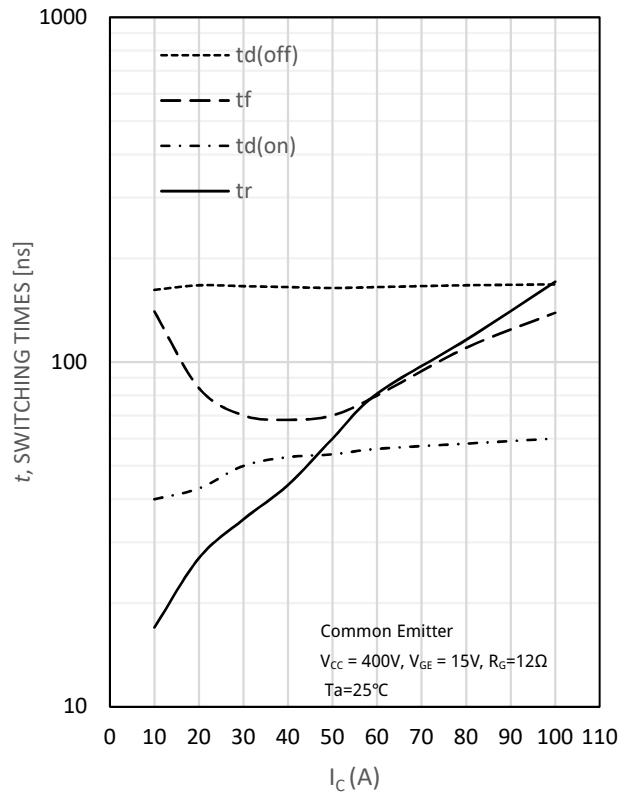

Fig. 7 Switching loss vs. gate resistor

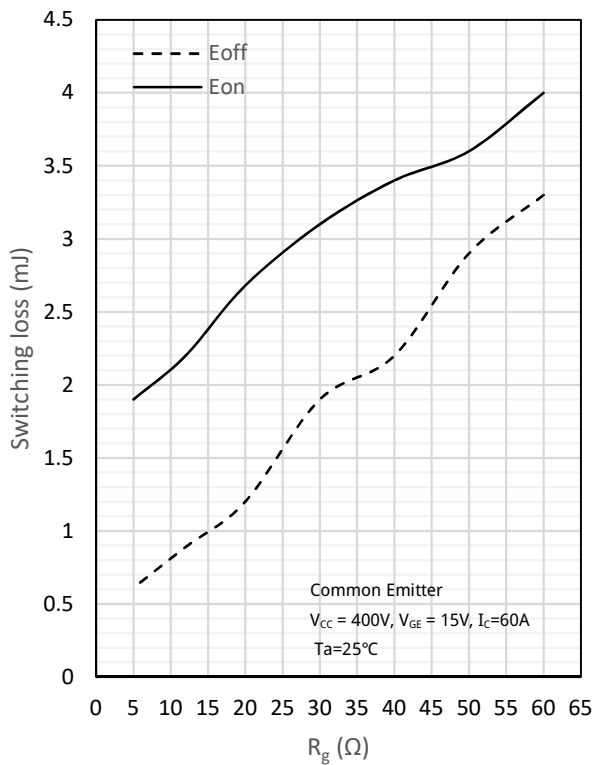

Fig. 8 Switching loss vs. collector current

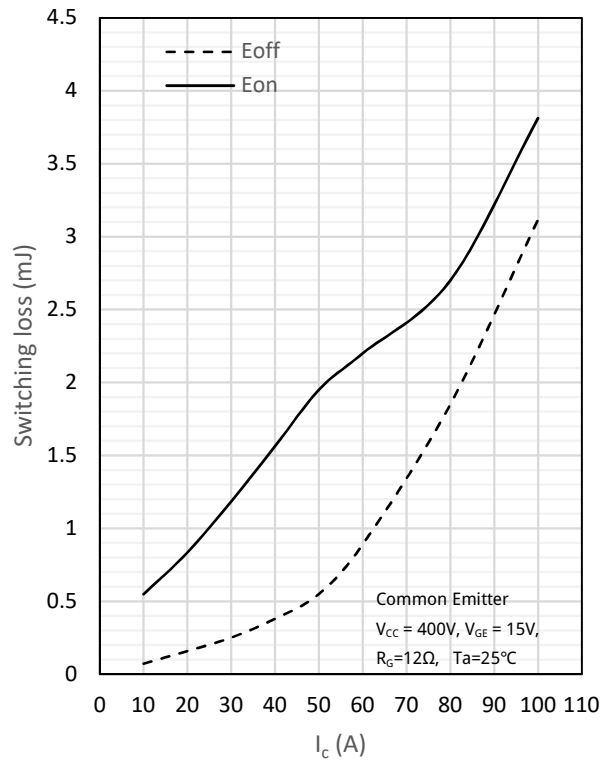

Fig. 9 Gate charge characteristics

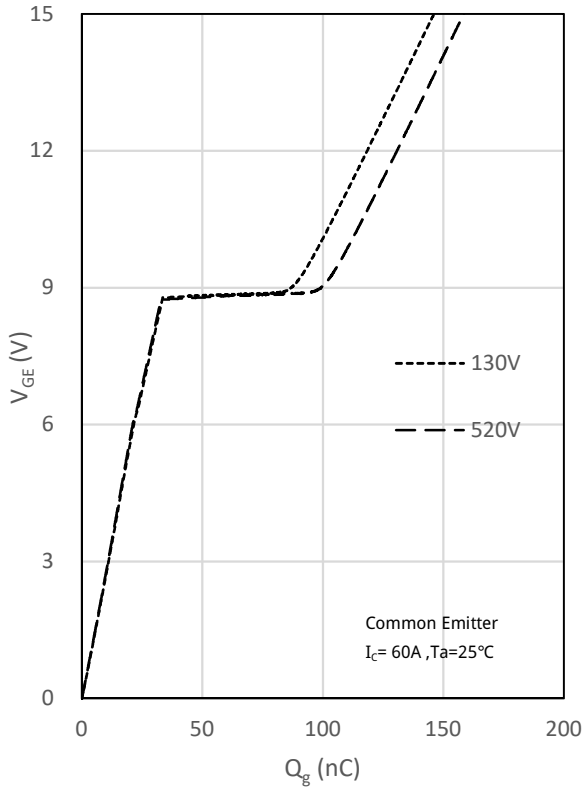
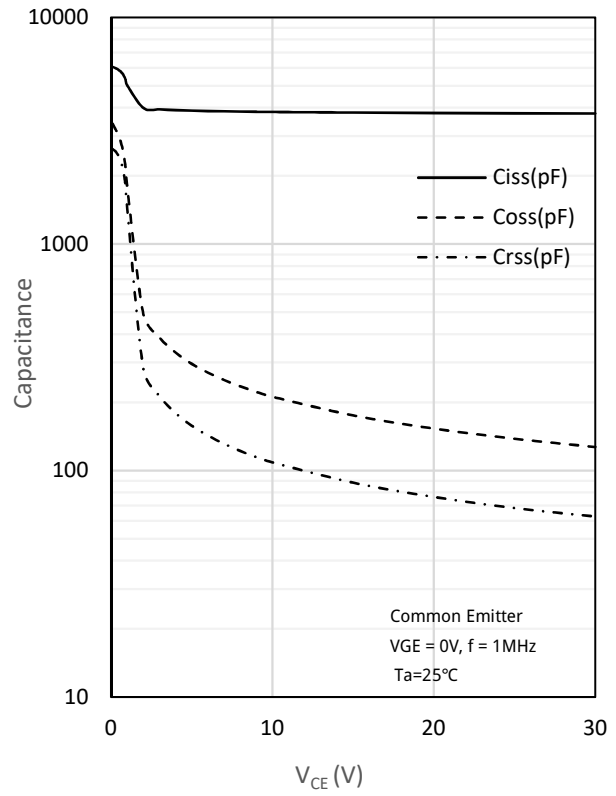
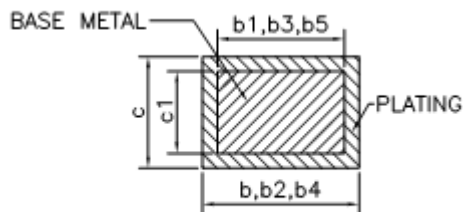
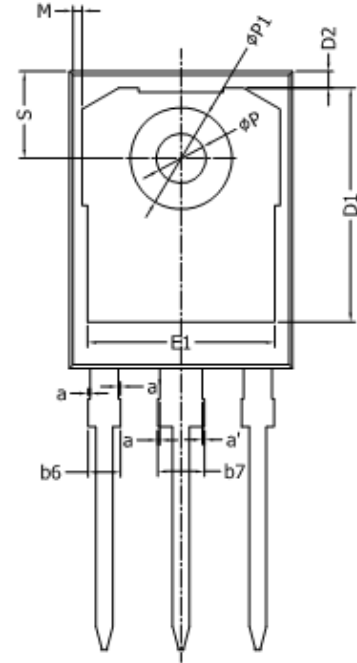
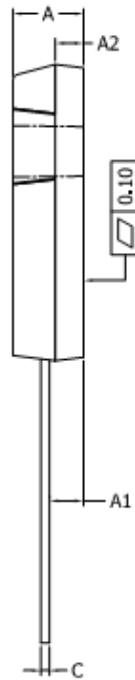
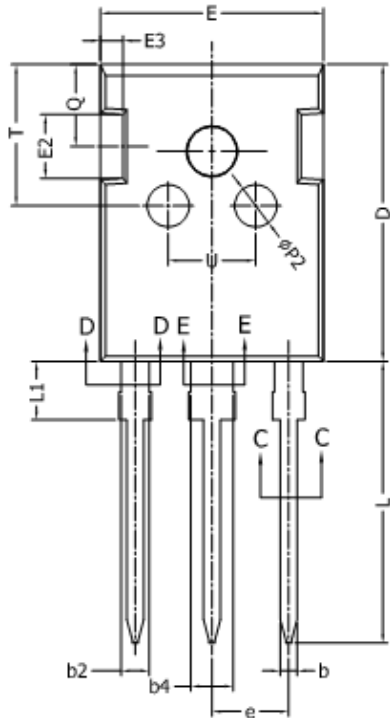

Fig. 10 Capacitance characteristics



## TO247 package information



SECTION C-C, D-D & E-E

COMMON DIMENSIONS  
(UNITS OF MEASURE =MILLIMETER)

SYMBOL	MIN	NOM	MAX
A	4.90	5.00	5.10
A1	2.31	2.41	2.51
A2	1.90	2.00	2.10
a	0	--	0.15
a'	0	--	0.15
b	1.16	--	1.26
b1	1.15	1.2	1.22
b2	1.96	--	2.06
b3	1.95	2.00	2.02
b4	2.96	--	3.06
b5	2.96	3.00	3.02
b6	2.00	--	2.25
b7	3.00	--	3.25
c	0.59	--	0.66
c1	0.58	0.60	0.62
D	20.90	21.00	21.10
D1	16.25	16.55	16.85
D2	1.05	1.17	1.35
E	15.70	15.80	15.90
E1	13.10	13.30	13.50
E2	4.40	4.50	4.60
E3	1.50	1.60	1.70
e	5.336	5.436	5.53
L	19.80	19.92	20.10
L1	4.10	--	4.30
M	0.35	--	0.95
P	3.40	3.50	3.60
P1	7.00	--	7.40
P2	2.40	2.50	2.60
Q	5.60	--	6.00
S	6.05	6.15	6.25
T	9.80	--	10.20
U	6.00	--	6.40