

## HEXFET® Power MOSFET

- Surface Mount
- Available in Tape & Reel
- Dynamic  $dv/dt$  Rating
- Repetitive Avalanche Rated
- Fast Switching
- Ease of Paralleling
- Simple Drive Requirements

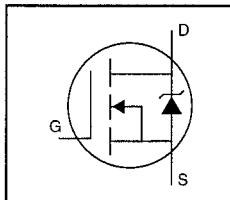

$$V_{DSS} = 500V$$

$$R_{DS(on)} = 0.85\Omega$$

$$I_D = 8.0A$$

### Description

Third Generation HEXFETs from International Rectifier provide the designer with the best combination of fast switching, ruggedized device design, low on-resistance and cost-effectiveness.

The SMD-220 is a surface mount power package capable of accommodating die sizes up to HEX-4. It provides the highest power capability and the lowest possible on-resistance in any existing surface mount package. The SMD-220 is suitable for high current applications because of its low internal connection resistance and can dissipate up to 2.0W in a typical surface mount application.

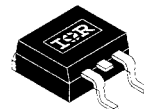

SMD-220

### Absolute Maximum Ratings

	Parameter	Max.	Units
$I_D @ T_C = 25^\circ C$	Continuous Drain Current, $V_{GS} @ 10 V$	8.0	A
$I_D @ T_C = 100^\circ C$	Continuous Drain Current, $V_{GS} @ 10 V$	5.1	
$I_{DM}$	Pulsed Drain Current ①	32	
$P_D @ T_C = 25^\circ C$	Power Dissipation	125	W
$P_D @ T_A = 25^\circ C$	Power Dissipation (PCB Mount)**	3.1	
	Linear Derating Factor	1.0	W/°C
	Linear Derating Factor (PCB Mount)**	0.025	
$V_{GS}$	Gate-to-Source Voltage	$\pm 20$	V
$E_{AS}$	Single Pulse Avalanche Energy ②	510	mJ
$I_{AR}$	Avalanche Current ①	8.0	A
$E_{AR}$	Repetitive Avalanche Energy ①	13	mJ
$dv/dt$	Peak Diode Recovery $dv/dt$ ③	3.5	V/ns
$T_J, T_{STG}$	Junction and Storage Temperature Range	-55 to +150	°C
	Soldering Temperature, for 10 seconds	300 (1.6mm from case)	

### Thermal Resistance

	Parameter	Min.	Typ.	Max.	Units
$R_{\theta JC}$	Junction-to-Case	—	—	1.0	°C/W
$R_{\theta JA}$	Junction-to-Ambient (PCB mount)**	—	—	40	
$R_{\theta JA}$	Junction-to-Ambient	—	—	62	

\*\* When mounted on 1" square PCB (FR-4 or G-10 Material).

For recommended footprint and soldering techniques refer to application note #AN-994.

## Electrical Characteristics @ $T_J = 25^\circ\text{C}$ (unless otherwise specified)

	Parameter	Min.	Typ.	Max.	Units	Test Conditions
$V_{(BR)DSS}$	Drain-to-Source Breakdown Voltage	500	—	—	V	$V_{GS}=0\text{V}$ , $I_D=250\mu\text{A}$
$\Delta V_{(BR)DSS}/\Delta T_J$	Breakdown Voltage Temp. Coefficient	—	0.78	—	$^\circ\text{V}/^\circ\text{C}$	Reference to $25^\circ\text{C}$ , $I_D=1\text{mA}$
$R_{DS(on)}$	Static Drain-to-Source On-Resistance	—	—	0.85	$\Omega$	$V_{GS}=10\text{V}$ , $I_D=4.8\text{A}$ ④
$V_{GS(th)}$	Gate Threshold Voltage	2.0	—	4.0	V	$V_{DS}=V_{GS}$ , $I_D=250\mu\text{A}$
$g_{fs}$	Forward Transconductance	4.9	—	—	S	$V_{DS}=50\text{V}$ , $I_D=4.8\text{A}$ ④
$I_{DSS}$	Drain-to-Source Leakage Current	—	—	25	$\mu\text{A}$	$V_{DS}=500\text{V}$ , $V_{GS}=0\text{V}$
		—	—	250		$V_{DS}=400\text{V}$ , $V_{GS}=0\text{V}$ , $T_J=125^\circ\text{C}$
$I_{GSS}$	Gate-to-Source Forward Leakage	—	—	100	nA	$V_{GS}=20\text{V}$
	Gate-to-Source Reverse Leakage	—	—	-100		$V_{GS}=-20\text{V}$
$Q_g$	Total Gate Charge	—	—	63	nC	$I_D=8.0\text{A}$
$Q_{gs}$	Gate-to-Source Charge	—	—	9.3		$V_{DS}=400\text{V}$
$Q_{gd}$	Gate-to-Drain ("Miller") Charge	—	—	32		$V_{GS}=10\text{V}$ See Fig. 6 and 13 ④
$t_{d(on)}$	Turn-On Delay Time	—	14	—		$V_{DD}=250\text{V}$
$t_r$	Rise Time	—	23	—	ns	$I_D=8.0\text{A}$
$t_{d(off)}$	Turn-Off Delay Time	—	49	—		$R_G=9.1\Omega$
$t_f$	Fall Time	—	20	—		$R_D=31\Omega$ See Figure 10 ④
$L_D$	Internal Drain Inductance	—	4.5	—	nH	Between lead, 6 mm (0.25in.) from package and center of die contact 
$L_S$	Internal Source Inductance	—	7.5	—		
$C_{iss}$	Input Capacitance	—	1300	—	pF	$V_{GS}=0\text{V}$
$C_{oss}$	Output Capacitance	—	310	—		$V_{DS}=25\text{V}$
$C_{rss}$	Reverse Transfer Capacitance	—	120	—		$f=1.0\text{MHz}$ See Figure 5

## Source-Drain Ratings and Characteristics

	Parameter	Min.	Typ.	Max.	Units	Test Conditions
$I_S$	Continuous Source Current (Body Diode)	—	—	8.0	A	MOSFET symbol showing the integral reverse p-n junction diode. 
$I_{SM}$	Pulsed Source Current (Body Diode) ①	—	—	32		
$V_{SD}$	Diode Forward Voltage	—	—	2.0	V	$T_J=25^\circ\text{C}$ , $I_S=8.0\text{A}$ , $V_{GS}=0\text{V}$ ④
$t_{rr}$	Reverse Recovery Time	—	460	970	ns	$T_J=25^\circ\text{C}$ , $I_F=8.0\text{A}$
$Q_{rr}$	Reverse Recovery Charge	—	4.2	8.9	$\mu\text{C}$	$di/dt=100\text{A}/\mu\text{s}$ ④
$t_{on}$	Forward Turn-On Time	Intrinsic turn-on time is negligible (turn-on is dominated by $L_S+L_D$ )				

### Notes:

- ① Repetitive rating; pulse width limited by max. junction temperature (See Figure 11)
- ②  $V_{DD}=50\text{V}$ , starting  $T_J=25^\circ\text{C}$ ,  $L=14\text{mH}$ ,  $R_G=25\Omega$ ,  $I_{AS}=8.0\text{A}$  (See Figure 12)
- ③  $I_{SD}\leq 8.0\text{A}$ ,  $di/dt\leq 100\text{A}/\mu\text{s}$ ,  $V_{DD}\leq V_{(BR)DSS}$ ,  $T_J\leq 150^\circ\text{C}$
- ④ Pulse width  $\leq 300\mu\text{s}$ ; duty cycle  $\leq 2\%$ .

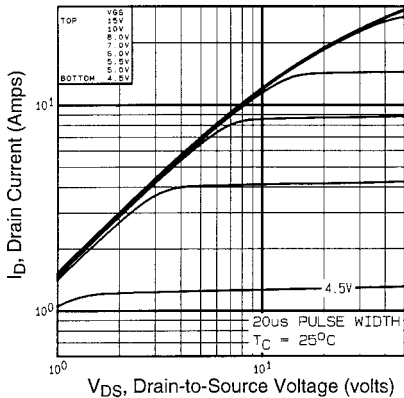

**Fig 1.** Typical Output Characteristics,  
 $T_C=25^\circ\text{C}$

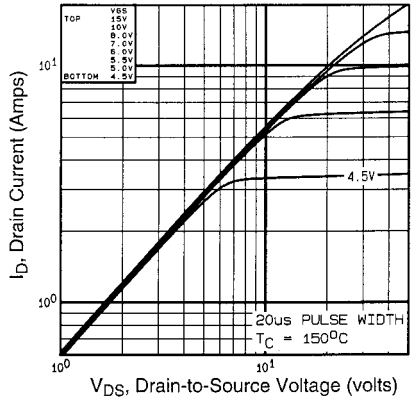

**Fig 2.** Typical Output Characteristics,  
 $T_C=150^\circ\text{C}$

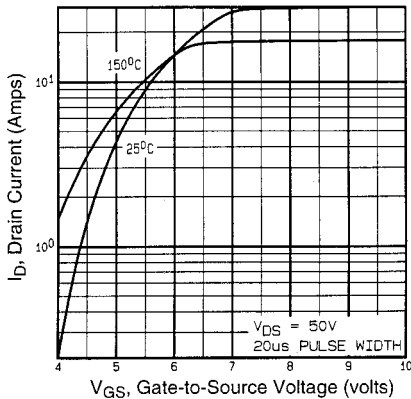

**Fig 3.** Typical Transfer Characteristics

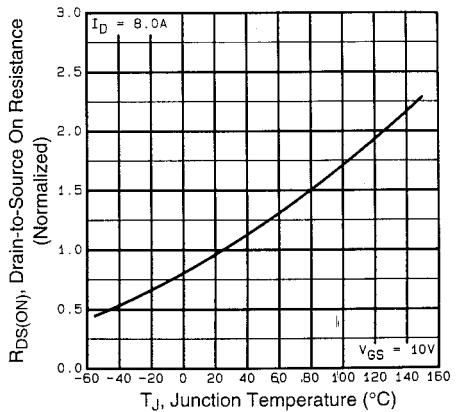

**Fig 4.** Normalized On-Resistance  
Vs. Temperature

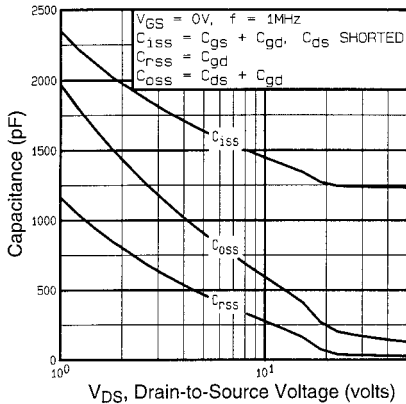

**Fig 5.** Typical Capacitance Vs. Drain-to-Source Voltage

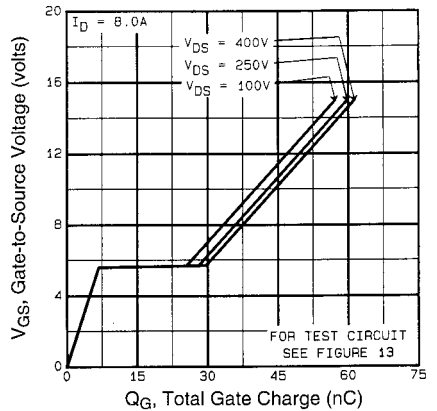

**Fig 6.** Typical Gate Charge Vs. Gate-to-Source Voltage

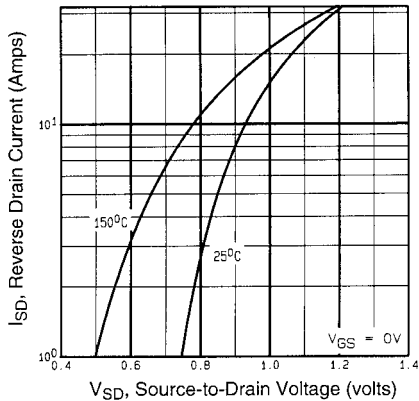

**Fig 7.** Typical Source-Drain Diode Forward Voltage

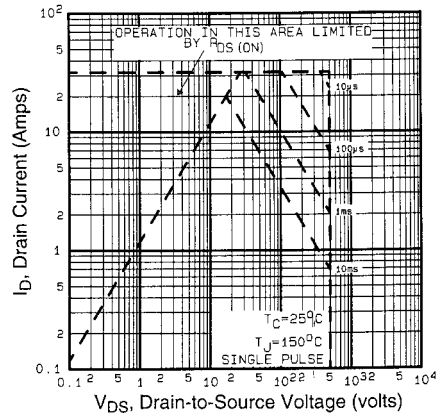

**Fig 8.** Maximum Safe Operating Area

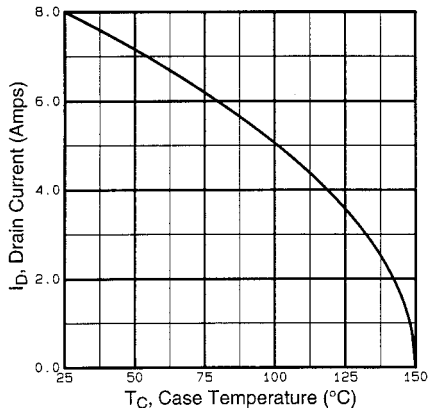

**Fig 9.** Maximum Drain Current Vs. Case Temperature

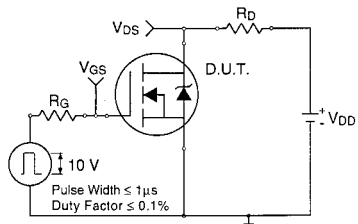

**Fig 10a.** Switching Time Test Circuit

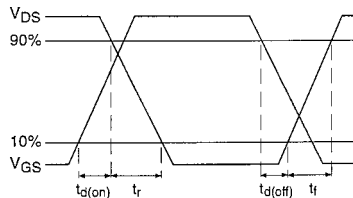

**Fig 10b.** Switching Time Waveforms

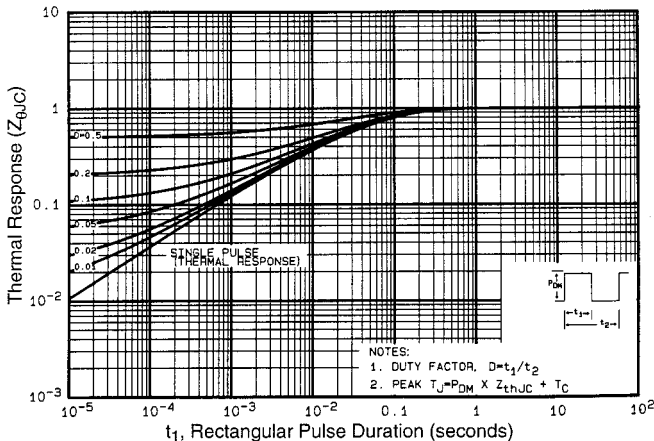

**Fig 11.** Maximum Effective Transient Thermal Impedance, Junction-to-Case

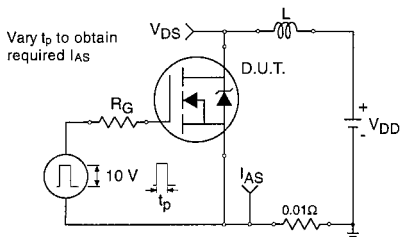

**Fig 12a.** Unclamped Inductive Test Circuit

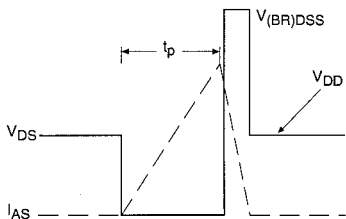

**Fig 12b.** Unclamped Inductive Waveforms

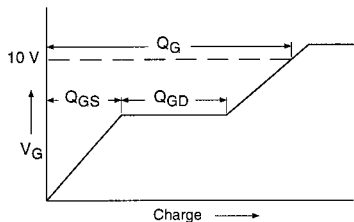

**Fig 13a.** Basic Gate Charge Waveform

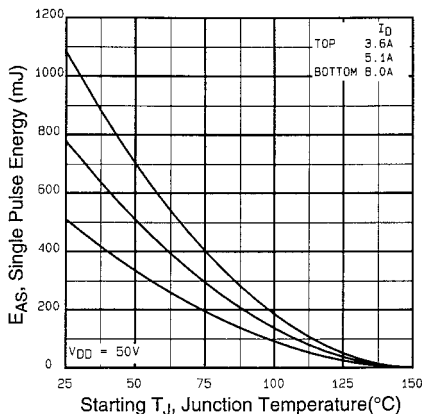

**Fig 12c.** Maximum Avalanche Energy Vs. Drain Current

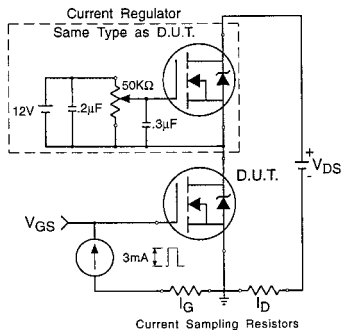

**Fig 13b.** Gate Charge Test Circuit

**Appendix A:** Figure 14, Peak Diode Recovery  $dv/dt$  Test Circuit

**Appendix B:** Package Outline Mechanical Drawing

**Appendix C:** Part Marking Information

**Appendix D:** Tape & Reel Information