

Analog Devices Welcomes Hittite Microwave Corporation

NO CONTENT ON THE ATTACHED DOCUMENT HAS CHANGED



THIS PAGE INTENTIONALLY LEFT BLANK



GaAs InGaP HBT MMIC ULTRA LOW PHASE NOISE, DISTRIBUTED AMPLIFIER, 2 - 18 GHz

Typical Applications

The HMC606LC5 is ideal for:

- Radar, EW & ECM
- Microwave Radio
- Test Instrumentation
- Military & Space
- Fiber Optic Systems

Features

- Ultra Low Phase Noise: -160 dBc/Hz @ 10 kHz
- P1dB Output Power: +15 dBm
- Gain: 13.5 dB
- Output IP3: +27 dBm
- Supply Voltage: +5V @ 64 mA
- 50 Ohm Matched Input/Output
- 32 Lead Ceramic 5x5mm SMT Package: 25mm²

Functional Diagram

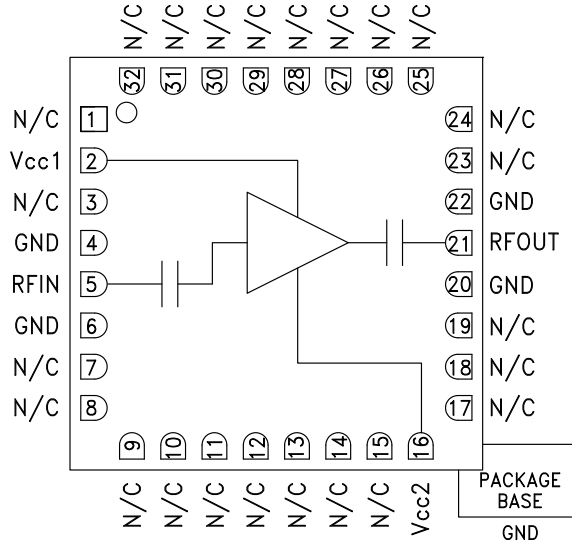

General Description

The HMC606LC5 is a GaAs InGaP HBT MMIC Distributed Amplifier housed in a leadless 5x5 mm surface mount package which operates between 2 and 18 GHz. With an input signal of 12 GHz, the amplifier provides ultra low phase noise performance of -160 dBc/Hz at 10 kHz offset, representing a significant improvement over FET-based distributed amplifiers. The HMC606LC5 provides 13.5 dB of small signal gain, +27 dBm output IP3 and +15 dBm of output power at 1 dB gain compression while requiring 64 mA from a +5V supply. The HMC606LC5 amplifier I/Os are internally matched to 50 Ohms and are internally DC blocked.

Electrical Specifications, $T_A = +25^\circ\text{C}$, $V_{cc1} = V_{cc2} = 5V$

Parameter	Min.	Typ.	Max.	Min.	Typ.	Max.	Units
Frequency Range	2 - 12			2 - 18			GHz
Gain	10.5	13.5		9.5	12.5		dB
Gain Flatness		±1.0			±1.0		dB
Gain Variation Over Temperature		0.021			0.024		dB/ °C
Noise Figure		5			7		dB
Input Return Loss		20			18		dB
Output Return Loss		15			15		dB
Output Power for 1 dB Compression (P1dB)	12	15		10	13		dBm
Saturated Output Power (Psat)		17			15		dBm
Output Third Order Intercept (IP3)		27			22		dBm
Phase Noise @ 100 Hz		-140			-140		dBc/Hz
Phase Noise @ 1 kHz		-150			-150		dBc/Hz
Phase Noise @ 10 kHz		-160			-160		dBc/Hz
Phase Noise @ 1 MHz		-170			-170		dBc/Hz
Supply Current		64	95		64	95	mA

For price, delivery and to place orders: Hittite Microwave Corporation, 2 Elizabeth Drive, Chelmsford, MA 01824

Phone: 978-250-3343 Fax: 978-250-3373 Order On-line at www.hittite.com

Application Support: Phone: 978-250-3343 or apps@hittite.com

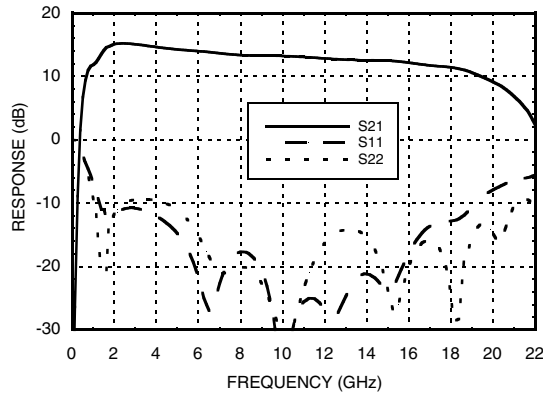
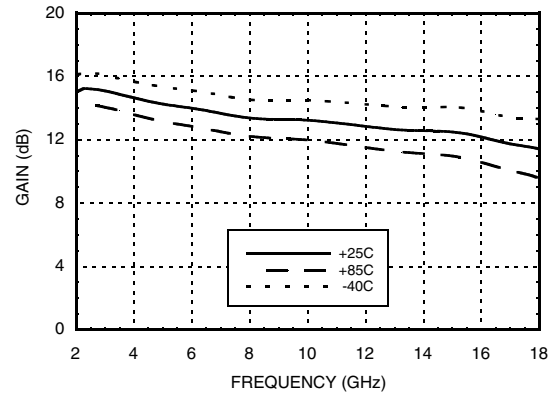
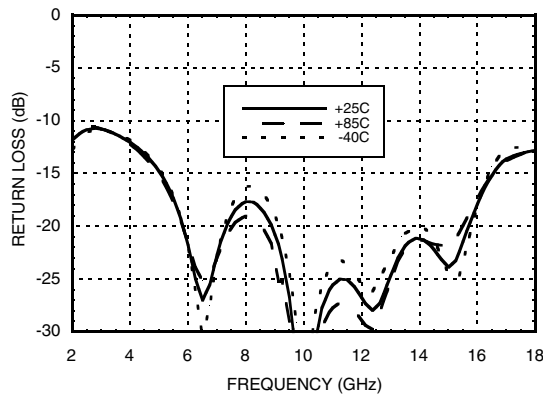
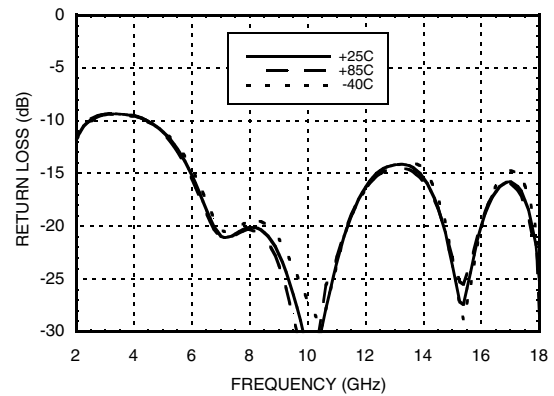
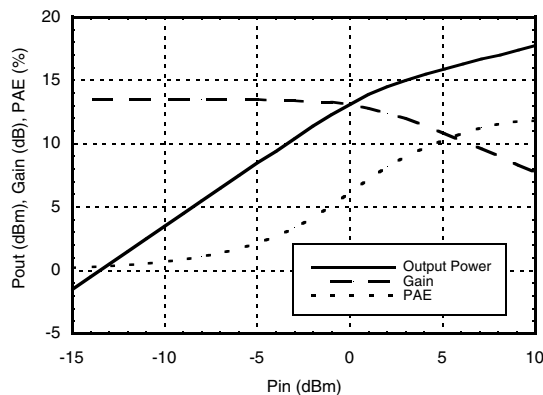
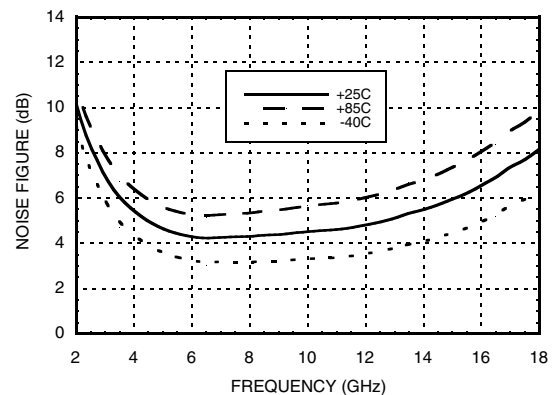
**GaAs InGaP HBT MMIC ULTRA LOW
PHASE NOISE, DISTRIBUTED AMPLIFIER, 2 - 18 GHz**
Gain & Return Loss

Gain vs. Temperature

Input Return Loss vs. Temperature

Output Return Loss vs. Temperature

Power Compression

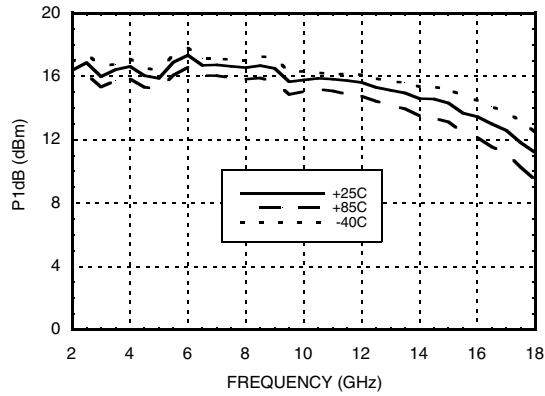
Noise Figure vs. Temperature



GaAs InGaP HBT MMIC ULTRA LOW PHASE NOISE, DISTRIBUTED AMPLIFIER, 2 - 18 GHz

LOW NOISE AMPLIFIERS - SMT

P1dB vs. Temperature



Psat vs. Temperature

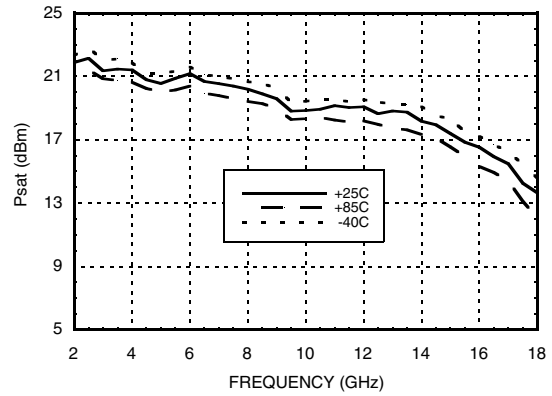

Output IP3 vs. Temperature

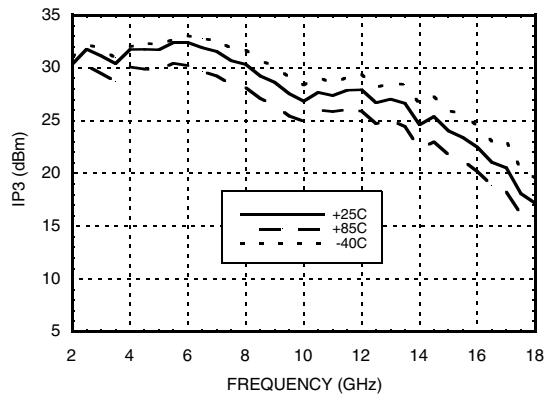

Phase Noise @ 12 GHz

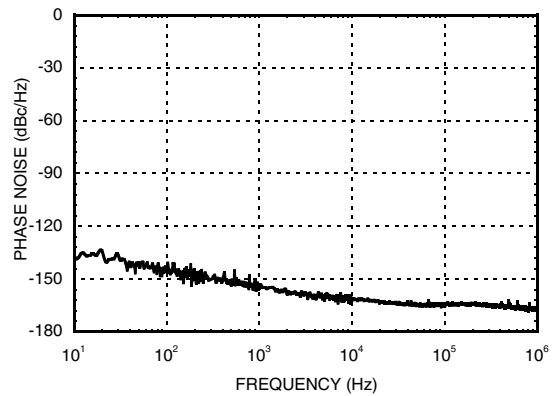

Phase Noise at P1dB @ 12 GHz

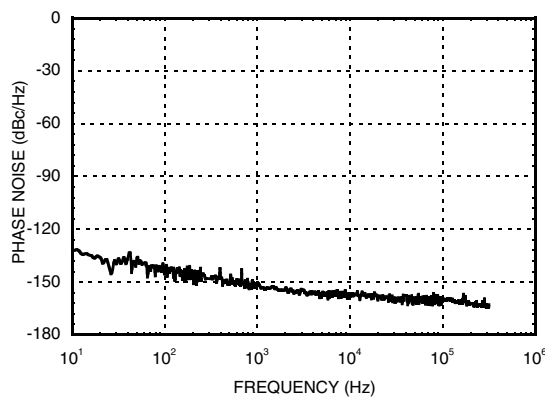

Phase Noise at Psat @ 12 GHz

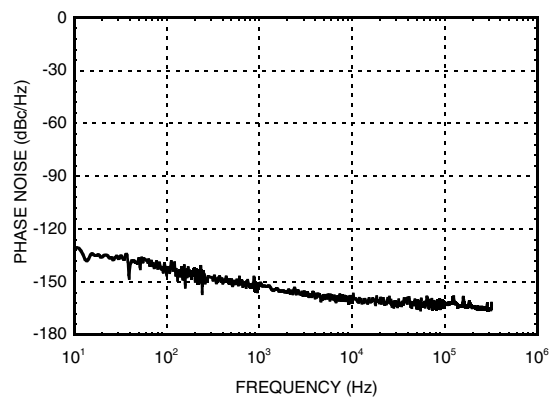



GaAs InGaP HBT MMIC ULTRA LOW PHASE NOISE, DISTRIBUTED AMPLIFIER, 2 - 18 GHz

Absolute Maximum Ratings

Vcc1= Vcc2	7V
RF Input Power (RFIN)	+15 dBm
Channel Temperature	175 °C
Continuous P _{diss} (T = 85 °C) (derate 6 mW/°C above 85 °C)	0.55 W
Thermal Resistance (channel to ground paddle)	169.5 °C/W
Storage Temperature	-65 to +150 °C
Operating Temperature	-40 to +85 °C
ESD Sensitivity (HBM)	Class 0, Pass 100V

Typical Supply Current vs. Vcc1, Vcc2

Vcc1, Vcc2 (V)	Icc1 + Icc2 (mA)
+4.5	53
+5.0	64
+5.5	71



ELECTROSTATIC SENSITIVE DEVICE
OBSERVE HANDLING PRECAUTIONS

Outline Drawing

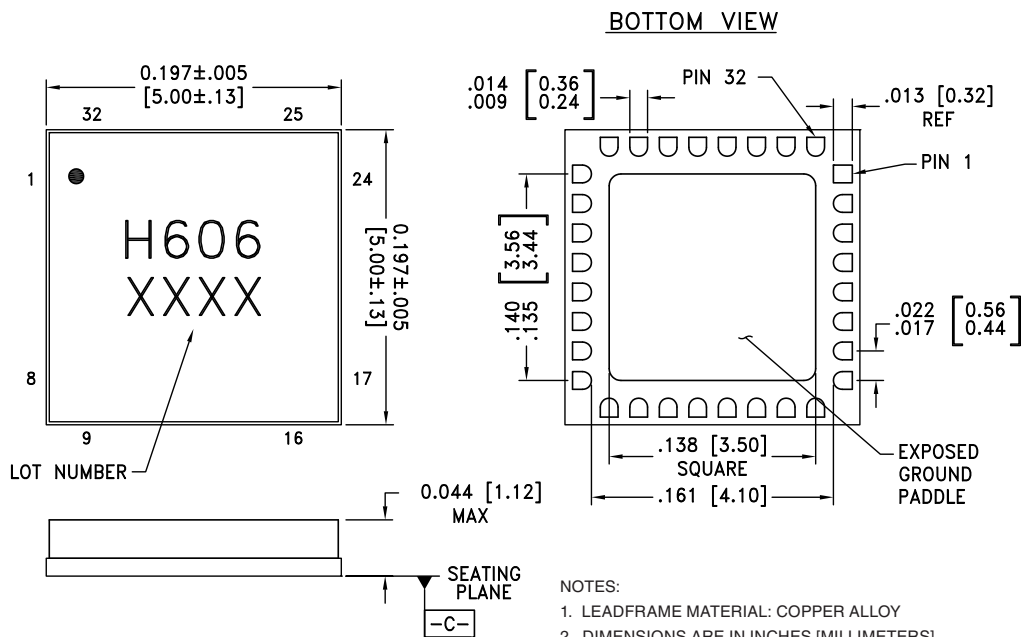

Package Information

Part Number	Package Body Material	Lead Finish	MSL Rating	Package Marking ^[2]
HMC606LC5	Alumina, White	Gold over Nickel	MSL3 ^[1]	H606 XXXX



[1] Max peak reflow temperature of 260 °C

[2] 4-Digit lot number XXXX

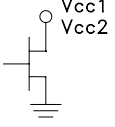

**GaAs InGaP HBT MMIC ULTRA LOW
PHASE NOISE, DISTRIBUTED AMPLIFIER, 2 - 18 GHz**

Pin Descriptions

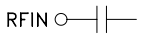
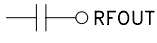
Pin Number	Function	Description	Interface Schematic
1, 3, 7 - 15, 17 - 19, 23 - 32	N/C	No connection. These pins may be connected to RF ground. Performance will not be affected.	
2, 16	Vcc1, Vcc2	Power supply voltage for the amplifier.	
4, 6, 20, 22 Ground Paddle	GND	Ground paddle must be connected to RF/DC ground.	
5	RFIN	This pin is AC coupled and matched to 50 Ohms.	
21	RFOUT	This pin is AC coupled and matched to 50 Ohms.	

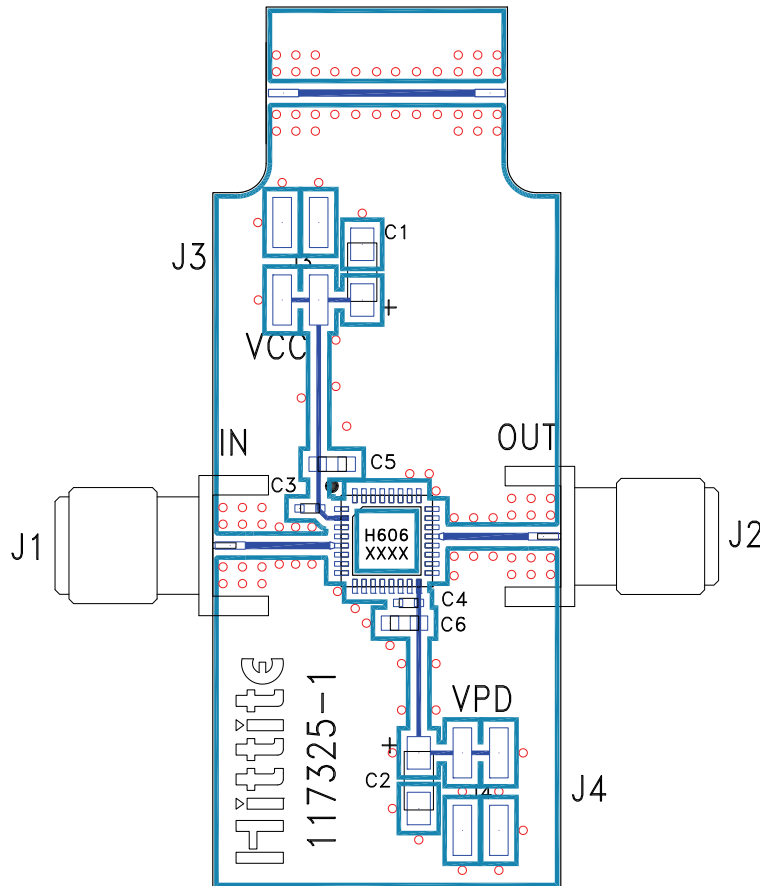

**GaAs InGaP HBT MMIC ULTRA LOW
PHASE NOISE, DISTRIBUTED AMPLIFIER, 2 - 18 GHz**

Evaluation PCB

List of Materials for Evaluation PCB 117156 [1]

Item	Description
J1 - J2	SRI K Connector
J3 - J4	2mm Molex Header
C1, C2	4.7 μ F Capacitor, Tantalum
C3, C4	100 pF Capacitor, 0402 Pkg.
C5, C6	1000 pF Capacitor, 0603 Pkg.
U1	HMC606LC5
PCB [2]	117325 Evaluation PCB

[1] Reference this number when ordering complete evaluation PCB

[2] Circuit Board Material: Rogers 4350

The circuit board used in the application should use RF circuit design techniques. Signal lines should have 50 Ohm impedance while the package ground leads and package bottom should be connected directly to the ground plane similar to that shown. A sufficient number of via holes should be used to connect the top and bottom ground planes. The evaluation board should be mounted to an appropriate heat sink. The evaluation circuit board shown is available from Hittite upon request.

Mouser Electronics

Authorized Distributor

Click to View Pricing, Inventory, Delivery & Lifecycle Information:

[Analog Devices Inc.:](#)

[HMC606LC5](#) [HMC606LC5TR](#)