

Features

- RoHS compliant*
- Protects up to four I/O ports
- Bidirectional configuration
- ESD protection
- Low capacitance: 6 pF

Applications

- Ethernet - 10/100/1000 Base T
- Personal digital assistants
- Handheld electronics
- Cellular phones
- Video cards

CDNBS08-SLVU2.8-8 - Low Capacitance TVS Array

General Information

The markets of portable communications, computing and video equipment are challenging the semiconductor industry to develop increasingly smaller electronic components.

Bourns offers Transient Voltage Suppressor Array combination diodes for surge and ESD protection applications in an eight lead narrow body SOIC package size format. Bourns® Chip Diodes conform to JEDEC standards, are easy to handle on standard pick and place equipment and their flat configuration minimizes roll away.

The Bourns® device will meet IEC 61000-4-2 (ESD), IEC 61000-4-4 (EFT) and IEC 61000-4-5 (Surge) requirements.

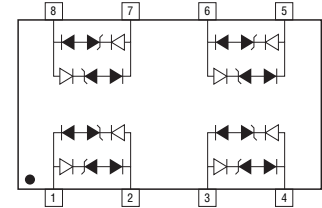

Electrical Characteristics (@ T_A = 25 °C Unless Otherwise Noted)

Parameter	Symbol	Min.	Nom.	Max.	Unit
Peak Pulse Current (t _p = 8/20 μs)	I _{PP}			30	A
Peak Pulse Power (t _p = 8/20 μs) ¹	P _{PP}			600	W
Working Voltage	V _{WM}			2.8	V
Breakdown Voltage @ 1 mA	V _{BR}	3.0			V
Leakage Current @ V _{WM}	I _D			1.0	μA
Capacitance @ 0 V, 1 MHz	C		6		pF
Snapback Voltage @ 50 mA		2.8			V
ESD Protection per IEC 61000-4-2 Contact Discharge Air Discharge	ESD	± 8 ± 15			kV
EFT Protection per IEC 61000-4-4 @ 5/50 ns	EFT			60	A
Surge Protection per IEC 61000-4-5 Clamping Voltage @ 8/20 μs	@ I _p = 5 A ²			8.5	V
	@ I _p = 24 A ²			15	V
	@ I _{PP} = 30 A ²			17	V

Notes:

1. See Peak Pulse Power vs. Pulse Time.
2. Each differential line pair.

Thermal Characteristics (@ T_A = 25 °C Unless Otherwise Noted)

Parameter	Symbol	Min.	Nom.	Max.	Unit
Junction Temperature Range	T _J	-55	+25	+125	°C
Storage Temperature Range	T _{STG}	-55	+25	+150	°C

*RoHS Directive 2002/95/EC Jan. 27, 2003 including annex and RoHS Recast 2011/65/EU June 8, 2011.
Specifications are subject to change without notice.

Customers should verify actual device performance in their specific applications.

CDNBS08-SLVU2.8-8 - Low Capacitance TVS Array



Product Dimensions

This is an RoHS compliant molded JEDEC narrow body SO-8 package with 100 % Sn plating on the lead frame. It weighs approximately 15 mg and has a flammability rating of UL 94V-0.

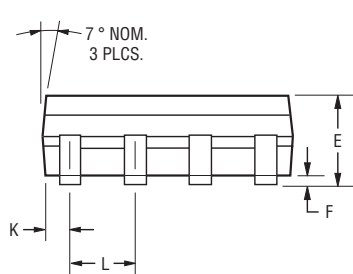
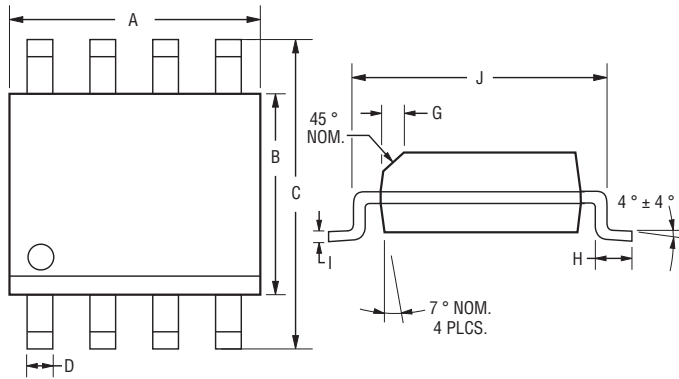

DIMENSIONS = $\frac{\text{MILLIMETERS}}{\text{(INCHES)}}$

Dimensions	
A	$\frac{4.80 - 5.00}{(0.189 - 0.197)}$
B	$\frac{3.81 - 4.00}{(0.150 - 0.157)}$
C	$\frac{5.80 - 6.20}{(0.228 \pm 0.244)}$
D	$\frac{0.36 - 0.51}{(0.014 - 0.020)}$
E	$\frac{1.35 - 1.75}{(0.053 - 0.069)}$
F	$\frac{0.102 - 0.203}{(0.004 - 0.008)}$
G	$\frac{0.25 - 0.50}{(0.010 - 0.020)}$
H	$\frac{0.51 - 1.12}{(0.020 - 0.044)}$
I	$\frac{0.190 - 0.229}{(0.0075 - 0.0090)}$
J	$\frac{4.60 - 5.21}{(0.181 - 0.205)}$
K	$\frac{0.28 - 0.79}{(0.011 - 0.031)}$
L	$\frac{1.27}{(0.050)}$

Recommended Footprint

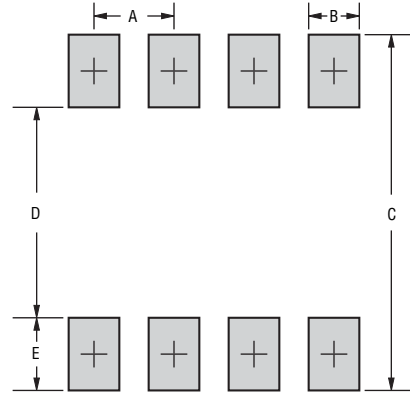

Dimensions	
A	$\frac{1.143 - 1.397}{(0.045 - 0.065)}$
B	$\frac{0.635 - 0.889}{(0.025 - 0.035)}$
C	$\frac{6.223}{(0.245)}$ Min.
D	$\frac{3.937 - 4.191}{(0.155 - 0.165)}$
E	$\frac{1.016 - 1.27}{(0.040 - 0.050)}$

Typical Part Marking

CDNBS08-SLVU2.8-8 **B** SL8

How to Order

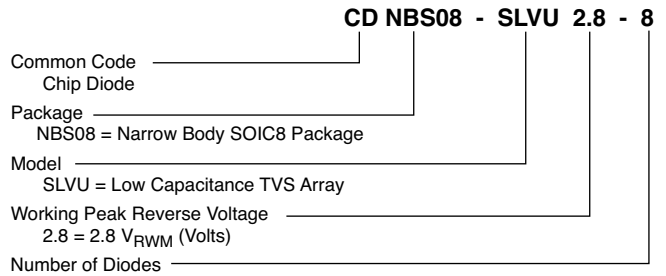

Specifications are subject to change without notice. Customers should verify actual device performance in their specific applications.

CDNBS08-SLVU2.8-8 - Low Capacitance TVS Array

Block Diagram

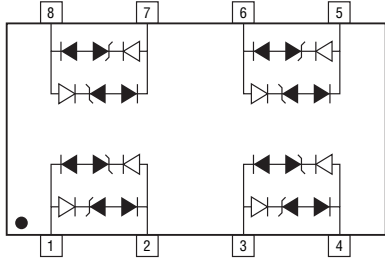

Device Pinout

Pin	Bidirectional Common Mode	Bidirectional Differential Mode
1	Line 1	Line Pair 1
2	GND	Line Pair 1
3	GND	Line Pair 2
4	Line 4	Line Pair 2
5	Line 3	Line Pair 4
6	GND	Line Pair 4
7	GND	Line Pair 3
8	Line 2	Line Pair 3

Performance Graphs

Peak Pulse Power vs Pulse Time

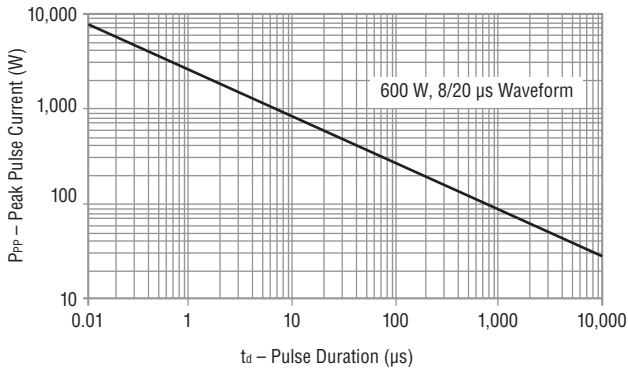

Pulse Waveform

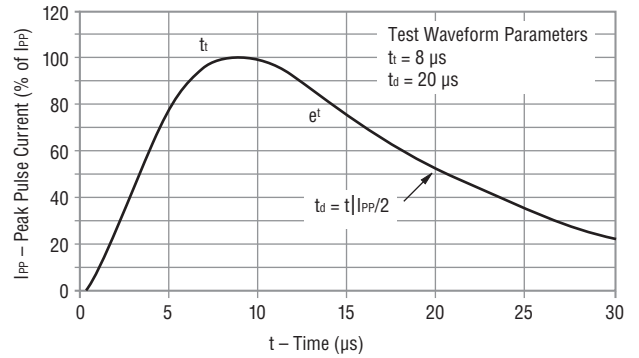

Power Derating Curve

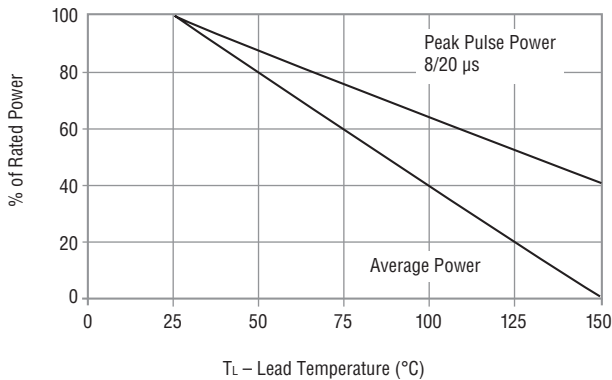

Specifications are subject to change without notice.
 Customers should verify actual device performance in their specific applications.

CDNBS08-SLVU2.8-8 - Low Capacitance TVS Array

BOURNS®

Packaging Information

The product is packaged in tape and reel format per EIA-481 standard.

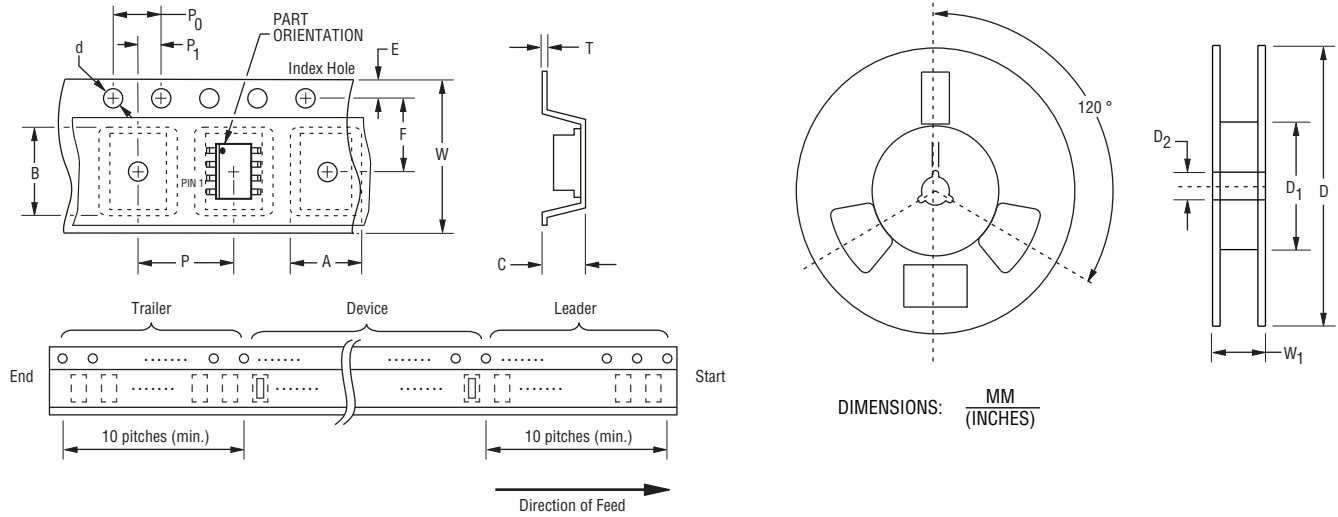

Item	Symbol	NSOIC 8L
Carrier Width	A	$\frac{6.7 \pm 0.10}{(0.264 \pm 0.004)}$
Carrier Length	B	$\frac{5.5 \pm 0.10}{(0.217 \pm 0.004)}$
Carrier Depth	C	$\frac{2.10 \pm 0.10}{(0.083 \pm 0.004)}$
Sprocket Hole	d	$\frac{1.55 \pm 0.05}{(0.061 \pm 0.002)}$
Reel Outside Diameter	D	$\frac{330}{(12.992)}$
Reel Inner Diameter	D ₁	$\frac{80.0}{(3.1500)}$ MIN.
Feed Hole Diameter	D ₂	$\frac{13.0 \pm 0.20}{(0.512 \pm 0.008)}$
Sprocket Hole Position	E	$\frac{1.75 \pm 0.10}{(0.069 \pm 0.004)}$
Punch Hole Position	F	$\frac{3.50 \pm 0.05}{(0.138 \pm 0.002)}$
Punch Hole Pitch	P	$\frac{8.00 \pm 0.10}{(0.315 \pm 0.004)}$
Sprocket Hole Pitch	P ₀	$\frac{4.00 \pm 0.10}{(0.157 \pm 0.004)}$
Embossment Center	P ₁	$\frac{2.00 \pm 0.05}{(0.079 \pm 0.002)}$
Overall Tape Thickness	T	$\frac{0.20 \pm 0.10}{(0.008 \pm 0.004)}$
Tape Width	W	$\frac{12.00 \pm 0.20}{(0.472 \pm 0.008)}$
Reel Width	W ₁	$\frac{18.4}{(0.724)}$ MAX.
Quantity per Reel	--	2500

BOURNS®

Asia-Pacific:

Tel: +886-2 2562-4117

Fax: +886-2 2562-4116

Europe:

Tel: +41-41 768 5555

Fax: +41-41 768 5510

The Americas:

Tel: +1-951 781-5500

Fax: +1-951 781-5700

www.bourns.com

REV. 12/12

Specifications are subject to change without notice.
Customers should verify actual device performance in their specific applications.

Mouser Electronics

Authorized Distributor

Click to View Pricing, Inventory, Delivery & Lifecycle Information:

Bourns:

[CDNBS08-SLVU2.8-8](#)