

NPN SILICON PLANAR MEDIUM POWER DARLINGTON TRANSISTORS

ZTX602
ZTX603

ISSUE 1 – MARCH 94

FEATURES

- * 80 Volt V_{CEO}
- * 1 Amp continuous current
- * Gain of 2K at $I_C=1$ Amp
- * $P_{tot} = 1$ Watt

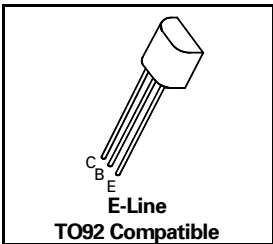

ABSOLUTE MAXIMUM RATINGS.

PARAMETER	SYMBOL	ZTX602	ZTX603	UNIT
Collector-Base Voltage	V_{CBO}	80	100	V
Collector-Emitter Voltage	V_{CEO}	60	80	V
Emitter-Base Voltage	V_{EBO}	10		V
Peak Pulse Current	I_{CM}	4		A
Continuous Collector Current	I_C	1		A
Power Dissipation at $T_{amb} = 25^\circ\text{C}$ derate above 25°C	P_{tot}	5.7		W mW/°C
Operating and Storage Temperature Range	$T_j; T_{stg}$	-55 to +200		°C

ELECTRICAL CHARACTERISTICS (at $T_{amb} = 25^\circ\text{C}$ unless otherwise stated).

PARAMETER	SYMBOL	ZTX602		ZTX603		UNIT	CONDITIONS.
		MIN.	MAX.	MIN.	MAX.		
Collector-Base Breakdown Voltage	$V_{(BR)CBO}$	80		100		V	$I_C=100\mu\text{A}$
Collector-Emitter Breakdown Voltage	$V_{(BR)CEO}$	60		80		V	$I_C=10\text{mA}^*$
Emitter-Base Breakdown Voltage	$V_{(BR)EBO}$	10		10		V	$I_E=100\mu\text{A}$
Collector Cut-Off Current	I_{CBO}		0.01 10		0.01 10	μA μA μA μA	$V_{CB}=60\text{V}$ $V_{CB}=80\text{V}$ $V_{CB}=60\text{V}, T_{amb}=100^\circ\text{C}$ $V_{CB}=80\text{V}, T_{amb}=100^\circ\text{C}$
Emitter Cut-Off Current	I_{EBO}		0.1		0.1	μA	$V_{EB}=8\text{V}$
Collector-Emitter Cut-Off Current	I_{CES}		10		10	μA μA	$V_{CES}=60\text{V}$ $V_{CES}=80\text{V}$
Collector-Emitter Saturation Voltage	$V_{CE(sat)}$		1.0 1.0		1.0 1.0	V V	$I_C=400\text{mA}$, $I_B=0.4\text{mA}^*$ $I_C=1\text{A}, I_B=1\text{mA}^*$
Base-Emitter Saturation Voltage	$V_{BE(sat)}$		1.8		1.8	V	$I_C=1\text{A}, I_B=1\text{mA}^*$
Base-Emitter Turn-On Voltage	$V_{BE(on)}$		1.7		1.7	V	$I_C=1\text{A}, V_{CE}=5\text{V}^*$

ZTX602 ZTX603

ELECTRICAL CHARACTERISTICS (at $T_{amb} = 25^{\circ}\text{C}$ unless otherwise stated).

PARAMETER	SYMBOL	ZTX602		ZTX603		UNIT	CONDITIONS.
		MIN.	MAX.	MIN.	MAX.		
Static Forward Current Transfer Ratio	h_{FE}	2K 5K 2K 0.5K	100K	2K 5K 2K 0.5K	100K		$I_C=50\text{mA}, V_{CE}=5\text{V}$ $I_C=500\text{mA}, V_{CE}=5\text{V}^*$ $I_C=1\text{A}, V_{CE}=5\text{V}^*$ $I_C=2\text{A}, V_{CE}=5\text{V}^*$
Transition Frequency	f_T	150		150		MHz	$I_C=100\text{mA}, V_{CE}=10\text{V}$ $f=20\text{MHz}$
Input Capacitance	C_{ibo}	90 Typical				pF	$V_{EB}=500\text{mV}, f=1\text{MHz}$
Output Capacitance	C_{obo}	15 Typical				pF	$V_{CB}=10\text{V}, f=1\text{MHz}$
Switching Times	t_{on}	0.5 Typical				μs	$I_C=500\text{mA}, V_{CE}=10\text{V}$ $I_{B1}=I_{B2}=0.5\text{mA}$
	t_{off}	1.1 Typical				μs	

*Measured under pulsed conditions. Pulse width=300 μs . Duty cycle $\leq 2\%$

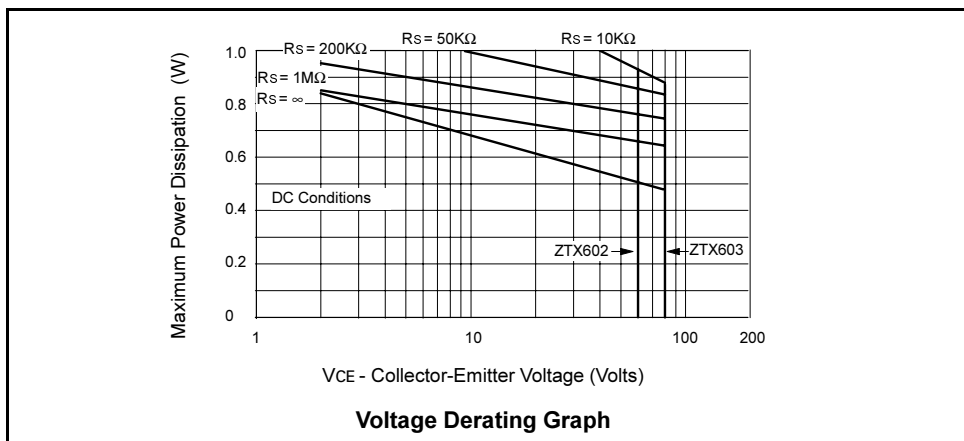

The maximum permissible operational temperature can be obtained from this graph using the following equation

$$T_{amb(max)} = \frac{\text{Power(max)} - \text{Power(act)}}{0.0057} + 25^{\circ}\text{C}$$

$T_{amb(max)}$ = Maximum operating ambient temperature

Power(max) = Maximum power dissipation figure, obtained from the above graph for a given V_{CE} and source resistance (R_S)

Power(actual) = Actual power dissipation in users circuit

ZTX602 ZTX603

TYPICAL CHARACTERISTICS

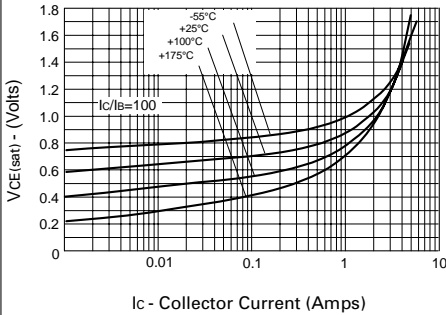

$V_{CE(sat)}$ v I_C

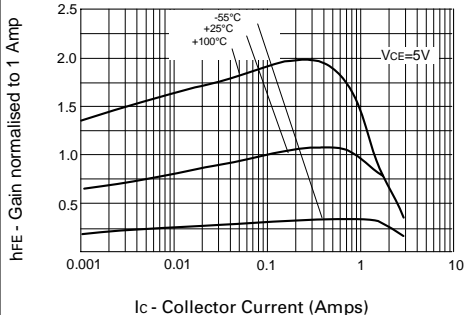

hFE v I_C

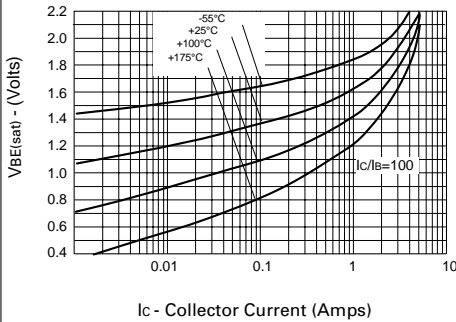

$V_{BE(sat)}$ v I_C

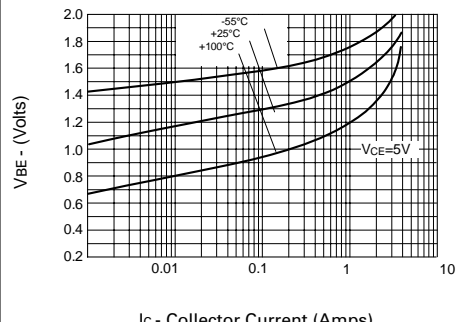

$V_{BE(on)}$ v I_C

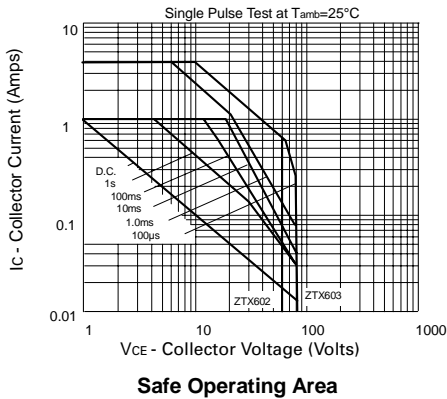

Mouser Electronics

Authorized Distributor

Click to View Pricing, Inventory, Delivery & Lifecycle Information:

[Diodes Inc.:](#)

[ZTX603STZ](#)

[Diodes Incorporated:](#)

[ZTX603](#)