

## Features

- Planar Die Construction
- 500mW Power Dissipation
- General Purpose, Medium Current
- Ideally Suited for Automated Assembly Processes
- **Totally Lead-Free & Fully RoHS Compliant (Notes 1 & 2)**
- **Halogen and Antimony Free. "Green" Device (Notes 3 & 4)**
- **Qualified to AEC-Q101 Standards for High Reliability**

## Mechanical Data

- Case: SOD123
- Case Material: Molded Plastic. UL Flammability Classification Rating 94V-0
- Moisture Sensitivity: Level 1 per J-STD-020
- Terminals: Matte Tin Finish annealed over Alloy 42 leadframe (Lead Free Plating). Solderable per MIL-STD-202, Method 208
- Polarity: Cathode Band
- Weight: 0.010 grams (approximate)

SOD123



Top View

## Ordering Information (Notes 5 & 6)

Part Number	Qualification	Case	Packaging
(Type Number)-7-F	Commercial	SOD123	3000/Tape & Reel
(Type Number)Q-7-F	Automotive	SOD123	3000/Tape & Reel
(Type Number)-13-F	Commercial	SOD123	10,000/Tape & Reel
(Type Number)Q-13-F	Automotive	SOD123	10,000/Tape & Reel

- Notes:
1. No purposely added lead. Fully EU Directive 2002/95/EC (RoHS) & 2011/65/EU (RoHS 2) compliant.
  2. See <http://www.diodes.com> for more information about Diodes Incorporated's definitions of Halogen- and Antimony-free, "Green" and Lead-free.
  3. Halogen- and Antimony-free "Green" products are defined as those which contain <900ppm bromine, <900ppm chlorine (<1500ppm total Br + Cl) and <1000ppm antimony compounds.
  4. Product manufactured with Date Code V9 (week 33, 2008) and newer are built with Green Molding Compound. Product manufactured prior to Date Code V9 are built with Non-Green Molding Compound and may contain Halogens or Sb<sub>2</sub>O<sub>3</sub> Fire Retardants.
  5. For packaging details, go to our website at <http://www.diodes.com>.
  6. For (Type Number), please see the Electrical Characteristics Table. Example: 6.2V Zener = BZT52C6V2Q-13-F.

## Marking Information



xx = Product Type Marking Code  
 (See Electrical Characteristics Table)  
 YM = Date Code Marking  
 Y = Year (ex: N = 2002)  
 M = Month (ex: 9 = September)

### Date Code Key

Year	2002	2003	2004	2005	2006	2007	2008	2009	2010	2011	2012	2013	2014	2015	2016	2017
Code	N	P	R	S	T	U	V	W	X	Y	Z	A	B	C	D	E

Month	Jan	Feb	Mar	Apr	May	Jun	Jul	Aug	Sep	Oct	Nov	Dec
Code	1	2	3	4	5	6	7	8	9	O	N	D

**Maximum Ratings** (@T<sub>A</sub> = +25°C, unless otherwise specified.)

Single phase, half wave, 60Hz, resistive or inductive load.  
For capacitance load, derate current by 20%.

Characteristic	Symbol	Value	Unit
Forward Voltage @ I <sub>F</sub> = 10mA	V <sub>F</sub>	0.9	V

**Thermal Characteristics**

Characteristic	Symbol	Value	Unit
Power Dissipation (Note 7) @T <sub>L</sub> = +75°C	P <sub>D</sub>	500	mW
Power Dissipation (Note 8) @T <sub>A</sub> = +25°C	P <sub>D</sub>	370	mW
Thermal Resistance, Junction to Ambient Air (Note 8)	R <sub>θJA</sub>	338	°C/W
Thermal Resistance, Junction to Lead (Note 9)	R <sub>θJL</sub>	150	°C/W
Operating and Storage Temperature Range	T <sub>J</sub> , T <sub>STG</sub>	-65 to +150	°C

**Electrical Characteristics** (@T<sub>A</sub> = +25°C, unless otherwise specified.)

Type Number	Marking Codes	Zener Voltage Range (Note 10)				Maximum Zener Impedance f = 1kHz			Maximum Reverse Current (Note 10)		Temperature Coefficient @ I <sub>ZTC</sub> mV/°C		Test Current I <sub>ZTC</sub> mA
		V <sub>Z</sub> @ I <sub>ZT</sub>			I <sub>ZT</sub> mA	Z <sub>VT</sub> @ I <sub>ZT</sub> Ω	Z <sub>ZK</sub> @ I <sub>ZK</sub> Ω	I <sub>ZK</sub> mA	I <sub>R</sub> uA	@ V <sub>R</sub> V	Min	Max	
		Nom (V)	Min (V)	Max (V)									
BZT52C2V0	WY	2.0	1.91	2.09	5	100	600	1.0	150	1.0	-3.5	0	5
BZT52C2V4	WX	2.4	2.2	2.6	5	100	600	1.0	50	1.0	-3.5	0	5
BZT52C2V7	W1	2.7	2.5	2.9	5	100	600	1.0	20	1.0	-3.5	0	5
BZT52C3V0	W2	3.0	2.8	3.2	5	95	600	1.0	10	1.0	-3.5	0	5
BZT52C3V3	W3	3.3	3.1	3.5	5	95	600	1.0	5.0	1.0	-3.5	0	5
BZT52C3V6	W4	3.6	3.4	3.8	5	90	600	1.0	5.0	1.0	-3.5	0	5
BZT52C3V9	W5	3.9	3.7	4.1	5	90	600	1.0	3.0	1.0	-3.5	0	5
BZT52C4V3	W6	4.3	4.0	4.6	5	90	600	1.0	3.0	1.0	-3.5	0	5
BZT52C4V7	W7	4.7	4.4	5.0	5	80	500	1.0	3.0	2.0	-3.5	0.2	5
BZT52C5V1	W8	5.1	4.8	5.4	5	60	480	1.0	2.0	2.0	-2.7	1.2	5
BZT52C5V6	W9	5.6	5.2	6.0	5	40	400	1.0	1.0	2.0	-2	2.5	5
BZT52C6V2	WA	6.2	5.8	6.6	5	10	150	1.0	3.0	4.0	0.4	3.7	5
BZT52C6V8	WB	6.8	6.4	7.2	5	15	80	1.0	2.0	4.0	1.2	4.5	5
BZT52C7V5	WC	7.5	7.0	7.9	5	15	80	1.0	1.0	5.0	2.5	5.3	5
BZT52C8V2	WD	8.2	7.7	8.7	5	15	80	1.0	0.7	5.0	3.2	6.2	5
BZT52C9V1	WE	9.1	8.5	9.6	5	15	100	1.0	0.5	6.0	3.8	7.0	5
BZT52C10	WF	10	9.4	10.6	5	20	150	1.0	0.2	7.0	4.5	8.0	5
BZT52C11	WG	11	10.4	11.6	5	20	150	1.0	0.1	8.0	5.4	9.0	5
BZT52C12	WH	12	11.4	12.7	5	25	150	1.0	0.1	8.0	6.0	10.0	5
BZT52C13	WI	13	12.4	14.1	5	30	170	1.0	0.1	8.0	7.0	11.0	5
BZT52C15	WJ	15	13.8	15.6	5	30	200	1.0	0.1	10.5	9.2	13.0	5
BZT52C16	WK	16	15.3	17.1	5	40	200	1.0	0.1	11.2	10.4	14.0	5
BZT52C18	WL	18	16.8	19.1	5	45	225	1.0	0.1	12.6	12.4	16.0	5
BZT52C20	WM	20	18.8	21.2	5	55	225	1.0	0.1	14.0	14.4	18.0	5
BZT52C22	WN	22	20.8	23.3	5	55	250	1.0	0.1	15.4	16.4	-	5
BZT52C24	WO	24	22.8	25.6	5	70	250	1.0	0.1	16.8	18.4	-	5
BZT52C27	WP	27	25.1	28.9	2	80	300	0.5	0.1	18.9	21.4	-	2
BZT52C30	WQ	30	28.0	32.0	2	80	300	0.5	0.1	21.0	24.4	-	2
BZT52C33	WR	33	31.0	35.0	2	80	325	0.5	0.1	23.1	27.4	-	2
BZT52C36	WS	36	34.0	38.0	2	90	350	0.5	0.1	25.2	30.4	-	2
BZT52C39	WT	39	37.0	41.0	2	130	350	0.5	0.1	27.3	33.4	-	2
BZT52C43	WU	43	40.0	46.0	5	100	700	1.0	0.1	32.0	37.6	-	5
BZT52C47	WV	47	44.0	50.0	5	100	750	1.0	0.1	35.0	42.0	-	5
BZT52C51	WW	51	48.0	54.0	5	100	750	1.0	0.1	38.0	46.6	-	5

- Notes: 7. R<sub>θJL</sub> = 132°C/W  
8. Device mounted on ceramic PCB with copper pad areas 40mm<sup>2</sup>.  
9. Thermal Resistance measurement obtained via infrared scan method.  
10. Short duration pulse test used to minimize self-heating effect.

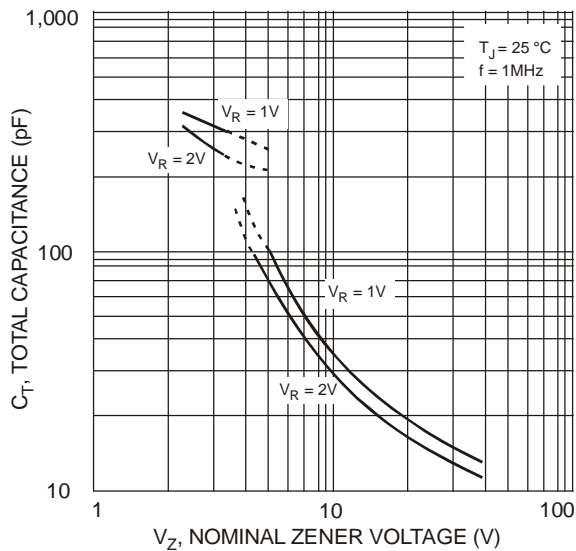
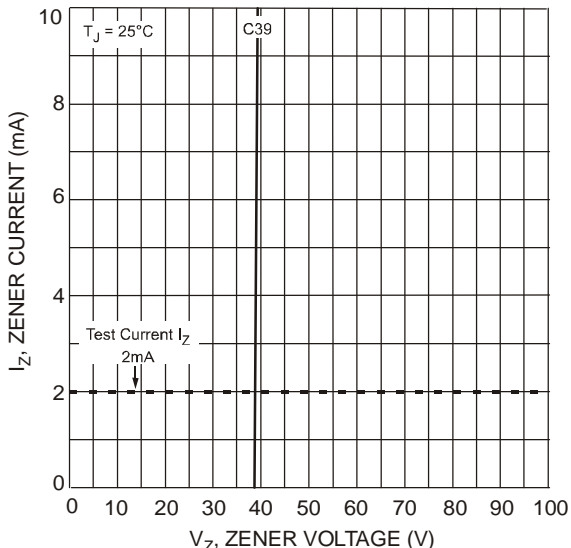
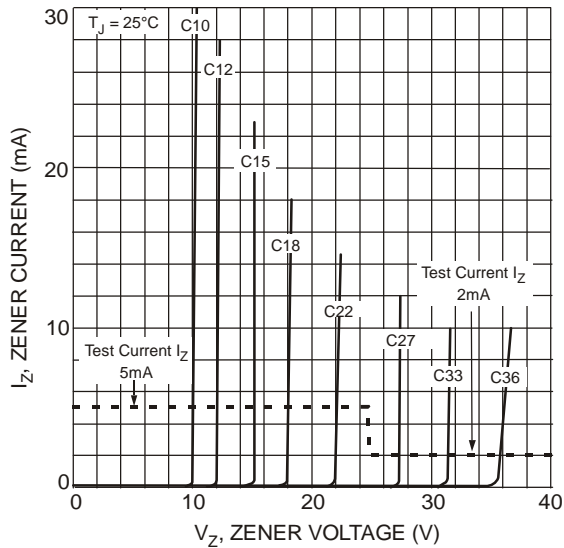
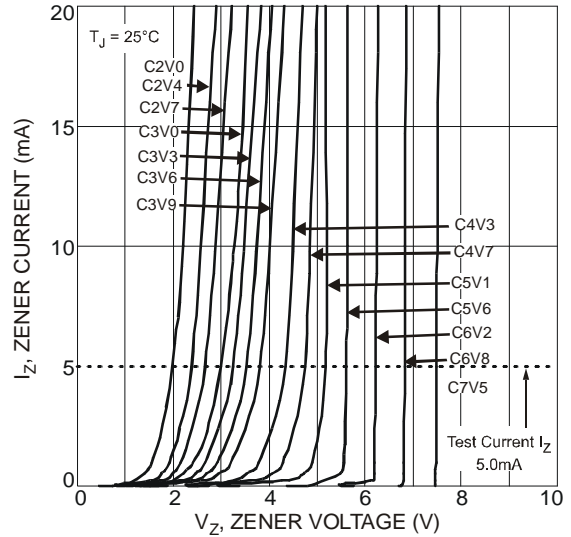
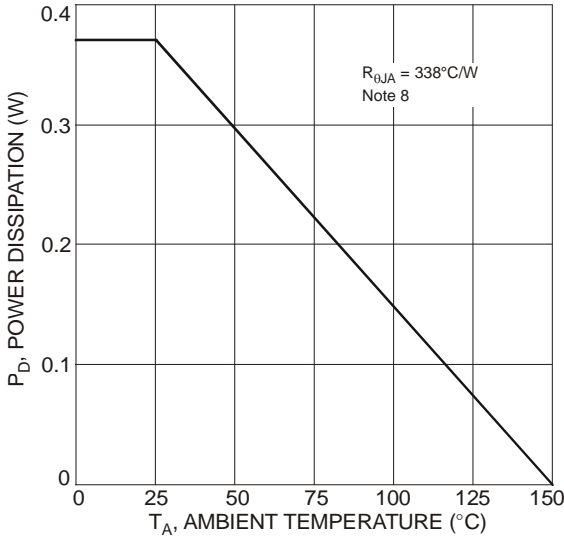

**Package Outline Dimensions**

Please see AP02002 at <http://www.diodes.com/datasheets/ap02002.pdf> for latest version.

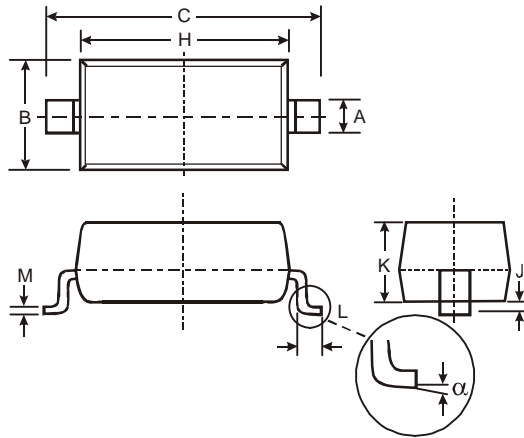

SOD123		
Dim	Min	Max
A	0.55 Typ	
B	1.40	1.70
C	3.55	3.85
H	2.55	2.85
J	0.00	0.10
K	1.00	1.35
L	0.25	0.40
M	0.10	0.15
α	0	8°
All Dimensions in mm		

**Suggested Pad Layout**

Please see AP02001 at <http://www.diodes.com/datasheets/ap02001.pdf> for the latest version.

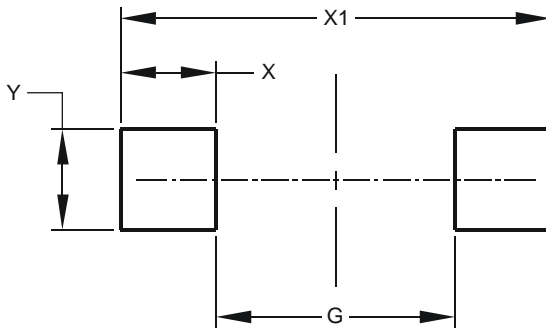

Dimensions	Value (in mm)
G	2.250
X	0.900
X1	4.050
Y	0.950

#### **IMPORTANT NOTICE**

DIODES INCORPORATED MAKES NO WARRANTY OF ANY KIND, EXPRESS OR IMPLIED, WITH REGARDS TO THIS DOCUMENT, INCLUDING, BUT NOT LIMITED TO, THE IMPLIED WARRANTIES OF MERCHANTABILITY AND FITNESS FOR A PARTICULAR PURPOSE (AND THEIR EQUIVALENTS UNDER THE LAWS OF ANY JURISDICTION).

Diodes Incorporated and its subsidiaries reserve the right to make modifications, enhancements, improvements, corrections or other changes without further notice to this document and any product described herein. Diodes Incorporated does not assume any liability arising out of the application or use of this document or any product described herein; neither does Diodes Incorporated convey any license under its patent or trademark rights, nor the rights of others. Any Customer or user of this document or products described herein in such applications shall assume all risks of such use and will agree to hold Diodes Incorporated and all the companies whose products are represented on Diodes Incorporated website, harmless against all damages.

Diodes Incorporated does not warrant or accept any liability whatsoever in respect of any products purchased through unauthorized sales channel. Should Customers purchase or use Diodes Incorporated products for any unintended or unauthorized application, Customers shall indemnify and hold Diodes Incorporated and its representatives harmless against all claims, damages, expenses, and attorney fees arising out of, directly or indirectly, any claim of personal injury or death associated with such unintended or unauthorized application.

Products described herein may be covered by one or more United States, international or foreign patents pending. Product names and markings noted herein may also be covered by one or more United States, international or foreign trademarks.

#### **LIFE SUPPORT**

Diodes Incorporated products are specifically not authorized for use as critical components in life support devices or systems without the express written approval of the Chief Executive Officer of Diodes Incorporated. As used herein:

A. Life support devices or systems are devices or systems which:

1. are intended to implant into the body, or
2. support or sustain life and whose failure to perform when properly used in accordance with instructions for use provided in the labeling can be reasonably expected to result in significant injury to the user.

B. A critical component is any component in a life support device or system whose failure to perform can be reasonably expected to cause the failure of the life support device or to affect its safety or effectiveness.

Customers represent that they have all necessary expertise in the safety and regulatory ramifications of their life support devices or systems, and acknowledge and agree that they are solely responsible for all legal, regulatory and safety-related requirements concerning their products and any use of Diodes Incorporated products in such safety-critical, life support devices or systems, notwithstanding any devices- or systems-related information or support that may be provided by Diodes Incorporated. Further, Customers must fully indemnify Diodes Incorporated and its representatives against any damages arising out of the use of Diodes Incorporated products in such safety-critical, life support devices or systems.

Copyright © 2012, Diodes Incorporated

[www.diodes.com](http://www.diodes.com)

# Mouser Electronics

Authorized Distributor

Click to View Pricing, Inventory, Delivery & Lifecycle Information:

## Diodes Inc.:

[BZT52C3V9-7-F](#) [BZT52C16-7-F](#) [BZT52C12-7-F](#) [BZT52C5V1-7-F](#) [BZT52C8V2-7-F](#) [BZT52C5V6-7-F](#) [BZT52C3V6-7-F](#) [BZT52C6V8-7-F](#) [BZT52C15-7-F](#) [BZT52C6V2-7-F](#) [BZT52C11-7-F](#) [BZT52C3V0-7-F](#) [BZT52C3V3-7-F](#) [BZT52C18-7-F](#) [BZT52C10-7-F](#) [BZT52C4V3-7-F](#) [BZT52C7V5-7-F](#) [BZT52C4V7-7-F](#) [BZT52C33-7-F](#) [BZT52C27-7-F](#) [BZT52C2V7-7-F](#) [BZT52C20-7-F](#) [BZT52C2V4-7-F](#) [BZT52C9V1-7-F](#) [BZT52C24-7-F](#) [BZT52C16-13-F](#) [BZT52C24-13-F](#) [BZT52C2V4-13-F](#) [BZT52C33-13-F](#) [BZT52C6V2-13-F](#) [BZT52C13-7-F](#) [BZT52C22-7-F](#) [BZT52C2V0-7-F](#) [BZT52C30-7-F](#) [BZT52C36-7-F](#) [BZT52C39-7-F](#) [BZT52C27-13-F](#) [BZT52C39-13-F](#)

## Diodes Incorporated:

[BZT52C3V6-13-F](#) [BZT52C15-13-F](#) [BZT52C20-13-F](#) [BZT52C22-13-F](#) [BZT52C2V7-13-F](#) [BZT52C5V1-13-F](#) [BZT52C6V8-13-F](#) [BZT52C8V2-13-F](#) [BZT52C9V1-13-F](#) [BZT52C43-7-F](#) [BZT52C47-7-F](#) [BZT52C51-7-F](#) [BZT52C12-13-F](#) [BZT52C5V6-13-F](#) [BZT52C4V7-13-F](#)