

**COMMON SOURCE DUAL N-CHANNEL  
ENHANCEMENT MODE FIELD EFFECT TRANSISTOR**

NEW PRODUCT

**Features**

- Common Source Dual N-Channel MOSFET
- Low On-Resistance
- Very Low Gate Threshold Voltage, 1.2V max
- Low Input Capacitance
- Fast Switching Speed
- Low Input/Output Leakage
- Small Surface Mount Package
- ESD Protected Gate
- **Lead Free By Design/RoHS Compliant (Note 2)**
- **"Green" Device (Note 3)**
- **Qualified to AEC-Q 101 Standards for High Reliability**

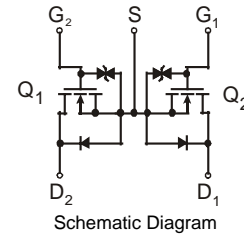
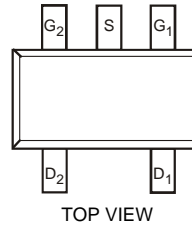

SOT-353

**Mechanical Data**

- Case: SOT-353
- Case Material: Molded Plastic, "Green" Molding Compound. UL Flammability Classification Rating 94V-0
- Moisture Sensitivity: Level 1 per J-STD-020C
- Terminal Connections: See Diagram
- Terminals: Finish – Matte Tin annealed over Alloy 42 leadframe. Solderable per MIL-STD-202, Method 208
- Marking Information: See Page 3
- Ordering Information: See Page 3
- Weight: 0.006 grams (approximate)

**Maximum Ratings**  $Q_1, Q_2$  @  $T_A = 25^\circ\text{C}$  unless otherwise specified

Characteristic	Symbol	Value	Unit
Drain Source Voltage	$V_{DSS}$	30	V
Gate-Source Voltage	$V_{GSS}$	$\pm 10$	V
Drain Current (Note 1)	$I_D$	400	mA

**Thermal Characteristics**  $Q_1, Q_2$  @  $T_A = 25^\circ\text{C}$  unless otherwise specified

Total Power Dissipation (Note 1)	$P_D$	280	mW
Thermal Resistance, Junction to Ambient (Note 1)	$R_{\theta JA}$	446	$^\circ\text{C/W}$
Operating and Storage Temperature Range	$T_j, T_{STG}$	-55 to +150	$^\circ\text{C}$

**Electrical Characteristics**  $Q_1, Q_2$  @  $T_A = 25^\circ\text{C}$  unless otherwise specified

Characteristic	Symbol	Min	Typ	Max	Unit	Test Condition
<b>OFF CHARACTERISTICS (Note 4)</b>						
Drain-Source Breakdown Voltage	$BV_{DSS}$	30	—	—	V	$V_{GS} = 0V, I_D = 250\mu\text{A}$
Zero Gate Voltage Drain Current	$I_{DSS}$	—	—	1	$\mu\text{A}$	@ $T_C = 25^\circ\text{C}$ $V_{DS} = 30V, V_{GS} = 0V$
Gate-Body Leakage	$I_{GSS}$	—	—	$\pm 10$ $\pm 1$	$\mu\text{A}$	$V_{GS} = \pm 10V, V_{DS} = 0V$ $V_{GS} = \pm 5V, V_{DS} = 0V$
<b>ON CHARACTERISTICS (Note 4)</b>						
Gate Threshold Voltage	$V_{GS(th)}$	0.6	—	1.2	V	$V_{DS} = V_{GS}, I_D = 250\mu\text{A}$
Static Drain-Source On-Resistance	$R_{DS(on)}$	—	—	2.2 1.5 1.2	$\Omega$	$V_{GS} = 1.8V, I_D = 20\text{mA}$ $V_{GS} = 2.5V, I_D = 20\text{mA}$ $V_{GS} = 4.0V, I_D = 100\text{mA}$
Forward Transconductance	$ Y_{fs} $	100	—	—	mS	$V_{DS} = 10V, I_D = 0.1A$
Source-Drain Diode Forward Voltage	$V_{SD}$	0.5	—	1.4	V	$V_{GS} = 0V, I_S = 115\text{mA}$
<b>DYNAMIC CHARACTERISTICS</b>						
Input Capacitance	$C_{iss}$	—	39	—	pF	$V_{DS} = 3V, V_{GS} = 0V$ $f = 1.0\text{MHz}$
Output Capacitance	$C_{oss}$	—	10	—	pF	
Reverse Transfer Capacitance	$C_{rss}$	—	3.6	—	pF	
Switching Time	Turn-on Time	$t_{on}$	—	11	nS	$V_{DD} = 5V, I_D = 10\text{mA},$ $V_{GS} = 0-5V$
	Turn-off Time	$t_{off}$	—	51	nS	

- Notes:
1. Device mounted on FR-4 PCB, 1 inch x 0.85 inch x 0.062 inch; pad layout as shown on Diodes Inc. suggested pad layout document AP02001, which can be found on our website at <http://www.diodes.com/datasheets/ap02001.pdf>.
  2. No purposefully added lead.
  3. Diodes Inc.'s "Green" policy can be found on our website at [http://www.diodes.com/products/lead\\_free/index.php](http://www.diodes.com/products/lead_free/index.php).
  4. Short duration pulse test used to minimize self-heating effect.

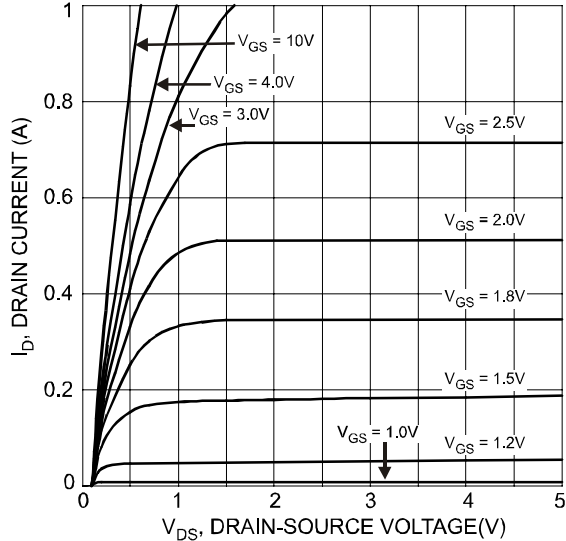

Fig. 1 Typical Output Characteristics

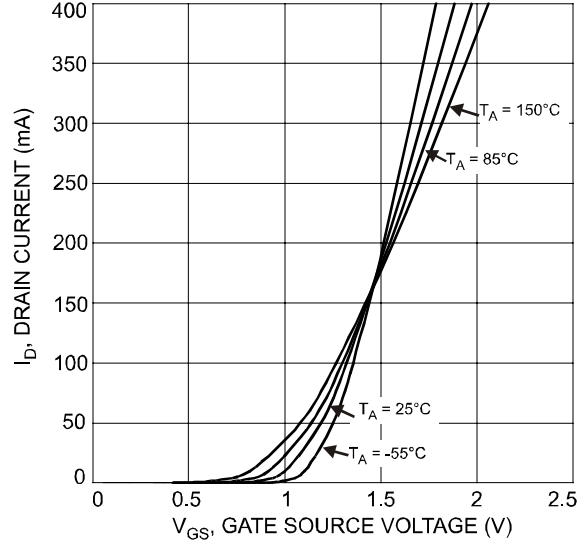

Fig. 2 Typical Transfer Characteristics

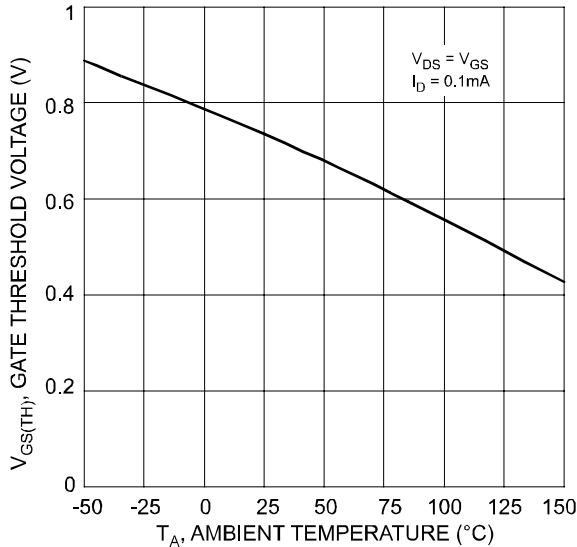

Fig. 3 Gate Threshold Voltage vs. Ambient Temperature

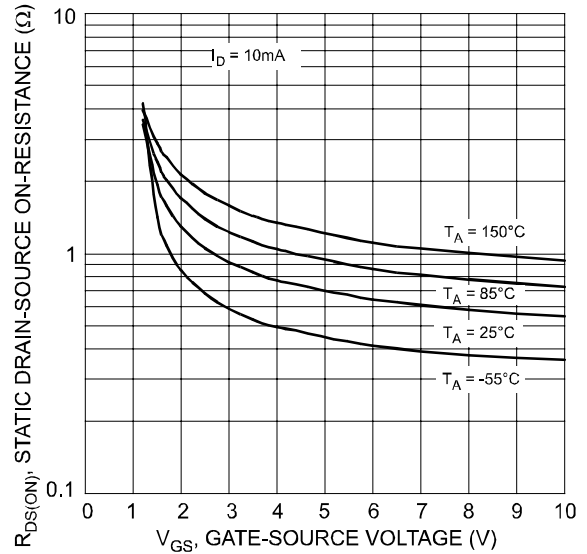

Fig. 4 Static Drain-Source On-Resistance vs. Gate-Source Voltage

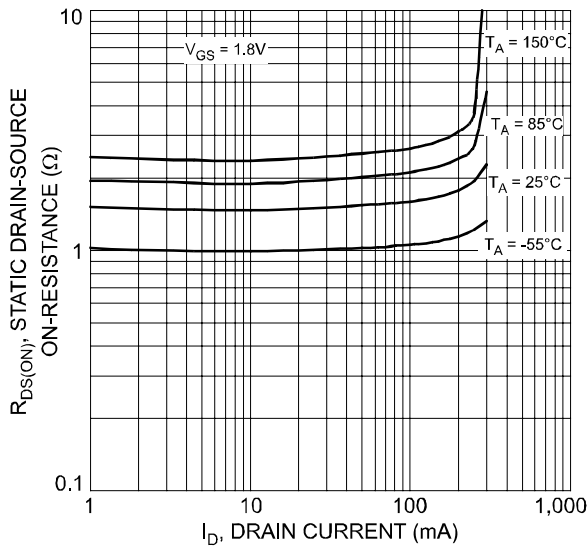

Fig. 5 Static Drain-Source On-Resistance vs. Drain Current

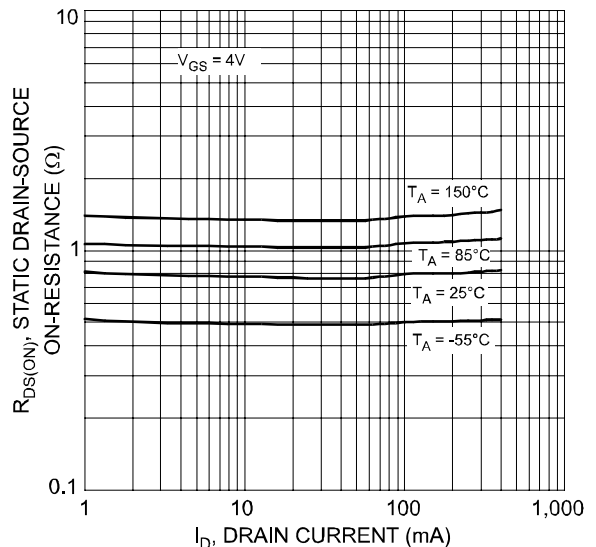

Fig. 6 Static Drain-Source On-Resistance vs. Drain Current

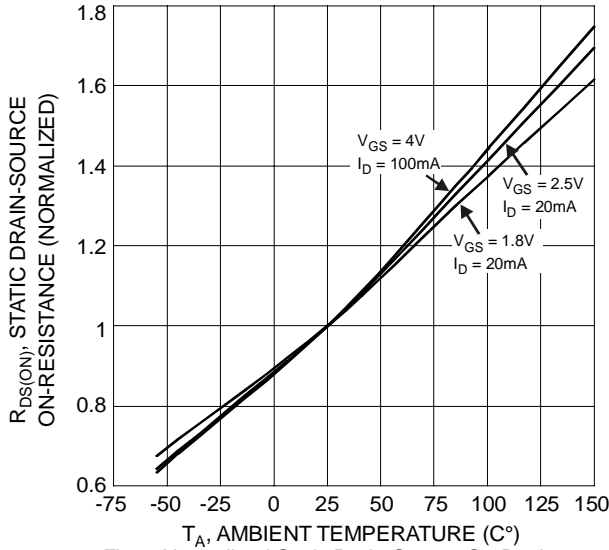

Fig. 7 Normalized Static Drain-Source On-Resistance vs. Ambient Temperature

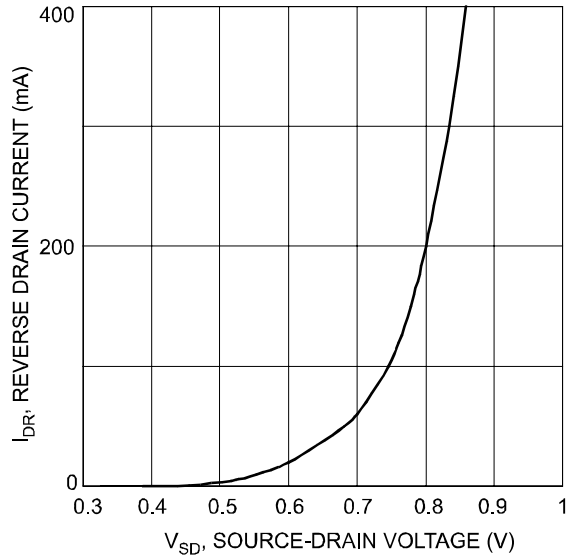

Fig. 8 Reverse Drain Current vs. Source-Drain Voltage

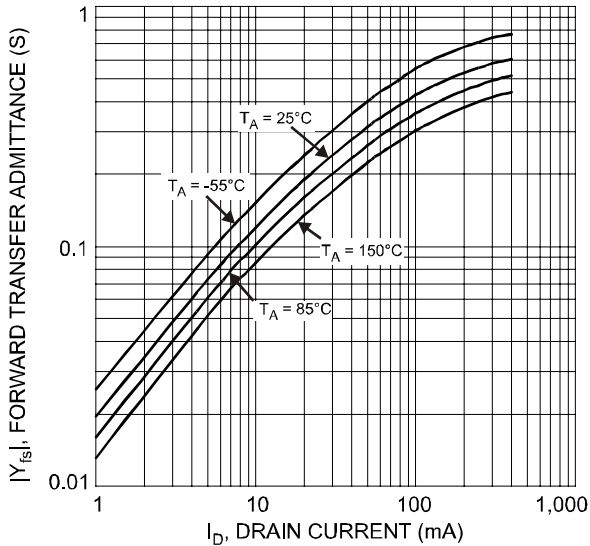

Fig. 9 Forward Transfer Admittance vs. Drain Current

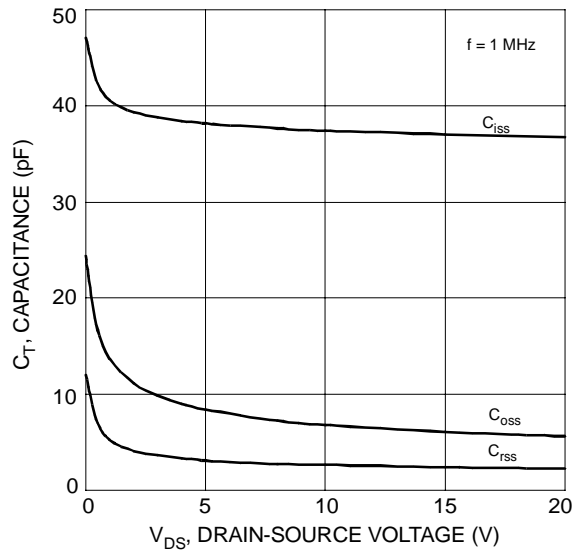

Fig. 10 Typical Capacitance

**Ordering Information** (Note 5)

Part Number	Case	Packaging
DMN32D2LDF-7	SOT-353	3000/Tape & Reel

Notes: 5. For packaging details, go to our website at <http://www.diodes.com/datasheets/ap02007.pdf>.

**Marking Information** (Note 6)

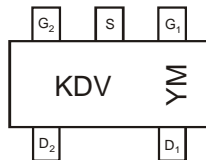

KDV = Product Type Marking Code (See Note 6)  
 YM = Date Code Marking  
 Y = Year ex: U = 2007  
 M = Month ex: 9 = September

Notes: 6. Package is non-polarized. Parts may be on reel in orientation illustrated, 180° rotated, or mixed (both ways).

**Date Code Key**

Year	2007	2008	2009	2010	2011	2012
Code	U	V	W	X	Y	Z

Month	Jan	Feb	Mar	Apr	May	Jun	Jul	Aug	Sep	Oct	Nov	Dec
Code	1	2	3	4	5	6	7	8	9	O	N	D

**Package Outline Dimensions**

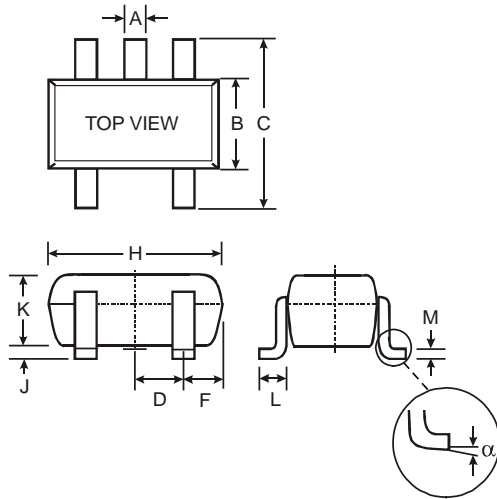

SOT-353		
Dim	Min	Max
A	0.10	0.30
B	1.15	1.35
C	2.00	2.20
D	0.65 Nominal	
F	0.30	0.40
H	1.80	2.20
J	—	0.10
K	0.90	1.00
L	0.25	0.40
M	0.10	0.25
α	0°	8°
All Dimensions in mm		

**Suggested Pad Layout**

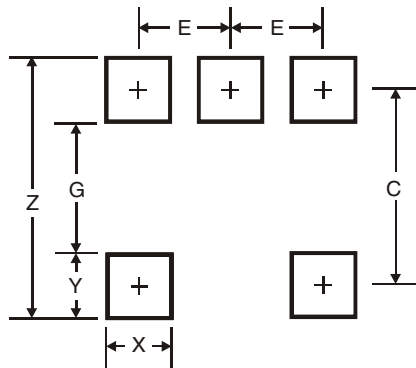

Dimensions	Value (in mm)
Z	2.5
G	1.3
X	0.42
Y	0.6
C	1.9
E	0.65

**IMPORTANT NOTICE**

Diodes Incorporated and its subsidiaries reserve the right to make modifications, enhancements, improvements, corrections or other changes without further notice to any product herein. Diodes Incorporated does not assume any liability arising out of the application or use of any product described herein; neither does it convey any license under its patent rights, nor the rights of others. The user of products in such applications shall assume all risks of such use and will agree to hold Diodes Incorporated and all the companies whose products are represented on our website, harmless against all damages.

**LIFE SUPPORT**

Diodes Incorporated products are not authorized for use as critical components in life support devices or systems without the expressed written approval of the President of Diodes Incorporated.

# Mouser Electronics

Authorized Distributor

Click to View Pricing, Inventory, Delivery & Lifecycle Information:

[Diodes Incorporated:](#)

[DMN32D2LDF-7](#)