



FCH170N60

N-Channel SuperFET[®] II MOSFET

600 V, 22 A, 170 mΩ

Features

- 650 V @T_J = 150°C
- Typ. R_{DS(on)} = 150 mΩ
- Ultra Low Gate Charge (Typ. Q_g = 42 nC)
- Low Effective Output Capacitance (Typ. C_{oss(eff.)} = 190 pF)
- 100% Avalanche Tested
- RoHS Compliant

Description

SuperFET[®] II MOSFET is Fairchild Semiconductor's brand-new high voltage super-junction (SJ) MOSFET family that is utilizing charge balance technology for outstanding low on-resistance and lower gate charge performance. This advanced technology is tailored to minimize conduction loss, provide superior switching performance, and withstand extreme dv/dt rate and higher avalanche energy. Consequently, SuperFET II MOSFET is suitable for various AC/DC power conversion for system miniaturization and higher efficiency.

Applications

- Telecom / Server Power Supplies
- Industrial Power Supplies
- AC-DC Power Supply

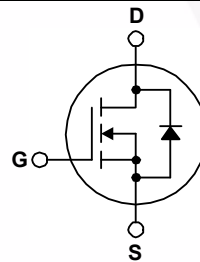
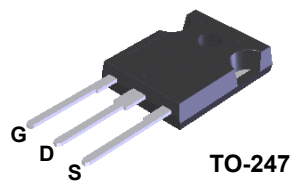

Absolute Maximum Ratings T_C = 25°C unless otherwise noted.

Symbol	Parameter	FCH170N60	Unit
V _{DSS}	Drain to Source Voltage	600	V
V _{GSS}	Gate to Source Voltage	- DC	±20
		- AC	±30
I _D	Drain Current	- Continuous (T _C = 25°C)	22
		- Continuous (T _C = 100°C)	14
I _{DM}	Drain Current	- Pulsed (Note 1)	66
E _{AS}	Single Pulsed Avalanche Energy	(Note 2)	525
I _{AR}	Avalanche Current	(Note 1)	5
E _{AR}	Repetitive Avalanche Energy	(Note 1)	2.27
dv/dt	MOSFET dv/dt	(Note 3)	100
	Peak Diode Recovery dv/dt		20
P _D	Power Dissipation	(T _C = 25°C)	227
		- Derate above 25°C	1.82
T _J , T _{STG}	Operating and Storage Temperature Range	-55 to +150	°C
T _L	Maximum Lead Temperature for Soldering, 1/8" from Case for 5 Seconds	300	°C

Thermal Characteristics

Symbol	Parameter	FCH170N60	Unit
R _{θJC}	Thermal Resistance, Junction to Case, Max.	0.55	°C/W
R _{θJA}	Thermal Resistance, Junction to Ambient, Max.	40	

Package Marking and Ordering Information

Device Marking	Device	Package	Reel Size	Tape Width	Quantity
FCH170N60	FCH170N60	TO-247	-	-	30

Electrical Characteristics $T_C = 25^\circ\text{C}$ unless otherwise noted.

Symbol	Parameter	Test Conditions	Min.	Typ.	Max.	Unit
--------	-----------	-----------------	------	------	------	------

Off Characteristics

BV_{DSS}	Drain to Source Breakdown Voltage	$I_D = 10\text{ mA}, V_{GS} = 0\text{ V}, T_J = 25^\circ\text{C}$	600	-	-	V
		$I_D = 10\text{ mA}, V_{GS} = 0\text{ V}, T_J = 150^\circ\text{C}$	650	-	-	V
$\Delta BV_{DSS} / \Delta T_J$	Breakdown Voltage Temperature Coefficient	$I_D = 10\text{ mA}$, Referenced to 25°C	-	0.67	-	$\text{V}/^\circ\text{C}$
I_{DSS}	Zero Gate Voltage Drain Current	$V_{DS} = 600\text{ V}, V_{GS} = 0\text{ V}$	-	-	1	μA
		$V_{DS} = 480\text{ V}, V_{GS} = 0\text{ V}, T_C = 125^\circ\text{C}$	-	1.2	-	
I_{GSS}	Gate to Body Leakage Current	$V_{GS} = \pm 20\text{ V}, V_{DS} = 0\text{ V}$	-	-	± 100	nA

On Characteristics

$V_{GS(th)}$	Gate Threshold Voltage	$V_{GS} = V_{DS}, I_D = 250\text{ }\mu\text{A}$	2.5	-	3.5	V
$R_{DS(on)}$	Static Drain to Source On Resistance	$V_{GS} = 10\text{ V}, I_D = 11\text{ A}$	-	150	170	$\text{m}\Omega$
g_{FS}	Forward Transconductance	$V_{DS} = 20\text{ V}, I_D = 11\text{ A}$	-	17	-	S

Dynamic Characteristics

C_{iss}	Input Capacitance	$V_{DS} = 380\text{ V}, V_{GS} = 0\text{ V}$ $f = 1\text{ MHz}$	-	2150	2860	pF
C_{oss}	Output Capacitance		-	60	80	pF
C_{rss}	Reverse Transfer Capacitance		-	2.65	-	pF
$C_{oss(eff.)}$	Effective Output Capacitance	$V_{DS} = 0\text{ V to } 480\text{ V}, V_{GS} = 0\text{ V}$	-	190	-	pF
$Q_{g(tot)}$	Total Gate Charge at 10V	$V_{DS} = 380\text{ V}, I_D = 11\text{ A},$ $V_{GS} = 10\text{ V}$ (Note 4)	-	42	55	nC
Q_{gs}	Gate to Source Gate Charge		-	9	-	nC
Q_{gd}	Gate to Drain "Miller" Charge		-	11	-	nC
ESR	Equivalent Series Resistance		$f = 1\text{ MHz}$	-	0.95	-

Switching Characteristics

$t_{d(on)}$	Turn-On Delay Time	$V_{DD} = 380\text{ V}, I_D = 11\text{ A},$ $V_{GS} = 10\text{ V}, R_g = 4.7\text{ }\Omega$ (Note 4)	-	21	50	ns
t_r	Turn-On Rise Time		-	12	35	ns
$t_{d(off)}$	Turn-Off Delay Time		-	55	120	ns
t_f	Turn-Off Fall Time		-	3.8	18	ns

Drain-Source Diode Characteristics

I_S	Maximum Continuous Drain to Source Diode Forward Current	-	-	22	A	
I_{SM}	Maximum Pulsed Drain to Source Diode Forward Current	-	-	66	A	
V_{SD}	Drain to Source Diode Forward Voltage	$V_{GS} = 0\text{ V}, I_{SD} = 11\text{ A}$	-	-	1.2	V
t_{rr}	Reverse Recovery Time	$V_{GS} = 0\text{ V}, I_{SD} = 11\text{ A},$ $di_F/dt = 100\text{ A}/\mu\text{s}$	-	346	-	ns
Q_{rr}	Reverse Recovery Charge		-	6.2	-	μC

Notes:

1. Repetitive rating: pulse width limited by maximum junction temperature
2. $I_{AS} = 5\text{ A}, R_G = 25\text{ }\Omega$, Starting $T_J = 25^\circ\text{C}$
3. $I_{SD} \leq 11\text{ A}, di/dt \leq 200\text{ A}/\mu\text{s}, V_{DD} \leq 380\text{ V}$, Starting $T_J = 25^\circ\text{C}$
4. Essentially independent of operating temperature typical characteristics

Typical Performance Characteristics

Figure 1. On-Region Characteristics

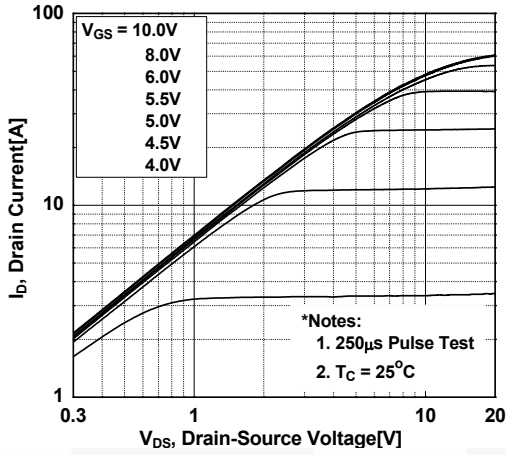

Figure 2. Transfer Characteristics

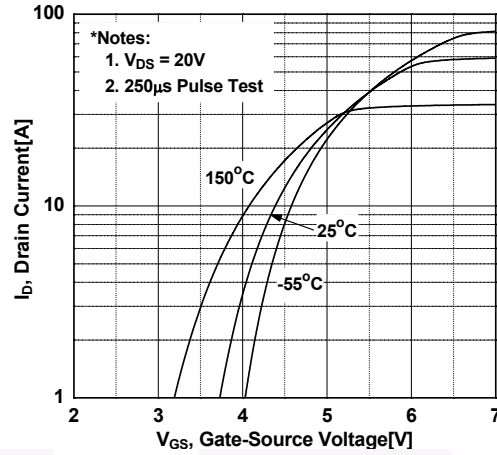

Figure 3. On-Resistance Variation vs. Drain Current and Gate Voltage

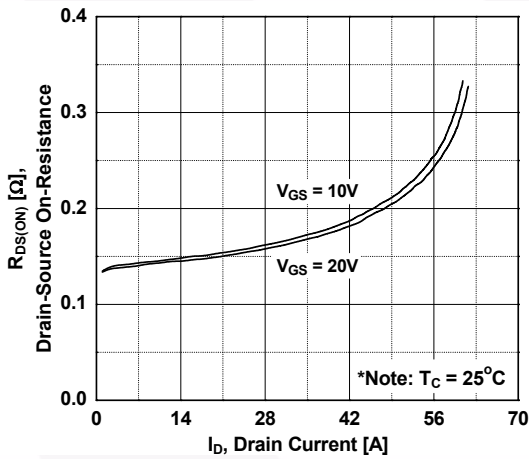

Figure 4. Body Diode Forward Voltage Variation vs. Source Current and Temperature

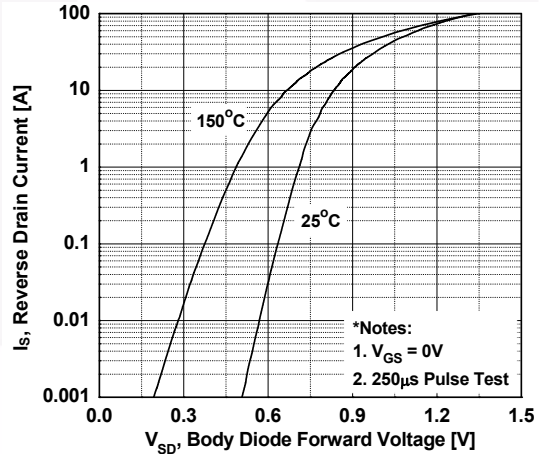

Figure 5. Capacitance Characteristics

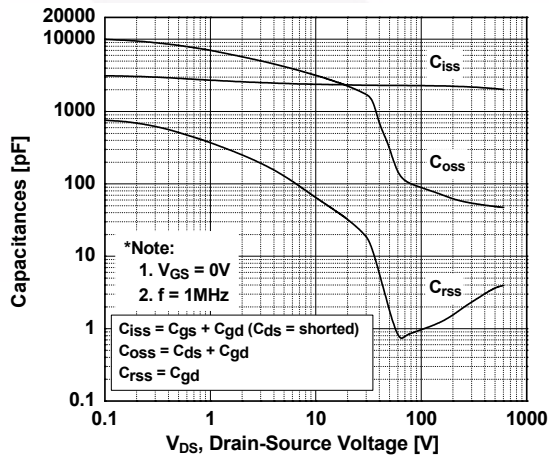
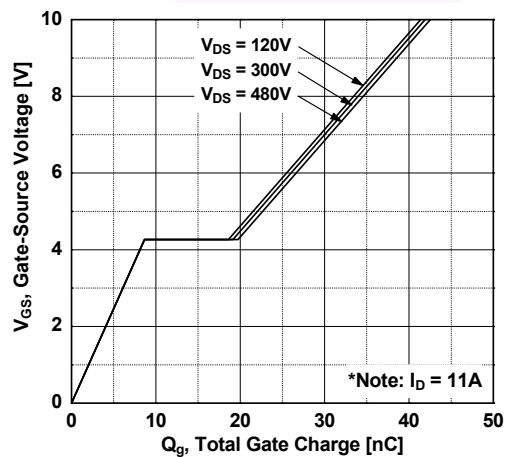

Figure 6. Gate Charge Characteristics



Typical Performance Characteristics (Continued)

Figure 7. Breakdown Voltage Variation vs. Temperature

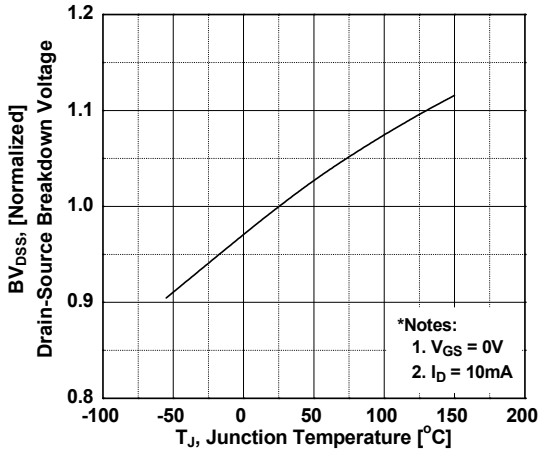

Figure 8. On-Resistance Variation vs. Temperature

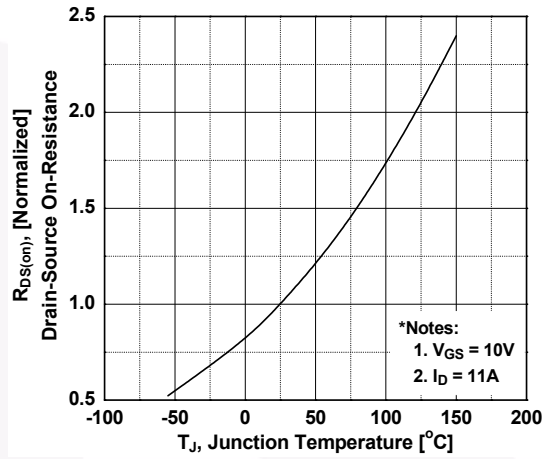

Figure 9. Maximum Safe Operating Area

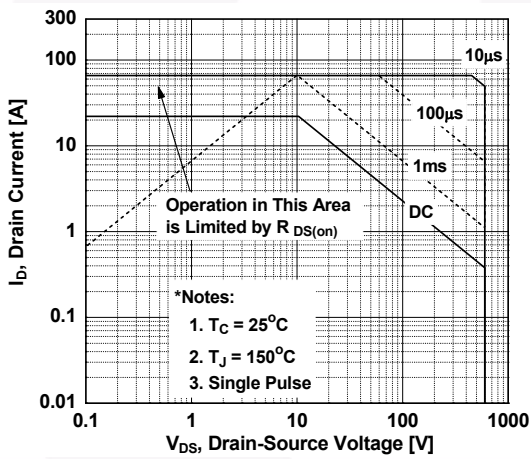

Figure 10. Maximum Drain Current vs. Case Temperature

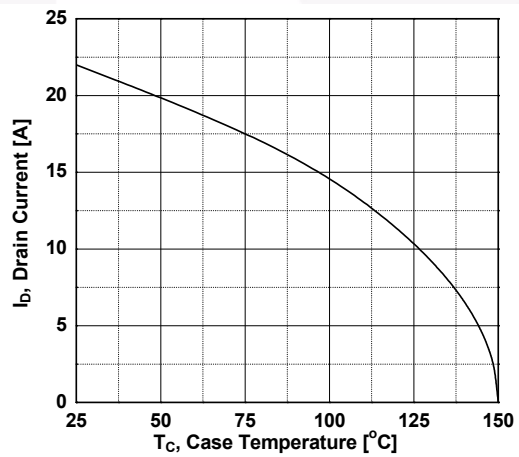
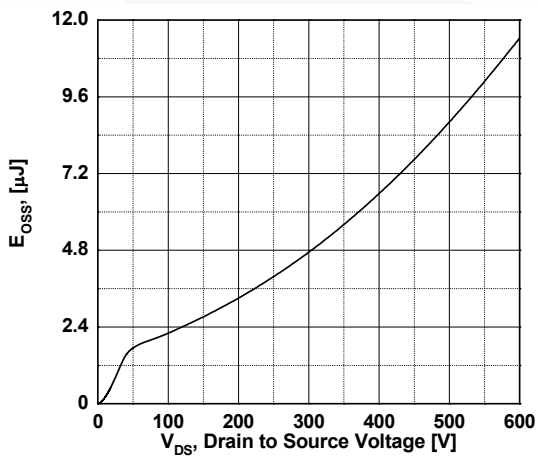
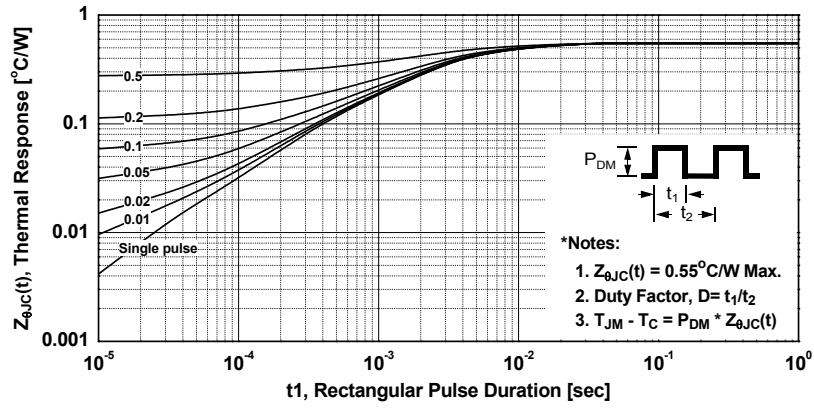

Figure 11. E_oss vs. Drain to Source Voltage



Typical Performance Characteristics (Continued)

Figure 12. Transient Thermal Response Curve



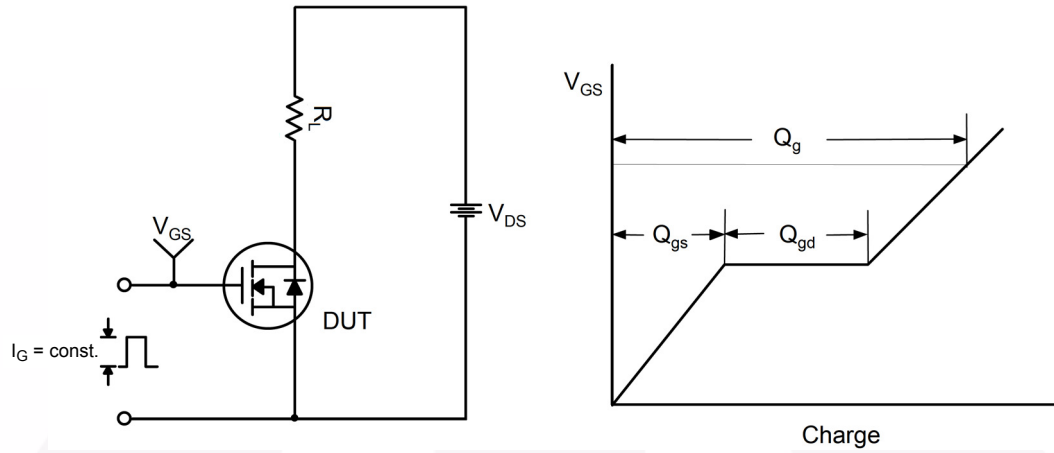

Figure 13. Gate Charge Test Circuit & Waveform

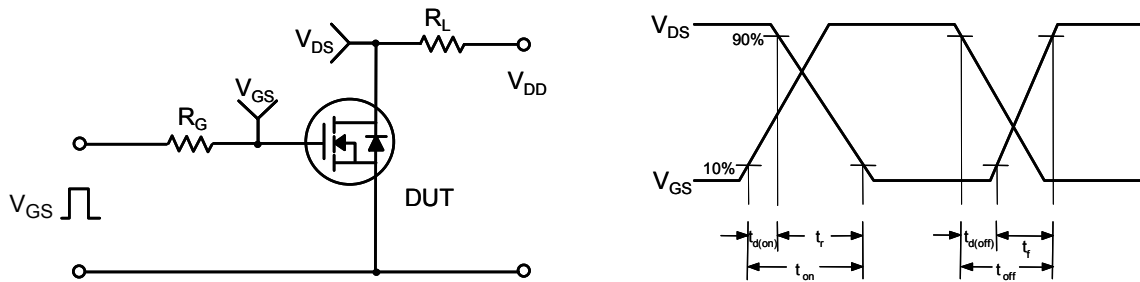

Figure 14. Resistive Switching Test Circuit & Waveforms

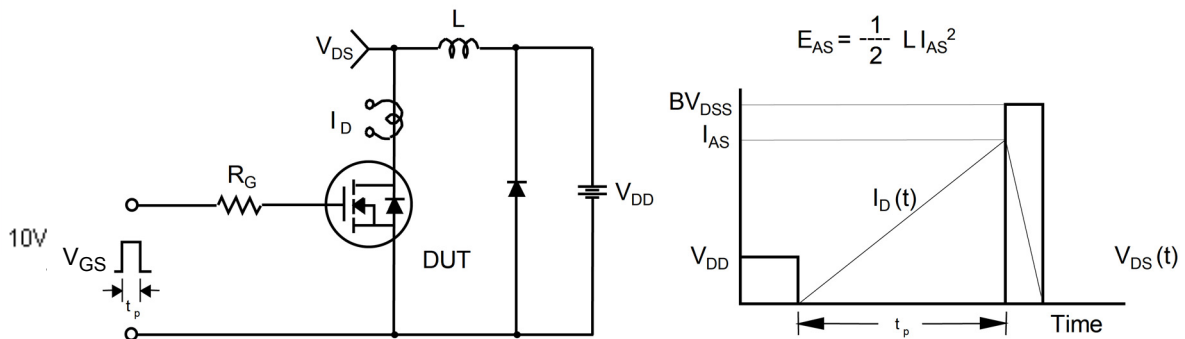

Figure 15. Unclamped Inductive Switching Test Circuit & Waveforms

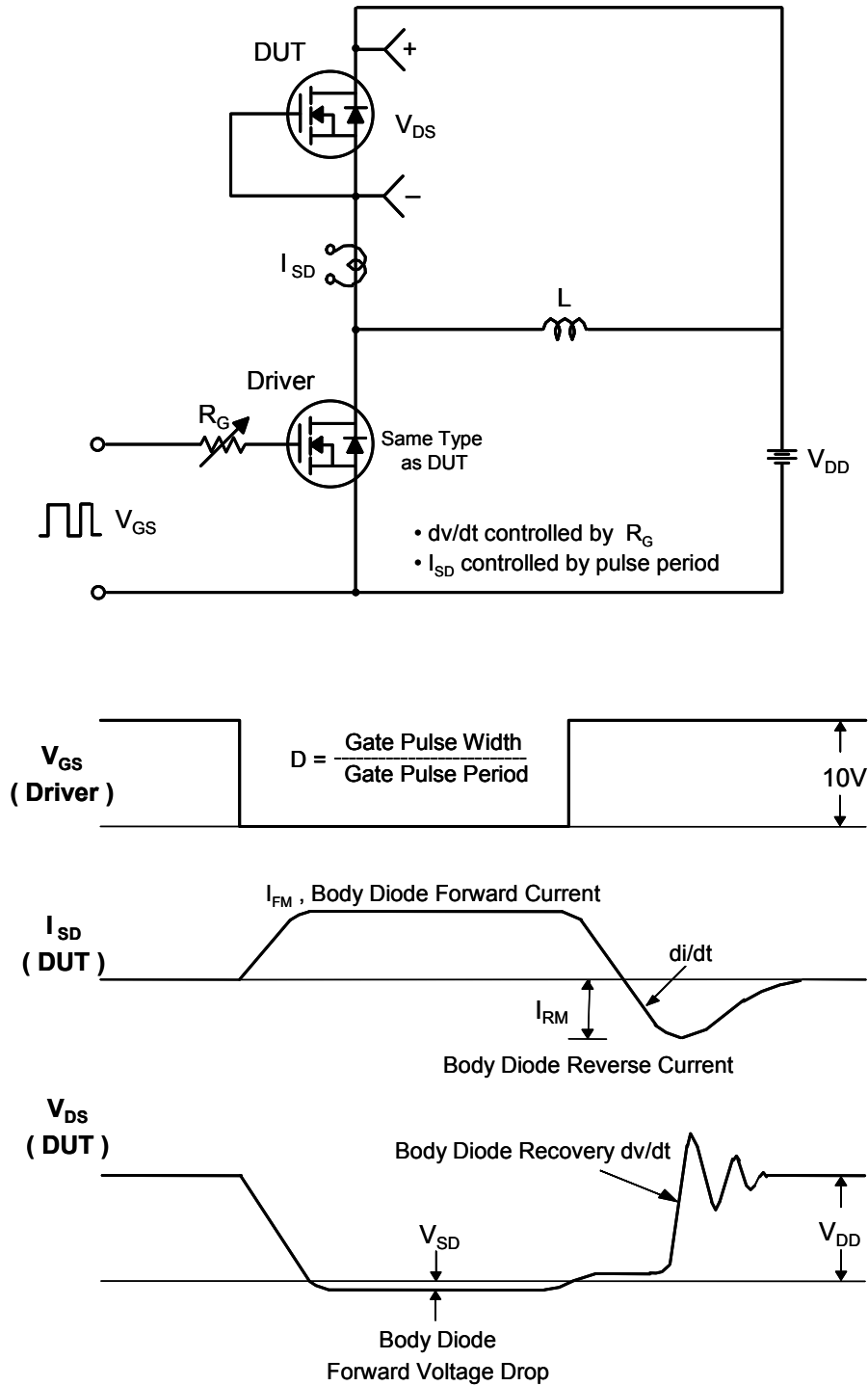
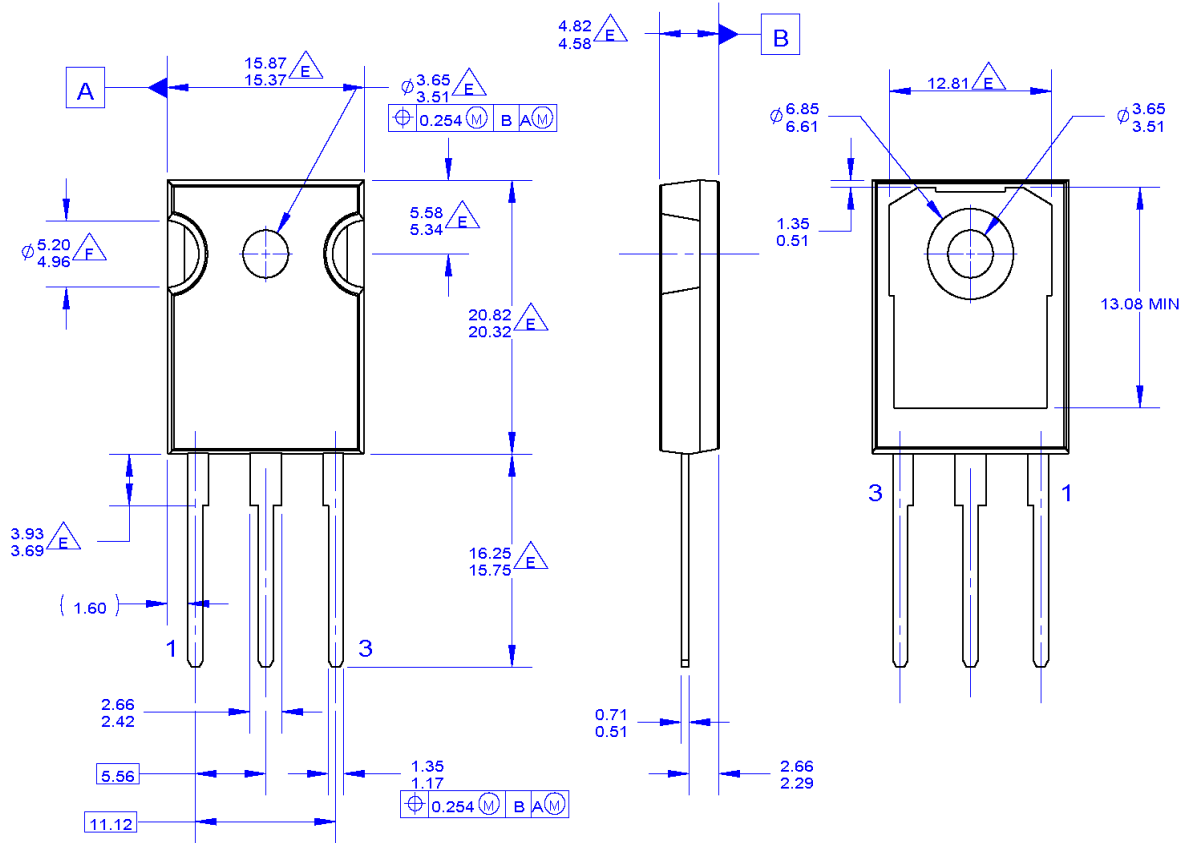

Figure 16. Peak Diode Recovery dv/dt Test Circuit & Waveforms

Mechanical Dimensions

TO-247 3L



NOTES: UNLESS OTHERWISE SPECIFIED.

- A. PACKAGE REFERENCE: JEDEC TO-247, ISSUE E, VARIATION AB, DATED JUNE, 2004.
- B. DIMENSIONS ARE EXCLUSIVE OF BURRS, MOLD FLASH, AND TIE BAR EXTRUSIONS.
- C. ALL DIMENSIONS ARE IN MILLIMETERS.
- D. DRAWING CONFORMS TO ASME Y14.5 - 1994

- E DOES NOT COMPLY JEDEC STANDARD VALUE
- F NOTCH MAY BE SQUARE
- G. DRAWING FILENAME: MKT-TO247A03_REV03

Figure 17. TO-247, Molded, 3 Lead, Jedec Variation AB

Package drawings are provided as a service to customers considering Fairchild components. Drawings may change in any manner without notice. Please note the revision and/or date on the drawing and contact a Fairchild Semiconductor representative to verify or obtain the most recent revision. Package specifications do not expand the terms of Fairchild's worldwide terms and conditions, specifically the warranty therein, which covers Fairchild products.





Always visit Fairchild Semiconductor's online packaging area for the most recent package drawings:

http://www.fairchildsemi.com/package/packageDetails.html?id=PN_TO247-003



TRADEMARKS

The following includes registered and unregistered trademarks and service marks, owned by Fairchild Semiconductor and/or its global subsidiaries, and is not intended to be an exhaustive list of all such trademarks.

- | | | | |
|---|---|---|---|
| AccuPower™ | F-PFS™ |  |  |
| AX-CAP®* | FRFET® | PowerTrench® | TinyBoost® |
| BitSiC™ | Global Power Resource™ | PowerXS™ | TinyBuck® |
| Build it Now™ | GreenBridge™ | Programmable Active Droop™ | TinyCalc™ |
| CorePLUS™ | Green FPS™ | QFET® | TinyLogic® |
| CorePOWER™ | Green FPS™ e-Series™ | QS™ | TINYOPTO™ |
| CROSSVOLT™ | Gmax™ | Quiet Series™ | TinyPower™ |
| CTL™ | GTO™ | RapidConfigure™ | TinyPWM™ |
| Current Transfer Logic™ | IntelliMAX™ |  | TinyWire™ |
| DEUXPEED® | ISOPLANAR™ | Saving our world, 1mW/W/kW at a time™ | TranSiC™ |
| Dual Cool™ | Marking Small Speakers Sound Louder and Better™ | SignalWise™ | TriFault Detect™ |
| EcoSPARK® | MegaBuck™ | SmartMax™ | TRUECURRENT®* |
| EfficientMax™ | MICROCOUPLER™ | SMART START™ | µSerDes™ |
| ESBC™ | MicroFET™ | Solutions for Your Success™ |  |
|  | MicroPak™ | SPM® | UHC® |
| Fairchild® | MicroPak2™ | STEALTH™ | Ultra FRFET™ |
| Fairchild Semiconductor® | MillerDrive™ | SuperFET® | UniFET™ |
| FACT Quiet Series™ | MotionMax™ | SuperSOT™-3 | VCX™ |
| FACT® | mWSaver® | SuperSOT™-6 | VisualMax™ |
| FAST® | OptoHiT™ | SuperSOT™-8 | VoltagePlus™ |
| FastvCore™ | OPTOLOGIC® | SupreMOS® | XS™ |
| FETBench™ | OPTOPLANAR® | SyncFET™ | ? ? TM |
| FPS™ | | Sync-Lock™ | |

*Trademarks of System General Corporation, used under license by Fairchild Semiconductor.

DISCLAIMER

FAIRCHILD SEMICONDUCTOR RESERVES THE RIGHT TO MAKE CHANGES WITHOUT FURTHER NOTICE TO ANY PRODUCTS HEREIN TO IMPROVE RELIABILITY, FUNCTION, OR DESIGN. FAIRCHILD DOES NOT ASSUME ANY LIABILITY ARISING OUT OF THE APPLICATION OR USE OF ANY PRODUCT OR CIRCUIT DESCRIBED HEREIN; NEITHER DOES IT CONVEY ANY LICENSE UNDER ITS PATENT RIGHTS, NOR THE RIGHTS OF OTHERS. THESE SPECIFICATIONS DO NOT EXPAND THE TERMS OF FAIRCHILD'S WORLDWIDE TERMS AND CONDITIONS, SPECIFICALLY THE WARRANTY THEREIN, WHICH COVERS THESE PRODUCTS.

LIFE SUPPORT POLICY

FAIRCHILD'S PRODUCTS ARE NOT AUTHORIZED FOR USE AS CRITICAL COMPONENTS IN LIFE SUPPORT DEVICES OR SYSTEMS WITHOUT THE EXPRESS WRITTEN APPROVAL OF FAIRCHILD SEMICONDUCTOR CORPORATION.

As used here in:

- Life support devices or systems are devices or systems which, (a) are intended for surgical implant into the body or (b) support or sustain life, and (c) whose failure to perform when properly used in accordance with instructions for use provided in the labeling, can be reasonably expected to result in a significant injury of the user.
- A critical component in any component of a life support, device, or system whose failure to perform can be reasonably expected to cause the failure of the life support device or system, or to affect its safety or effectiveness.

ANTI-COUNTERFEITING POLICY

Fairchild Semiconductor Corporation's Anti-Counterfeiting Policy. Fairchild's Anti-Counterfeiting Policy is also stated on our external website, www.fairchildsemi.com, under Sales Support.

Counterfeiting of semiconductor parts is a growing problem in the industry. All manufactures of semiconductor products are experiencing counterfeiting of their parts. Customers who inadvertently purchase counterfeit parts experience many problems such as loss of brand reputation, substandard performance, failed application, and increased cost of production and manufacturing delays. Fairchild is taking strong measures to protect ourselves and our customers from the proliferation of counterfeit parts. Fairchild strongly encourages customers to purchase Fairchild parts either directly from Fairchild or from Authorized Fairchild Distributors who are listed by country on our web page cited above. Products customers buy either from Fairchild directly or from Authorized Fairchild Distributors are genuine parts, have full traceability, meet Fairchild's quality standards for handling and storage and provide access to Fairchild's full range of up-to-date technical and product information. Fairchild and our Authorized Distributors will stand behind all warranties and will appropriately address and warranty issues that may arise. Fairchild will not provide any warranty coverage or other assistance for parts bought from Unauthorized Sources. Fairchild is committed to combat this global problem and encourage our customers to do their part in stopping this practice by buying direct or from authorized distributors.

PRODUCT STATUS DEFINITIONS

Definition of Terms

Datasheet Identification	Product Status	Definition
Advance Information	Formative / In Design	Datasheet contains the design specifications for product development. Specifications may change in any manner without notice.
Preliminary	First Production	Datasheet contains preliminary data; supplementary data will be published at a later date. Fairchild Semiconductor reserves the right to make changes at any time without notice to improve design.
No Identification Needed	Full Production	Datasheet contains final specifications. Fairchild Semiconductor reserves the right to make changes at any time without notice to improve the design.
Obsolete	Not In Production	Datasheet contains specifications on a product that is discontinued by Fairchild Semiconductor. The datasheet is for reference information only.

Mouser Electronics

Authorized Distributor

Click to View Pricing, Inventory, Delivery & Lifecycle Information:

[Fairchild Semiconductor:](#)

[FCH170N60](#)