



FCP150N65F

N-Channel SuperFET® II FRFET® MOSFET

650 V, 24 A, 150 mΩ

Features

- 700 V @ $T_J = 150^\circ\text{C}$
- Typ. $R_{DS(on)} = 133\text{ m}\Omega$
- Ultra Low Gate Charge (Typ. $Q_g = 72\text{ nC}$)
- Low Effective Output Capacitance (Typ. $C_{oss(eff.)} = 361\text{ pF}$)
- 100% Avalanche Tested
- RoHS Compliant

Applications

- LCD / LED / PDP TV
- Telecom / Server Power Supplies
- Solar Inverter
- AC - DC Power Supply

Description

SuperFET® II MOSFET is Fairchild Semiconductor's brand-new high voltage super-junction (SJ) MOSFET family that is utilizing charge balance technology for outstanding low on-resistance and lower gate charge performance. This technology is tailored to minimize conduction loss, provide superior switching performance, dv/dt rate and higher avalanche energy. Consequently, SuperFET II MOSFET is very suitable for the switching power applications such as PFC, server/telecom power, FPD TV power, ATX power and industrial power applications. SuperFET II FRFET® MOSFET's optimized body diode reverse recovery performance can remove additional component and improve system reliability.

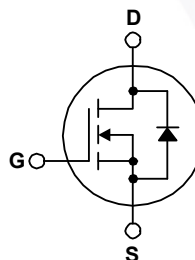
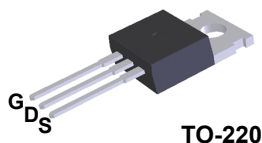

Absolute Maximum Ratings $T_C = 25^\circ\text{C}$ unless otherwise noted.

Symbol	Parameter	FCP150N65F	Unit
V_{DSS}	Drain to Source Voltage	650	V
V_{GSS}	Gate to Source Voltage	- DC	± 20
		- AC ($f > 1\text{ Hz}$)	± 30
I_D	Drain Current	- Continuous ($T_C = 25^\circ\text{C}$)	24
		- Continuous ($T_C = 100^\circ\text{C}$)	14.9
I_{DM}	Drain Current	- Pulsed (Note 1)	72
E_{AS}	Single Pulsed Avalanche Energy (Note 2)	663	mJ
I_{AR}	Avalanche Current (Note 1)	4.7	A
E_{AR}	Repetitive Avalanche Energy (Note 1)	2.98	mJ
dv/dt	MOSFET dv/dt	100	V/ns
	Peak Diode Recovery dv/dt (Note 3)	50	
P_D	Power Dissipation	($T_C = 25^\circ\text{C}$)	298
		- Derate Above 25°C	2.38
T_J, T_{STG}	Operating and Storage Temperature Range	-55 to +150	$^\circ\text{C}$
T_L	Maximum Lead Temperature for Soldering, 1/8" from Case for 5 Seconds	300	$^\circ\text{C}$

Thermal Characteristics

Symbol	Parameter	FCP150N65F	Unit
$R_{\theta JC}$	Thermal Resistance, Junction to Case, Max.	0.42	$^\circ\text{C/W}$
$R_{\theta JA}$	Thermal Resistance, Junction to Ambient, Max.	62.5	

FCP150N65F — N-Channel SuperFET® II FRFET® MOSFET

Package Marking and Ordering Information

Part Number	Top Mark	Package	Packing Method	Reel Size	Tape Width	Quantity
FCP150N65F	FCP150N65F	TO-220	Tube	N/A	N/A	50 units

Electrical Characteristics $T_C = 25^\circ\text{C}$ unless otherwise noted.

Symbol	Parameter	Test Conditions	Min.	Typ.	Max.	Unit
--------	-----------	-----------------	------	------	------	------

Off Characteristics

BV_{DSS}	Drain to Source Breakdown Voltage	$V_{GS} = 0\text{ V}, I_D = 10\text{ mA}, T_J = 25^\circ\text{C}$	650	-	-	V
		$V_{GS} = 0\text{ V}, I_D = 10\text{ mA}, T_J = 150^\circ\text{C}$	700	-	-	
$\Delta BV_{DSS} / \Delta T_J$	Breakdown Voltage Temperature Coefficient	$I_D = 10\text{ mA}$, Referenced to 25°C	-	0.72	-	$V/^\circ\text{C}$
I_{DSS}	Zero Gate Voltage Drain Current	$V_{DS} = 650\text{ V}, V_{GS} = 0\text{ V}$	-	-	10	μA
		$V_{DS} = 520\text{ V}, V_{GS} = 0\text{ V}, T_C = 125^\circ\text{C}$	-	86	-	
I_{GSS}	Gate to Body Leakage Current	$V_{GS} = \pm 20\text{ V}, V_{DS} = 0\text{ V}$	-	-	± 100	nA

On Characteristics

$V_{GS(th)}$	Gate Threshold Voltage	$V_{GS} = V_{DS}, I_D = 2.4\text{ mA}$	3	-	5	V
$R_{DS(on)}$	Static Drain to Source On Resistance	$V_{GS} = 10\text{ V}, I_D = 12\text{ A}$	-	133	150	$\text{m}\Omega$
g_{FS}	Forward Transconductance	$V_{DS} = 20\text{ V}, I_D = 12\text{ A}$	-	22	-	S

Dynamic Characteristics

C_{iss}	Input Capacitance	$V_{DS} = 100\text{ V}, V_{GS} = 0\text{ V}, f = 1\text{ MHz}$	-	2810	3737	pF
C_{oss}	Output Capacitance		-	91	121	pF
C_{riss}	Reverse Transfer Capacitance		-	0.77	-	pF
C_{oss}	Output Capacitance	$V_{DS} = 380\text{ V}, V_{GS} = 0\text{ V}, f = 1\text{ MHz}$	-	54	-	pF
$C_{oss\text{ eff.}}$	Effective Output Capacitance	$V_{DS} = 0\text{ V to } 400\text{ V}, V_{GS} = 0\text{ V}$	-	361	-	pF
$Q_{g(tot)}$	Total Gate Charge at 10V	$V_{DS} = 380\text{ V}, I_D = 12\text{ A}, V_{GS} = 10\text{ V}$	-	72	94	nC
Q_{gs}	Gate to Source Gate Charge		-	15	-	nC
Q_{gd}	Gate to Drain "Miller" Charge		(Note 4)	-	31	-
ESR	Equivalent Series Resistance	$f = 1\text{ MHz}$	-	0.69	-	Ω

Switching Characteristics

$t_{d(on)}$	Turn-On Delay Time	$V_{DD} = 380\text{ V}, I_D = 12\text{ A}, V_{GS} = 10\text{ V}, R_g = 4.7\text{ }\Omega$	-	28	66	ns	
t_r	Turn-On Rise Time		-	15	40	ns	
$t_{d(off)}$	Turn-Off Delay Time		(Note 4)	-	73	156	ns
t_f	Turn-Off Fall Time		(Note 4)	-	6	22	ns

Drain-Source Diode Characteristics

I_S	Maximum Continuous Drain to Source Diode Forward Current	-	-	24	A	
I_{SM}	Maximum Pulsed Drain to Source Diode Forward Current	-	-	72	A	
V_{SD}	Drain to Source Diode Forward Voltage	$V_{GS} = 0\text{ V}, I_{SD} = 12\text{ A}$	-	-	1.2	V
t_{rr}	Reverse Recovery Time	$V_{GS} = 0\text{ V}, I_{SD} = 12\text{ A}$	-	123	-	ns
Q_{rr}	Reverse Recovery Charge	$di_F/dt = 100\text{ A}/\mu\text{s}$	-	597	-	nC

Notes:

1. Repetitive rating: pulse width limited by maximum junction temperature.
2. $I_{AS} = 4.7\text{ A}, R_G = 25\text{ }\Omega$, Starting $T_J = 25^\circ\text{C}$.
3. $I_{SD} \leq 12\text{ A}, di/dt \leq 200\text{ A}/\mu\text{s}, V_{DD} \leq 380\text{ V}$, Starting $T_J = 25^\circ\text{C}$.
4. Essentially independent of operating temperature.

Typical Performance Characteristics

Figure 1. On-Region Characteristics

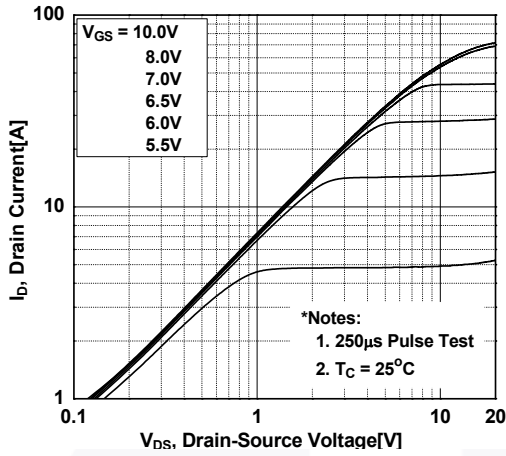

Figure 2. Transfer Characteristics

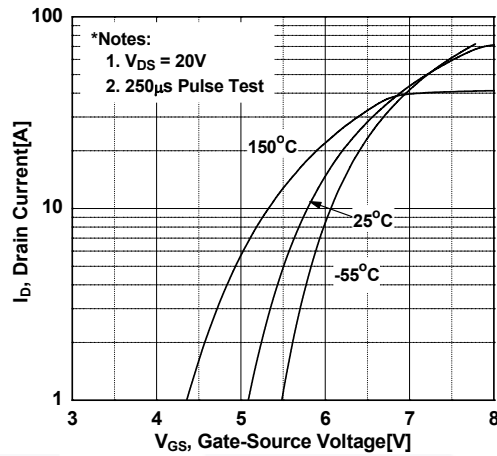

Figure 3. On-Resistance Variation vs. Drain Current and Gate Voltage

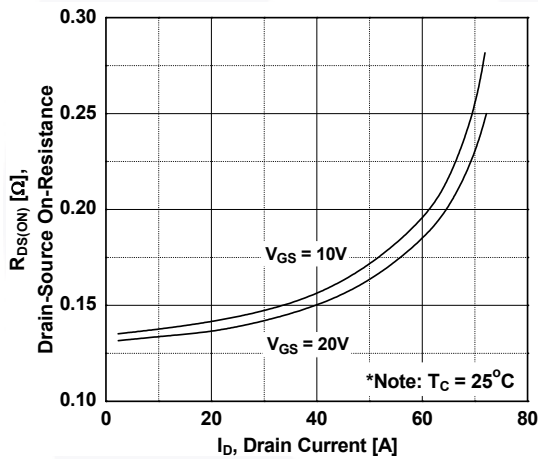

Figure 4. Body Diode Forward Voltage Variation vs. Source Current and Temperature

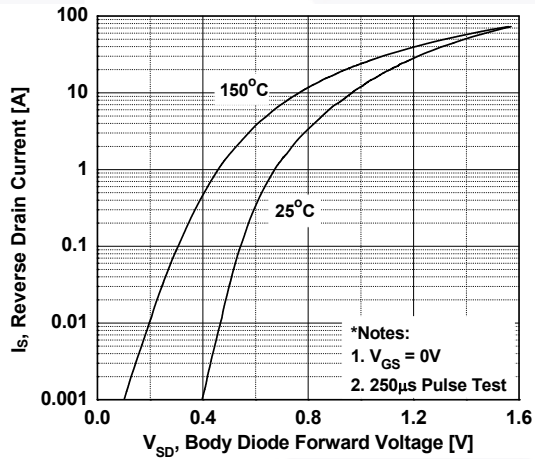

Figure 5. Capacitance Characteristics

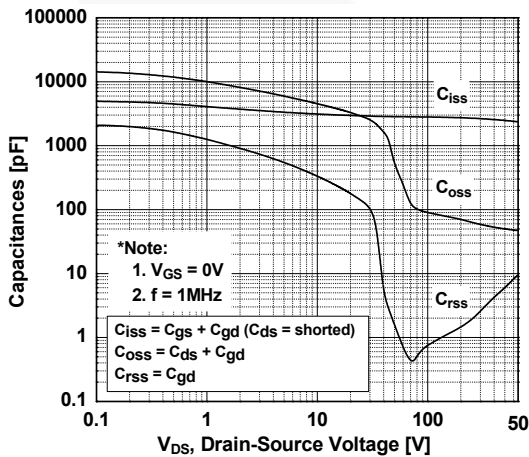
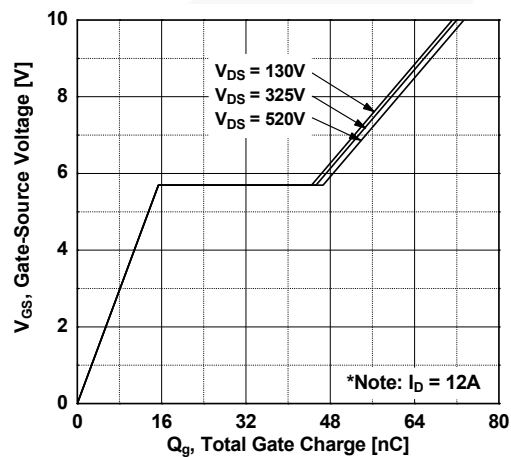

Figure 6. Gate Charge Characteristics



Typical Performance Characteristics (Continued)

Figure 7. Breakdown Voltage Variation vs. Temperature

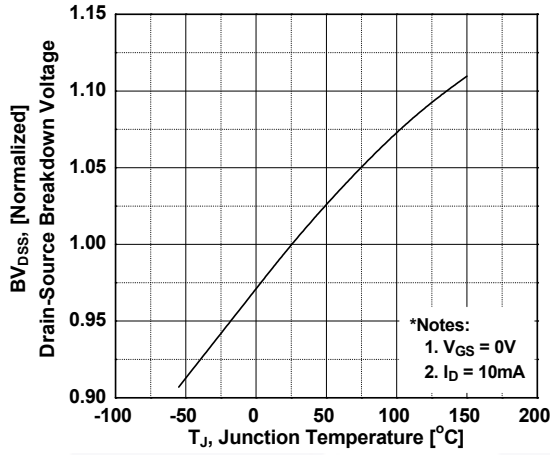

Figure 8. On-Resistance Variation vs. Temperature

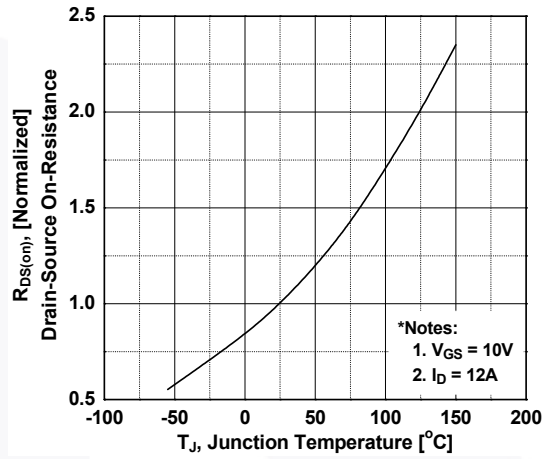

Figure 9. Maximum Safe Operating Area

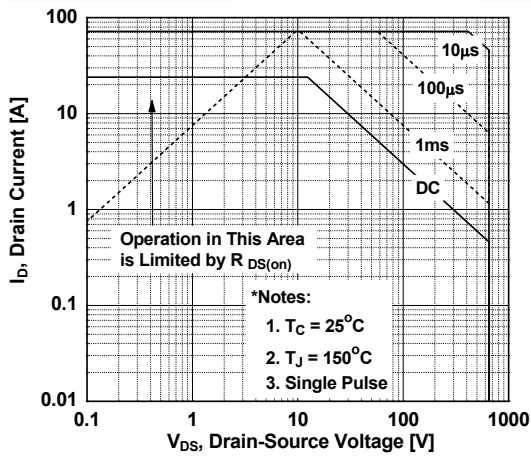

Figure 10. Maximum Drain Current vs. Case Temperature

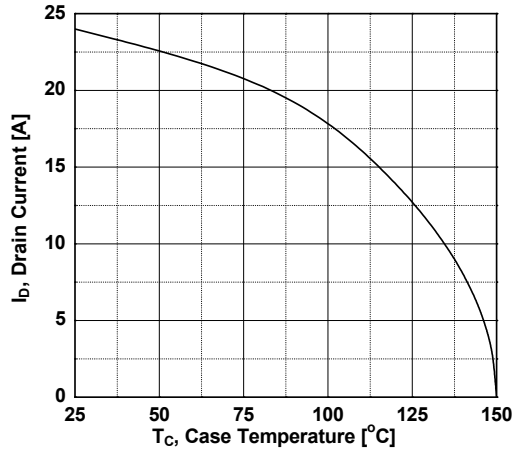
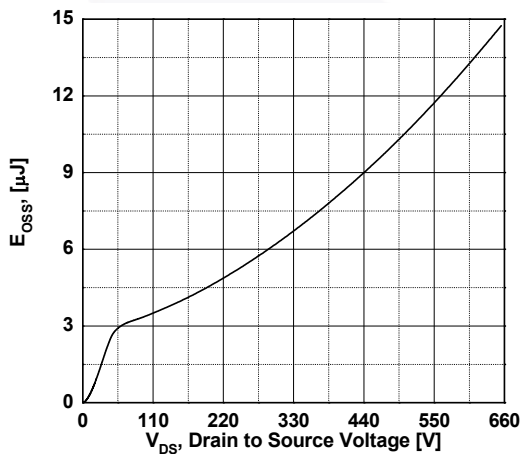
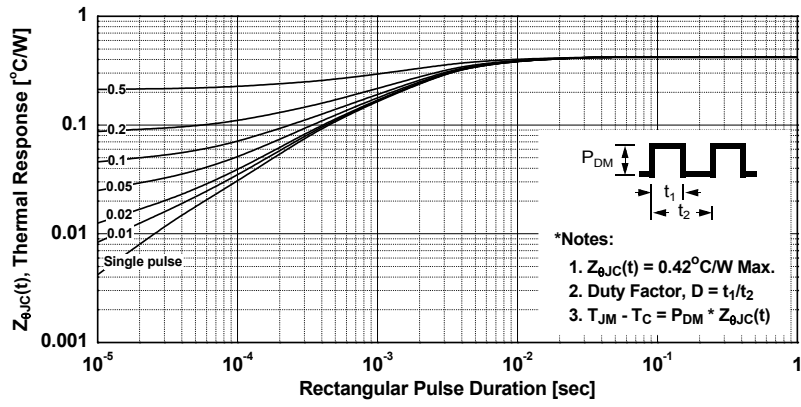

Figure 11. E_oss vs. Drain to Source Voltage



Typical Performance Characteristics (Continued)

Figure 12. Transient Thermal Response Curve



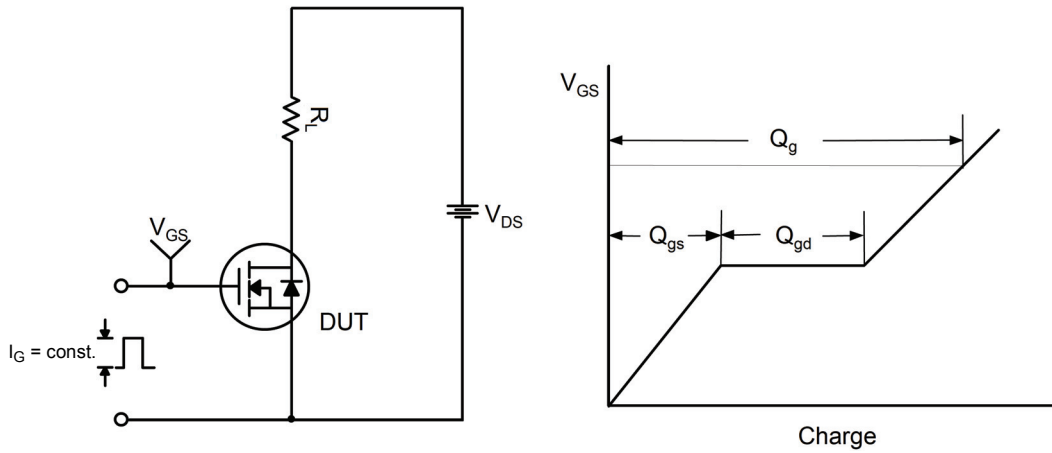

Figure 13. Gate Charge Test Circuit & Waveform



Figure 14. Resistive Switching Test Circuit & Waveforms



Figure 15. Unclamped Inductive Switching Test Circuit & Waveforms



Figure 16. Peak Diode Recovery dv/dt Test Circuit & Waveforms

Mechanical Dimensions

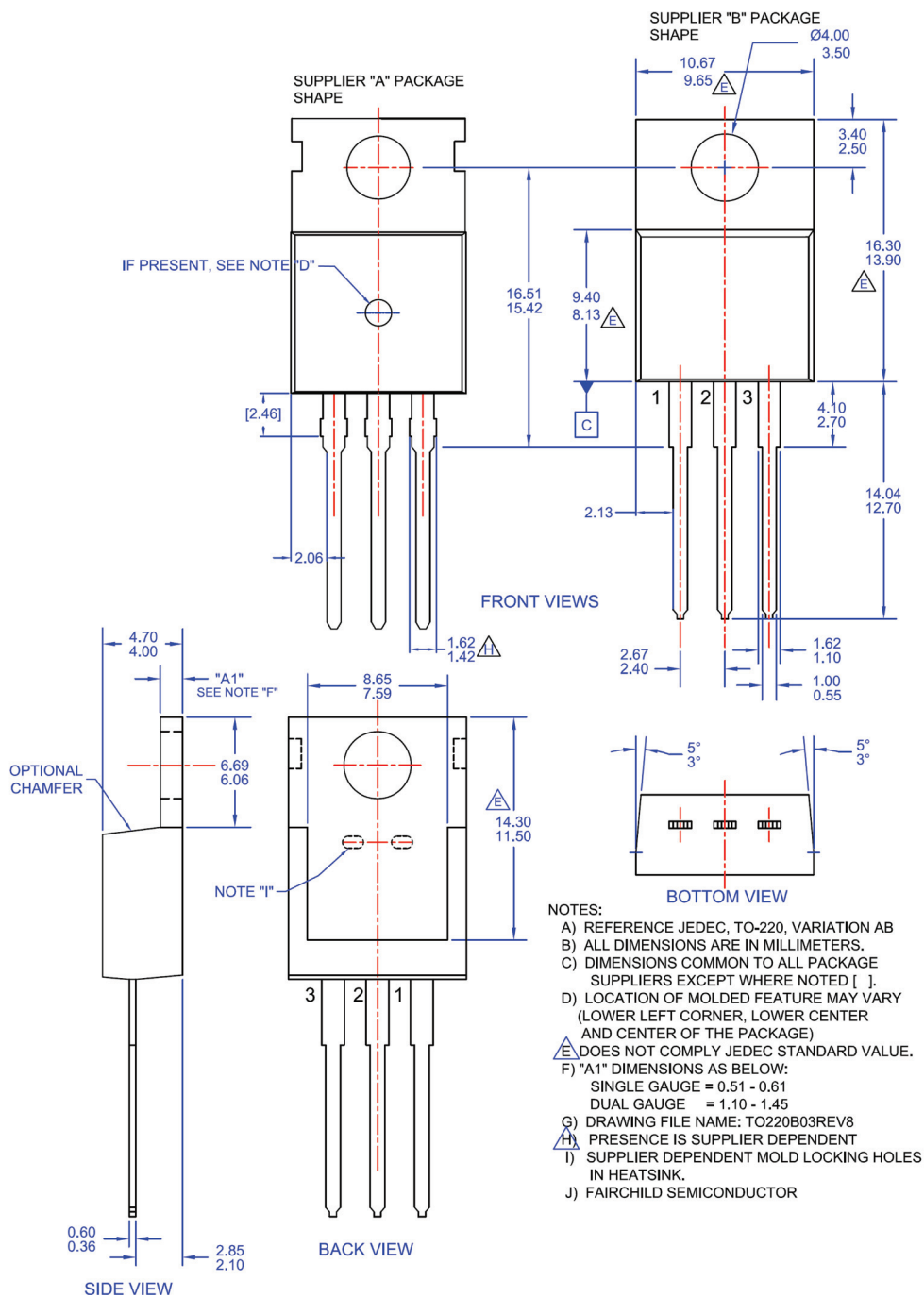

Figure 17. TO-220, Molded, 3-Lead, Jedec Variation AB

Package drawings are provided as a service to customers considering Fairchild components. Drawings may change in any manner without notice. Please note the revision and/or date on the drawing and contact a Fairchild Semiconductor representative to verify or obtain the most recent revision. Package specifications do not expand the terms of Fairchild's worldwide terms and conditions, specifically the warranty therein, which covers Fairchild products.

Always visit Fairchild Semiconductor's online packaging area for the most recent package drawings:

http://www.fairchildsemi.com/package/packageDetails.html?id=PN_TT220-003



TRADEMARKS

The following includes registered and unregistered trademarks and service marks, owned by Fairchild Semiconductor and/or its global subsidiaries, and is not intended to be an exhaustive list of all such trademarks.

- | | | | |
|--|---|---------------------------------------|------------------|
| AccuPower™ | F-PFS™ | OPTOPLANAR® | SYSTEM® |
| AttitudeEngine™ | FRFET® | PowerTrench® | GENERAL |
| Awinda® | Global Power ResourceSM | PowerXS™ | TinyBoost® |
| AX-CAP®* | GreenBridge™ | Programmable Active Droop™ | TinyBuck® |
| BitSiC™ | Green FPS™ | QFET® | TinyCalc™ |
| Build it Now™ | Green FPS™ e-Series™ | QS™ | TinyLogic® |
| CorePLUS™ | Gmax™ | Quiet Series™ | TINYOPTO™ |
| CorePOWER™ | GTO™ | RapidConfigure™ | TinyPower™ |
| CROSSVOLT™ | IntelliMAX™ | Saving our world, 1mW/W/kW at a time™ | TinyPWM™ |
| CTL™ | ISOPLANAR™ | SignalWise™ | TinyWire™ |
| Current Transfer Logic™ | Marking Small Speakers Sound Louder and Better™ | SmartMax™ | TranSiC™ |
| DEUXPEED® | MegaBuck™ | SMART START™ | TriFault Detect™ |
| Dual Cool™ | MICROCOUPLER™ | Solutions for Your Success™ | TRUECURRENT®* |
| EcoSPARK® | MicroFET™ | SPM® | μSerDes™ |
| EfficientMax™ | MicroPak™ | STEALTH™ | UHC® |
| ESBC™ | MicroPak2™ | SuperFET® | Ultra FRFET™ |
|  Fairchild® | MillerDrive™ | SuperSOT™-3 | UniFET™ |
| Fairchild Semiconductor® | MotionMax™ | SuperSOT™-6 | VCX™ |
| FACT Quiet Series™ | MotionGrid® | SuperSOT™-8 | VisualMax™ |
| FACT® | MTi® | SupreMOS® | VoltagePlus™ |
| FAST® | MTx® | SyncFET™ | XS™ |
| FastvCore™ | MVN® | Sync-Lock™ | Xsens™ |
| FETBench™ | mWSaver® | | 仙童™ |
| FPS™ | OptoHiT™ | | |
| | OPTOLOGIC® | | |

*Trademarks of System General Corporation, used under license by Fairchild Semiconductor.

DISCLAIMER

FAIRCHILD SEMICONDUCTOR RESERVES THE RIGHT TO MAKE CHANGES WITHOUT FURTHER NOTICE TO ANY PRODUCTS HEREIN TO IMPROVE RELIABILITY, FUNCTION, OR DESIGN. TO OBTAIN THE LATEST, MOST UP-TO-DATE DATASHEET AND PRODUCT INFORMATION, VISIT OUR WEBSITE AT [HTTP://WWW.FAIRCHILDSEMI.COM](http://www.fairchildsemi.com). FAIRCHILD DOES NOT ASSUME ANY LIABILITY ARISING OUT OF THE APPLICATION OR USE OF ANY PRODUCT OR CIRCUIT DESCRIBED HEREIN; NEITHER DOES IT CONVEY ANY LICENSE UNDER ITS PATENT RIGHTS, NOR THE RIGHTS OF OTHERS. THESE SPECIFICATIONS DO NOT EXPAND THE TERMS OF FAIRCHILD'S WORLDWIDE TERMS AND CONDITIONS, SPECIFICALLY THE WARRANTY THEREIN, WHICH COVERS THESE PRODUCTS.

LIFE SUPPORT POLICY

FAIRCHILD'S PRODUCTS ARE NOT AUTHORIZED FOR USE AS CRITICAL COMPONENTS IN LIFE SUPPORT DEVICES OR SYSTEMS WITHOUT THE EXPRESS WRITTEN APPROVAL OF FAIRCHILD SEMICONDUCTOR CORPORATION.

As used here in:

- Life support devices or systems are devices or systems which, (a) are intended for surgical implant into the body or (b) support or sustain life, and (c) whose failure to perform when properly used in accordance with instructions for use provided in the labeling, can be reasonably expected to result in a significant injury of the user.
- A critical component in any component of a life support, device, or system whose failure to perform can be reasonably expected to cause the failure of the life support device or system, or to affect its safety or effectiveness.

ANTI-COUNTERFEITING POLICY

Fairchild Semiconductor Corporation's Anti-Counterfeiting Policy. Fairchild's Anti-Counterfeiting Policy is also stated on our external website, www.fairchildsemi.com, under Sales Support. Counterfeiting of semiconductor parts is a growing problem in the industry. All manufactures of semiconductor products are experiencing counterfeiting of their parts. Customers who inadvertently purchase counterfeit parts experience many problems such as loss of brand reputation, substandard performance, failed application, and increased cost of production and manufacturing delays. Fairchild is taking strong measures to protect ourselves and our customers from the proliferation of counterfeit parts. Fairchild strongly encourages customers to purchase Fairchild parts either directly from Fairchild or from Authorized Fairchild Distributors who are listed by country on our web page cited above. Products customers buy either from Fairchild directly or from Authorized Fairchild Distributors are genuine parts, have full traceability, meet Fairchild's quality standards for handling and storage and provide access to Fairchild's full range of up-to-date technical and product information. Fairchild and our Authorized Distributors will stand behind all warranties and will appropriately address and warranty issues that may arise. Fairchild will not provide any warranty coverage or other assistance for parts bought from Unauthorized Sources. Fairchild is committed to combat this global problem and encourage our customers to do their part in stopping this practice by buying direct or from authorized distributors.

PRODUCT STATUS DEFINITIONS

Definition of Terms

Datasheet Identification	Product Status	Definition
Advance Information	Formative / In Design	Datasheet contains the design specifications for product development. Specifications may change in any manner without notice.
Preliminary	First Production	Datasheet contains preliminary data; supplementary data will be published at a later date. Fairchild Semiconductor reserves the right to make changes at any time without notice to improve design.
No Identification Needed	Full Production	Datasheet contains final specifications. Fairchild Semiconductor reserves the right to make changes at any time without notice to improve the design.
Obsolete	Not In Production	Datasheet contains specifications on a product that is discontinued by Fairchild Semiconductor. The datasheet is for reference information only.

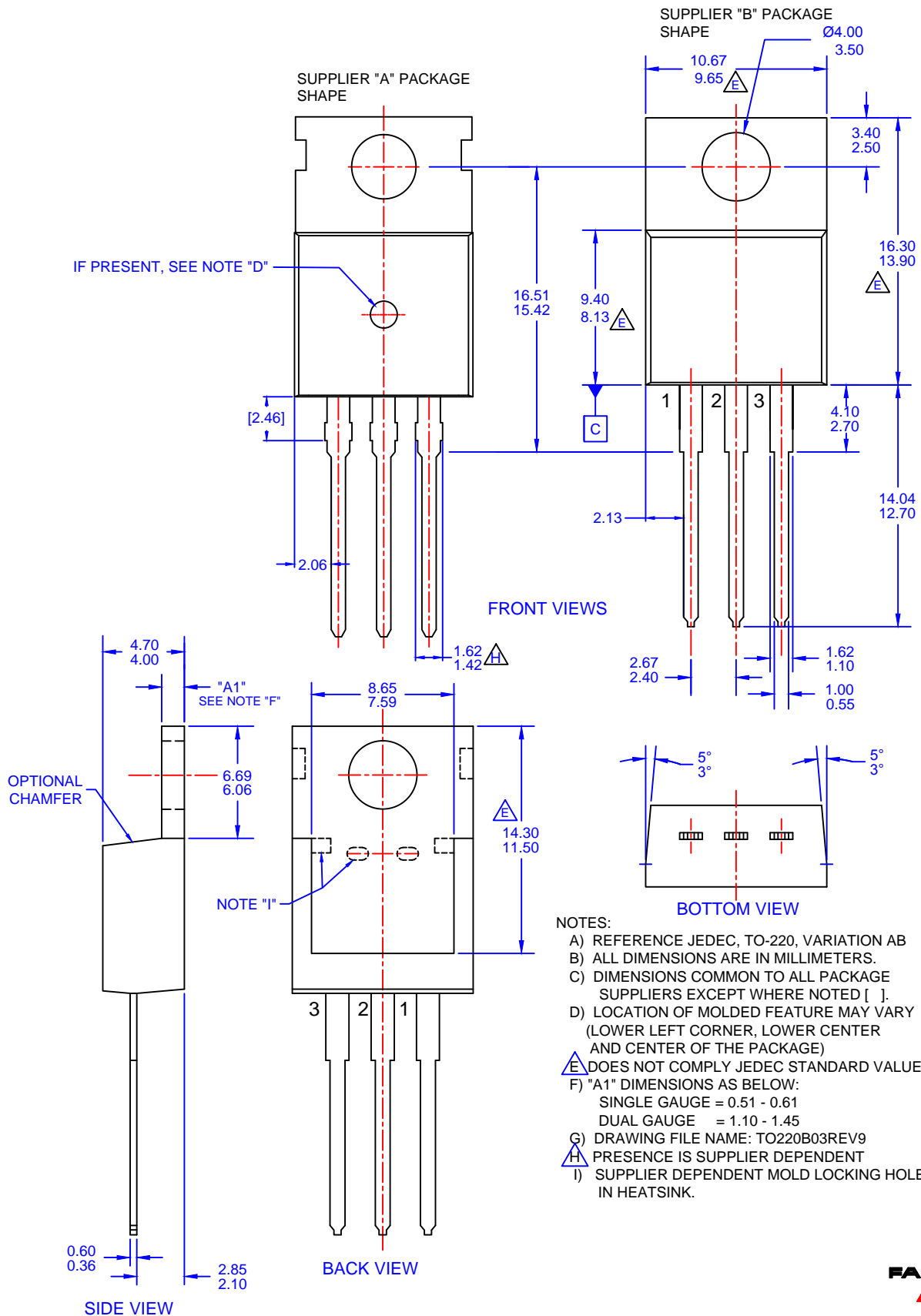

- NOTES:
- A) REFERENCE JEDEC, TO-220, VARIATION AB
 - B) ALL DIMENSIONS ARE IN MILLIMETERS.
 - C) DIMENSIONS COMMON TO ALL PACKAGE SUPPLIERS EXCEPT WHERE NOTED [].
 - D) LOCATION OF MOLDED FEATURE MAY VARY (LOWER LEFT CORNER, LOWER CENTER AND CENTER OF THE PACKAGE)
 - E) DOES NOT COMPLY JEDEC STANDARD VALUE.
 - F) "A1" DIMENSIONS AS BELOW:
 SINGLE GAUGE = 0.51 - 0.61
 DUAL GAUGE = 1.10 - 1.45
 - G) DRAWING FILE NAME: TO220B03REV9
 - H) PRESENCE IS SUPPLIER DEPENDENT
 - I) SUPPLIER DEPENDENT MOLD LOCKING HOLES IN HEATSINK.



TRADEMARKS

The following includes registered and unregistered trademarks and service marks, owned by Fairchild Semiconductor and/or its global subsidiaries, and is not intended to be an exhaustive list of all such trademarks.

- AccuPower™
- AttitudeEngine™
- Awinda®
- AX-CAP®*
- BitSiC™
- Build it Now™
- CorePLUS™
- CorePOWER™
- CROSSVOL™
- CTL™
- Current Transfer Logic™
- DEUXPEED®
- Dual Cool™
- EcoSPARK®
- EfficientMax™
- ESBC™
- F**™
- Fairchild®
- Fairchild Semiconductor®
- FACT Quiet Series™
- FACT®
- FastvCore™
- FETBench™
- FPS™
- F-PFS™
- FRFET®
- Global Power ResourceSM
- GreenBridge™
- Green FPS™
- Green FPS™ e-Series™
- Gmax™
- GTO™
- IntelliMAX™
- ISOPLANAR™
- Making Small Speakers Sound Louder and Better™
- MegaBuck™
- MICROCOUPLER™
- MicroFET™
- MicroPak™
- MicroPak2™
- MillerDrive™
- MotionMax™
- MotionGrid®
- MTi®
- MTx®
- MVN®
- mWSaver®
- OptoHiT™
- OPTOLOGIC®
- OPTOPLANAR®
- ®
- Power Supply WebDesigner™
- PowerTrench®
- PowerXS™
- Programmable Active Droop™
- QFET®
- QS™
- Quiet Series™
- RapidConfigure™
- ™
- Saving our world, 1mW/W/kW at a time™
- SignalWise™
- SmartMax™
- SMART START™
- Solutions for Your Success™
- SPM®
- STEALTH™
- SuperFET®
- SuperSOT™-3
- SuperSOT™-6
- SuperSOT™-8
- SupreMOS®
- SyncFET™
- Sync-Lock™
- SYSTEM GENERAL®
- TinyBoost®
- TinyBuck®
- TinyCalc™
- TinyLogic®
- TINYOPTO™
- TinyPower™
- TinyPWM™
- TinyWire™
- TranSiC™
- TriFault Detect™
- TRUECURRENT®*
- μSerDes™
- SerDes®
- UHC®
- Ultra FRFET™
- UniFET™
- VcX™
- VisualMax™
- VoltagePlus™
- XS™
- Xsens™
- 仙童®

* Trademarks of System General Corporation, used under license by Fairchild Semiconductor.

DISCLAIMER

FAIRCHILD SEMICONDUCTOR RESERVES THE RIGHT TO MAKE CHANGES WITHOUT FURTHER NOTICE TO ANY PRODUCTS HEREIN TO IMPROVE RELIABILITY, FUNCTION, OR DESIGN. TO OBTAIN THE LATEST, MOST UP-TO-DATE DATASHEET AND PRODUCT INFORMATION, VISIT OUR WEBSITE AT [HTTP://WWW.FAIRCHILDSEMI.COM](http://www.fairchildsemi.com). FAIRCHILD DOES NOT ASSUME ANY LIABILITY ARISING OUT OF THE APPLICATION OR USE OF ANY PRODUCT OR CIRCUIT DESCRIBED HEREIN; NEITHER DOES IT CONVEY ANY LICENSE UNDER ITS PATENT RIGHTS, NOR THE RIGHTS OF OTHERS. THESE SPECIFICATIONS DO NOT EXPAND THE TERMS OF FAIRCHILD'S WORLDWIDE TERMS AND CONDITIONS, SPECIFICALLY THE WARRANTY THEREIN, WHICH COVERS THESE PRODUCTS.

AUTHORIZED USE

Unless otherwise specified in this data sheet, this product is a standard commercial product and is not intended for use in applications that require extraordinary levels of quality and reliability. This product may not be used in the following applications, unless specifically approved in writing by a Fairchild officer: (1) automotive or other transportation, (2) military/aerospace, (3) any safety critical application – including life critical medical equipment – where the failure of the Fairchild product reasonably would be expected to result in personal injury, death or property damage. Customer's use of this product is subject to agreement of this Authorized Use policy. In the event of an unauthorized use of Fairchild's product, Fairchild accepts no liability in the event of product failure. In other respects, this product shall be subject to Fairchild's Worldwide Terms and Conditions of Sale, unless a separate agreement has been signed by both Parties.

ANTI-COUNTERFEITING POLICY

Fairchild Semiconductor Corporation's Anti-Counterfeiting Policy. Fairchild's Anti-Counterfeiting Policy is also stated on our external website, www.fairchildsemi.com, under Terms of Use

Counterfeiting of semiconductor parts is a growing problem in the industry. All manufacturers of semiconductor products are experiencing counterfeiting of their parts. Customers who inadvertently purchase counterfeit parts experience many problems such as loss of brand reputation, substandard performance, failed applications, and increased cost of production and manufacturing delays. Fairchild is taking strong measures to protect ourselves and our customers from the proliferation of counterfeit parts. Fairchild strongly encourages customers to purchase Fairchild parts either directly from Fairchild or from Authorized Fairchild Distributors who are listed by country on our web page cited above. Products customers buy either from Fairchild directly or from Authorized Fairchild Distributors are genuine parts, have full traceability, meet Fairchild's quality standards for handling and storage and provide access to Fairchild's full range of up-to-date technical and product information. Fairchild and our Authorized Distributors will stand behind all warranties and will appropriately address any warranty issues that may arise. Fairchild will not provide any warranty coverage or other assistance for parts bought from Unauthorized Sources. Fairchild is committed to combat this global problem and encourage our customers to do their part in stopping this practice by buying direct or from authorized distributors.

PRODUCT STATUS DEFINITIONS

Definition of Terms

Datasheet Identification	Product Status	Definition
Advance Information	Formative / In Design	Datasheet contains the design specifications for product development. Specifications may change in any manner without notice.
Preliminary	First Production	Datasheet contains preliminary data; supplementary data will be published at a later date. Fairchild Semiconductor reserves the right to make changes at any time without notice to improve design.
No Identification Needed	Full Production	Datasheet contains final specifications. Fairchild Semiconductor reserves the right to make changes at any time without notice to improve the design.
Obsolete	Not In Production	Datasheet contains specifications on a product that is discontinued by Fairchild Semiconductor. The datasheet is for reference information only.

Rev. I77

Mouser Electronics

Authorized Distributor

Click to View Pricing, Inventory, Delivery & Lifecycle Information:

[Fairchild Semiconductor:](#)

[FCP150N65F](#)