



March 2015



# FDD8782/FDU8782 N-Channel PowerTrench<sup>®</sup> MOSFET 25V, 35A, 11mΩ

## General Description

This N-Channel MOSFET has been designed specifically to improve the overall efficiency of DC/DC converters using either synchronous or conventional switching PWM controllers. It has been optimized for low gate charge, low  $r_{DS(on)}$  and fast switching speed.

## Features

- Max  $r_{DS(on)}$  = 11.0mΩ at  $V_{GS} = 10V$ ,  $I_D = 35A$
- Max  $r_{DS(on)}$  = 14.0mΩ at  $V_{GS} = 4.5V$ ,  $I_D = 35A$
- Low gate charge:  $Q_{g(10)}$  = 18nC(Typ),  $V_{GS} = 10V$
- Low gate resistance
- Avalanche rated and 100% tested
- RoHS Compliant



## Application

- Vcore DC-DC for Desktop Computers and Servers
- VRM for Intermediate Bus Architecture

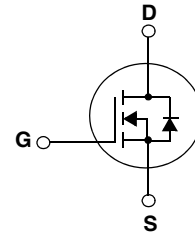
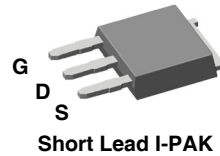
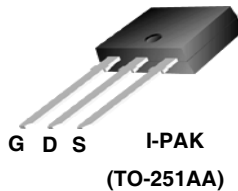
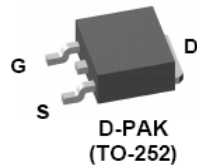

## MOSFET Maximum Ratings $T_C = 25^\circ C$ unless otherwise noted

Symbol	Parameter	Ratings	Units
$V_{DS}$	Drain to Source Voltage	25	V
$V_{GS}$	Gate to Source Voltage	±20	V
$I_D$	Drain Current -Continuous (Package Limited)	35	A
	-Continuous (Die Limited)	54	
	-Pulsed (Note 1)	321	
$E_{AS}$	Single Pulse Avalanche Energy (Note 2)	72	mJ
$P_D$	Power Dissipation	50	W
$T_J, T_{STG}$	Operating and Storage Temperature	-55 to 175	°C

## Thermal Characteristics

$R_{\theta JC}$	Thermal Resistance, Junction to Case TO-252, TO-251	3.0	°C/W
$R_{\theta JA}$	Thermal Resistance, Junction to Ambient TO-252, TO-251	100	°C/W
$R_{\theta JA}$	Thermal Resistance, Junction to Ambient TO-252, 1in <sup>2</sup> copper pad area	52	°C/W

## Package Marking and Ordering Information

Device Marking	Device	Package	Reel Size	Tape Width	Quantity
FDD8782	FDD8782	TO-252AA	13"	16mm	2500 units
FDU8782	FDU8782	TO-251AA	N/A(Tube)	N/A	75 units
FDU8782	FDU8782_F071	TO-251AA	N/A(Tube)	N/A	75 units

**Electrical Characteristics**  $T_J = 25^\circ\text{C}$  unless otherwise noted

Symbol	Parameter	Test Conditions	Min	Typ	Max	Units
--------	-----------	-----------------	-----	-----	-----	-------

**Off Characteristics**

$B_{VDSS}$	Drain to Source Breakdown Voltage	$I_D = 250\mu\text{A}, V_{GS} = 0\text{V}$	25			V
$\frac{\Delta B_{VDSS}}{\Delta T_J}$	Breakdown Voltage Temperature Coefficient	$I_D = 250\mu\text{A}$ , referenced to $25^\circ\text{C}$		14.3		mV/ $^\circ\text{C}$
$I_{DSS}$	Zero Gate Voltage Drain Current	$V_{DS} = 20\text{V}, V_{GS} = 0\text{V}$ $T_J = 150^\circ\text{C}$			1 250	$\mu\text{A}$
$I_{GSS}$	Gate to Source Leakage Current	$V_{GS} = \pm 20\text{V}$			$\pm 100$	nA

**On Characteristics**

$V_{GS(th)}$	Gate to Source Threshold Voltage	$V_{GS} = V_{DS}, I_D = 250\mu\text{A}$	1.2	1.7	2.5	V
$\frac{\Delta V_{GS(th)}}{\Delta T_J}$	Gate to Source Threshold Voltage Temperature Coefficient	$I_D = 250\mu\text{A}$ , referenced to $25^\circ\text{C}$		-6.5		mV/ $^\circ\text{C}$
$r_{DS(on)}$	Drain to Source On Resistance	$V_{GS} = 10\text{V}, I_D = 35\text{A}$ $V_{GS} = 4.5\text{V}, I_D = 35\text{A}$ $V_{GS} = 10\text{V}, I_D = 35\text{A}$ $T_J = 175^\circ\text{C}$		8.5 11.0 12.1	11.0 14.0 18.0	$\text{m}\Omega$

**Dynamic Characteristics**

$C_{iss}$	Input Capacitance	$V_{DS} = 13\text{V}, V_{GS} = 0\text{V}, f = 1\text{MHz}$		920	1220	pF
$C_{oss}$	Output Capacitance			230	310	pF
$C_{rss}$	Reverse Transfer Capacitance			160	240	pF
$R_g$	Gate Resistance		$f = 1\text{MHz}$		1.4	

**Switching Characteristics**

$t_{d(on)}$	Turn-On Delay Time	$V_{DD} = 13\text{V}, I_D = 35\text{A}$ $V_{GS} = 10\text{V}, R_{GS} = 9\Omega$		7	14	ns	
$t_r$	Rise Time			9	18	ns	
$t_{d(off)}$	Turn-Off Delay Time			22	36	ns	
$t_f$	Fall Time			14	25	ns	
$Q_g$	Total Gate Charge		$V_{GS} = 0\text{V to } 10\text{V}$		18	25	nC
$Q_g$	Total Gate Charge	$V_{GS} = 0\text{V to } 5\text{V}$	$V_{DD} = 13\text{V}$ $I_D = 35\text{A}$ $I_g = 1.0\text{mA}$		9.4	13	nC
$Q_{gs}$	Gate to Source Gate Charge				3.1		nC
$Q_{gd}$	Gate to Drain "Miller" Charge				4.0		nC

**Drain-Source Diode Characteristics**

$V_{SD}$	Source to Drain Diode Forward Voltage	$V_{GS} = 0\text{V}, I_S = 35\text{A}$ $V_{GS} = 0\text{V}, I_S = 15\text{A}$		0.96 0.86	1.25 1.2	V
$t_{rr}$	Reverse Recovery Time	$I_F = 35\text{A}, di/dt = 100\text{A}/\mu\text{s}$		25	38	ns
$Q_{rr}$	Reverse Recovery Charge	$I_F = 35\text{A}, di/dt = 100\text{A}/\mu\text{s}$		17	26	nC

**Notes:**

- 1: Pulse time < 300 $\mu\text{s}$ , Duty cycle = 2%.
- 2: Starting  $T_J = 25^\circ\text{C}$ ,  $L = 1.0\text{mH}$ ,  $I_{AS} = 12\text{A}$ ,  $V_{DD} = 23\text{V}$ ,  $V_{GS} = 10\text{V}$ .

**Typical Characteristics**  $T_J = 25^\circ\text{C}$  unless otherwise noted

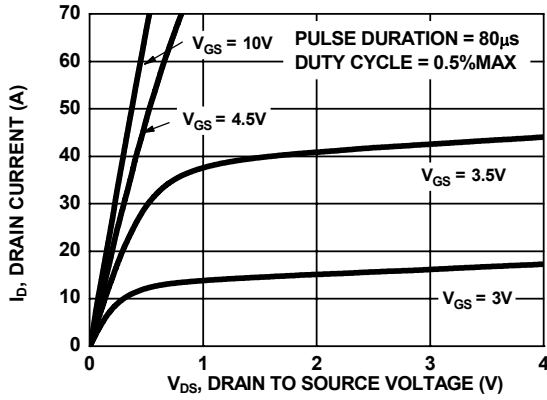

Figure 1. On Region Characteristics

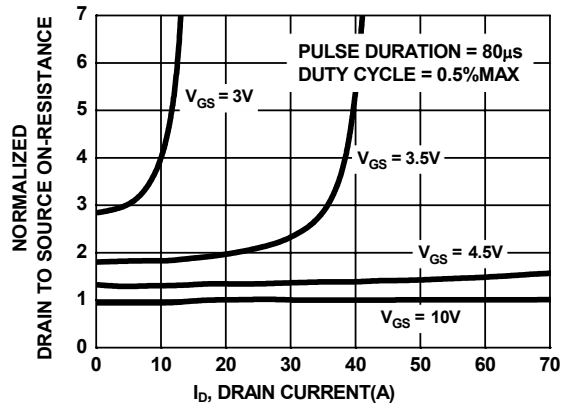

Figure 2. Normalized On-Resistance vs Drain Current and Gate Voltage

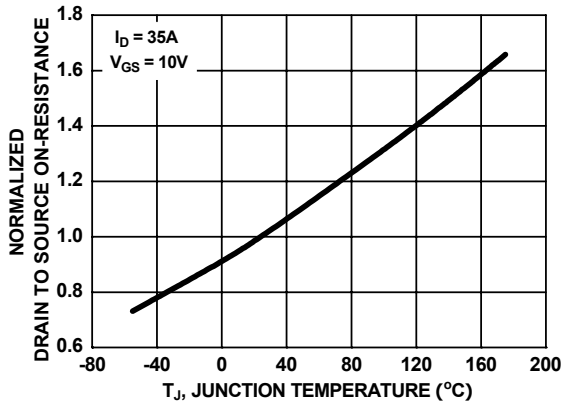

Figure 3. Normalized On Resistance vs Junction Temperature

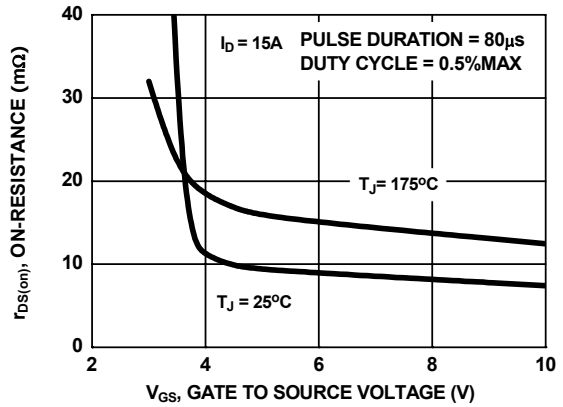

Figure 4. On-Resistance vs Gate to Source Voltage

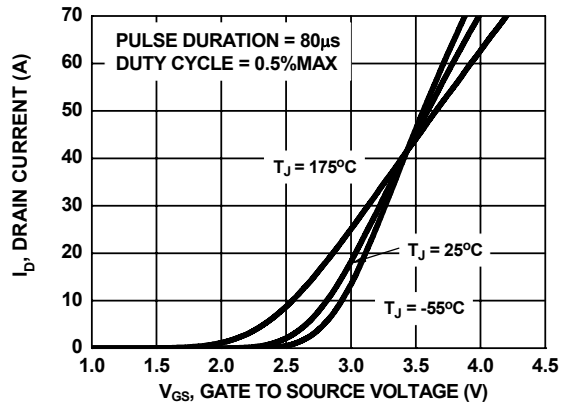

Figure 5. Transfer Characteristics

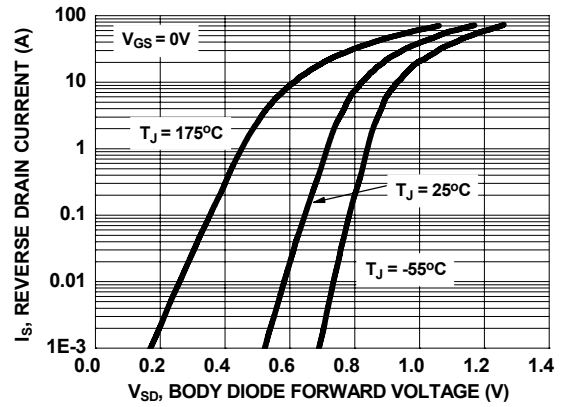

Figure 6. Source to Drain Diode Forward Voltage vs Source Current

**Typical Characteristics**  $T_J = 25^\circ\text{C}$  unless otherwise noted

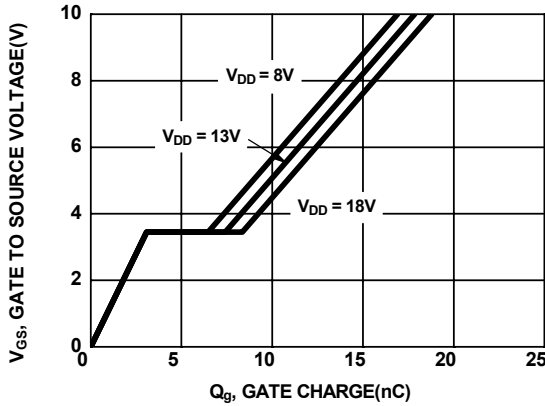

Figure 7. Gate Charge Characteristics

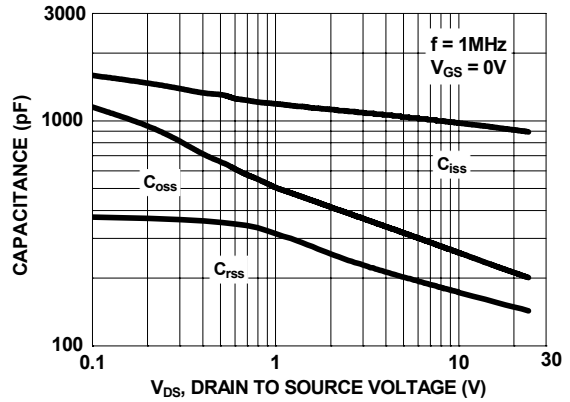

Figure 8. Capacitance vs Drain to Source Voltage

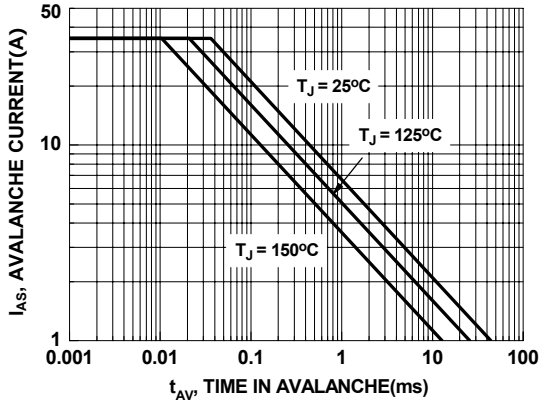

Figure 9. Unclamped Inductive Switching Capability

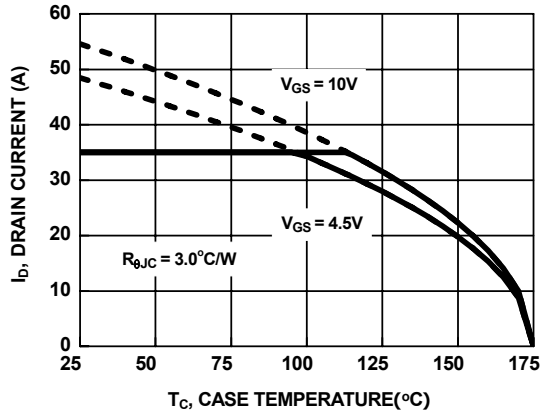

Figure 10. Maximum Continuous Drain Current vs Case Temperature

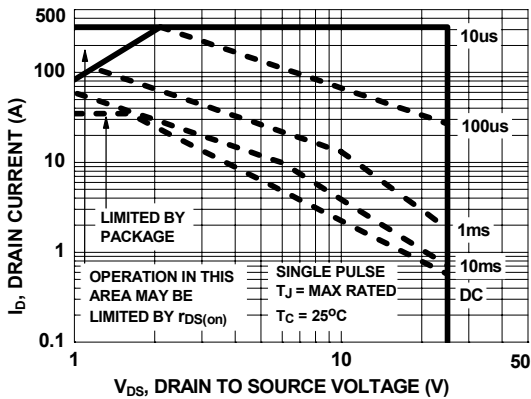

Figure 11. Forward Bias Safe Operating Area

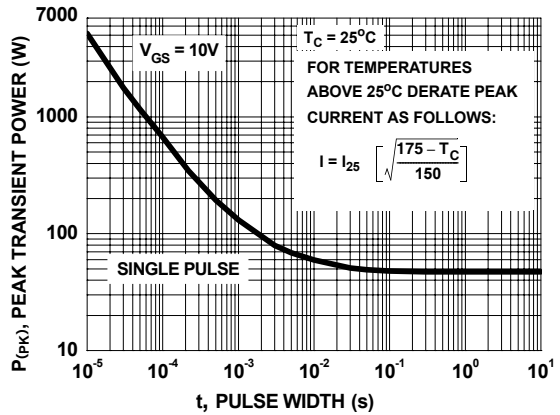

Figure 12. Single Pulse Maximum Power Dissipation

**Typical Characteristics**  $T_J = 25^\circ\text{C}$  unless otherwise noted

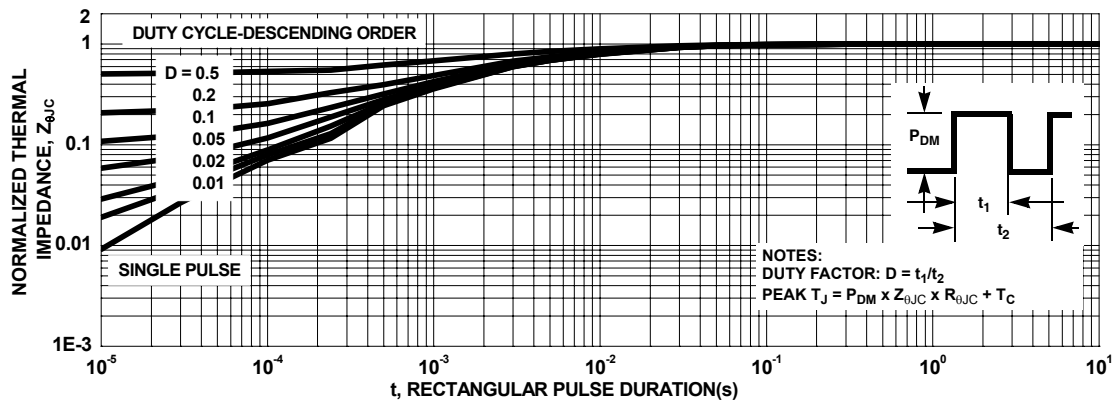

Figure 13. Transient Thermal Response Curve



NOTES: UNLESS OTHERWISE SPECIFIED  
A) THIS PACKAGE CONFORMS TO JEDEC, TO-252, ISSUE C, VARIATION AA.

B) ALL DIMENSIONS ARE IN MILLIMETERS.

C) DIMENSIONING AND TOLERANCING PER ASME Y14.5M-2009.

D) SUPPLIER DEPENDENT MOLD LOCKING HOLES OR CHAMFERED CORNERS OR EDGE PROTRUSION.

E) TRIMMED METAL CENTER LEAD IS PRESENT ON FOR NON-DIODE PRODUCTS

F) DIMENSIONS ARE EXCLUSIVE OF BURS, MOLD FLASH AND TIE BAR EXTRUSIONS.

G) LAND PATTERN RECOMMENDATION IS BASED ON IPC7351A STD TO228P991X239-3N.

H) DRAWING NUMBER AND REVISION: MKT-TO252A03REV11

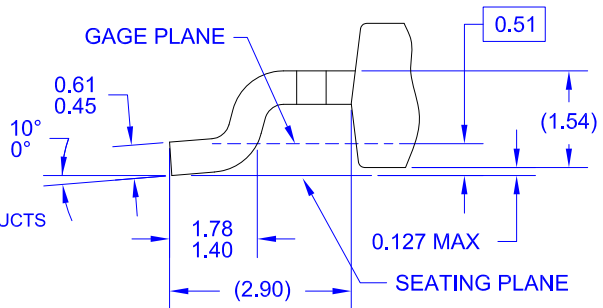



**TRADEMARKS**

The following includes registered and unregistered trademarks and service marks, owned by Fairchild Semiconductor and/or its global subsidiaries, and is not intended to be an exhaustive list of all such trademarks.

- AccuPower™
- AttitudeEngine™
- Awinda®
- AX-CAP®\*
- BitSiC™
- Build it Now™
- CorePLUS™
- CorePOWER™
- CROSSVOL™
- CTL™
- Current Transfer Logic™
- DEUXPEED®
- Dual Cool™
- EcoSPARK®
- EfficientMax™
- ESBC™
- F**™
- Fairchild®
- Fairchild Semiconductor®
- FACT Quiet Series™
- FACT®
- FastvCore™
- FETBench™
- FPS™
- F-PFS™
- FRFET®
- Global Power Resource<sup>SM</sup>
- GreenBridge™
- Green FPS™
- Green FPS™ e-Series™
- Gmax™
- GTO™
- IntelliMAX™
- ISOPLANAR™
- Making Small Speakers Sound Louder and Better™
- MegaBuck™
- MICROCOUPLER™
- MicroFET™
- MicroPak™
- MicroPak2™
- MillerDrive™
- MotionMax™
- MotionGrid®
- MTi®
- MTx®
- MVN®
- mWSaver®
- OptoHiT™
- OPTOLOGIC®
- OPTOPLANAR®
- ™
- Power Supply WebDesigner™
- PowerTrench®
- PowerXS™
- Programmable Active Droop™
- QFET®
- QS™
- Quiet Series™
- RapidConfigure™
- ™
- Saving our world, 1mW/W/kW at a time™
- SignalWise™
- SmartMax™
- SMART START™
- Solutions for Your Success™
- SPM®
- STEALTH™
- SuperFET®
- SuperSOT™-3
- SuperSOT™-6
- SuperSOT™-8
- SupreMOS®
- SyncFET™
- Sync-Lock™
- ™
- TinyBoost®
- TinyBuck®
- TinyCalc™
- TinyLogic®
- TINYOPTO™
- TinyPower™
- TinyPWM™
- TinyWire™
- TranSiC™
- TriFault Detect™
- TRUECURRENT®\*
- μSerDes™
- ™
- UHC®
- Ultra FRFET™
- UniFET™
- VcX™
- VisualMax™
- VoltagePlus™
- XS™
- Xsens™
- 仙童®

\* Trademarks of System General Corporation, used under license by Fairchild Semiconductor.

**DISCLAIMER**

FAIRCHILD SEMICONDUCTOR RESERVES THE RIGHT TO MAKE CHANGES WITHOUT FURTHER NOTICE TO ANY PRODUCTS HEREIN TO IMPROVE RELIABILITY, FUNCTION, OR DESIGN. TO OBTAIN THE LATEST, MOST UP-TO-DATE DATASHEET AND PRODUCT INFORMATION, VISIT OUR WEBSITE AT [HTTP://WWW.FAIRCHILDSEMI.COM](http://www.fairchildsemi.com). FAIRCHILD DOES NOT ASSUME ANY LIABILITY ARISING OUT OF THE APPLICATION OR USE OF ANY PRODUCT OR CIRCUIT DESCRIBED HEREIN; NEITHER DOES IT CONVEY ANY LICENSE UNDER ITS PATENT RIGHTS, NOR THE RIGHTS OF OTHERS. THESE SPECIFICATIONS DO NOT EXPAND THE TERMS OF FAIRCHILD'S WORLDWIDE TERMS AND CONDITIONS, SPECIFICALLY THE WARRANTY THEREIN, WHICH COVERS THESE PRODUCTS.

**AUTHORIZED USE**

Unless otherwise specified in this data sheet, this product is a standard commercial product and is not intended for use in applications that require extraordinary levels of quality and reliability. This product may not be used in the following applications, unless specifically approved in writing by a Fairchild officer: (1) automotive or other transportation, (2) military/aerospace, (3) any safety critical application – including life critical medical equipment – where the failure of the Fairchild product reasonably would be expected to result in personal injury, death or property damage. Customer's use of this product is subject to agreement of this Authorized Use policy. In the event of an unauthorized use of Fairchild's product, Fairchild accepts no liability in the event of product failure. In other respects, this product shall be subject to Fairchild's Worldwide Terms and Conditions of Sale, unless a separate agreement has been signed by both Parties.

**ANTI-COUNTERFEITING POLICY**

Fairchild Semiconductor Corporation's Anti-Counterfeiting Policy. Fairchild's Anti-Counterfeiting Policy is also stated on our external website, [www.fairchildsemi.com](http://www.fairchildsemi.com), under Terms of Use

Counterfeiting of semiconductor parts is a growing problem in the industry. All manufacturers of semiconductor products are experiencing counterfeiting of their parts. Customers who inadvertently purchase counterfeit parts experience many problems such as loss of brand reputation, substandard performance, failed applications, and increased cost of production and manufacturing delays. Fairchild is taking strong measures to protect ourselves and our customers from the proliferation of counterfeit parts. Fairchild strongly encourages customers to purchase Fairchild parts either directly from Fairchild or from Authorized Fairchild Distributors who are listed by country on our web page cited above. Products customers buy either from Fairchild directly or from Authorized Fairchild Distributors are genuine parts, have full traceability, meet Fairchild's quality standards for handling and storage and provide access to Fairchild's full range of up-to-date technical and product information. Fairchild and our Authorized Distributors will stand behind all warranties and will appropriately address any warranty issues that may arise. Fairchild will not provide any warranty coverage or other assistance for parts bought from Unauthorized Sources. Fairchild is committed to combat this global problem and encourage our customers to do their part in stopping this practice by buying direct or from authorized distributors.

**PRODUCT STATUS DEFINITIONS**

**Definition of Terms**

Datasheet Identification	Product Status	Definition
Advance Information	Formative / In Design	Datasheet contains the design specifications for product development. Specifications may change in any manner without notice.
Preliminary	First Production	Datasheet contains preliminary data; supplementary data will be published at a later date. Fairchild Semiconductor reserves the right to make changes at any time without notice to improve design.
No Identification Needed	Full Production	Datasheet contains final specifications. Fairchild Semiconductor reserves the right to make changes at any time without notice to improve the design.
Obsolete	Not In Production	Datasheet contains specifications on a product that is discontinued by Fairchild Semiconductor. The datasheet is for reference information only.

Rev. I77

# Mouser Electronics

Authorized Distributor

Click to View Pricing, Inventory, Delivery & Lifecycle Information:

[Fairchild Semiconductor:](#)

[FDD8782](#)