

FDP7N60NZ / FDPF7N60NZ

N-Channel UniFET™ II MOSFET

600 V, 6.5 A, 1.25 Ω

Features

- $R_{DS(on)} = 1.05 \Omega$ (Typ.) @ $V_{GS} = 10 V, I_D = 3.25 A$
- Low Gate Charge (Typ. 13 nC)
- Low C_{rss} (Typ. 7 pF)
- 100% Avalanche Tested
- Improved dv/dt Capability
- ESD Improved Capability
- RoHS Compliant

Applications

- LCD/ LED/ PDP TV
- Lighting
- Uninterruptible Power Supply
- AC-DC Power Supply

Description

UniFET™ II MOSFET is Fairchild Semiconductor's high voltage MOSFET family based on advanced planar stripe and DMOS technology. This advanced MOSFET family has the smallest on-state resistance among the planar MOSFET, and also provides superior switching performance and higher avalanche energy strength. In addition, internal gate-source ESD diode allows UniFET II MOSFET to withstand over 2kV HBM surge stress. This device family is suitable for switching power converter applications such as power factor correction (PFC), flat panel display (FPD) TV power, ATX and electronic lamp ballasts.

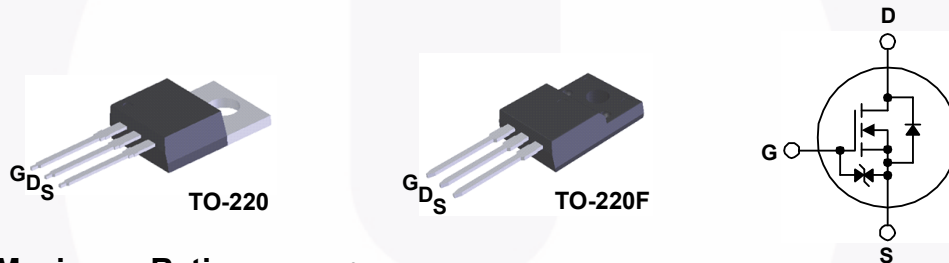

MOSFET Maximum Ratings $T_C = 25^\circ C$ unless otherwise noted.

| Symbol | Parameter | FDP7N60NZ | FDPF7N60NZ / FDPF7N60NZT | Unit |
|----------------|--|--------------------------------------|--------------------------|------------|
| V_{DSS} | Drain to Source Voltage | 600 | | V |
| V_{GSS} | Gate to Source Voltage | ±30 | | V |
| I_D | Drain Current | - Continuous ($T_C = 25^\circ C$) | 6.5 | 6.5* |
| | | - Continuous ($T_C = 100^\circ C$) | 3.9 | 3.9* |
| I_{DM} | Drain Current | - Pulsed (Note 1) | 26 | 26* |
| E_{AS} | Single Pulsed Avalanche Energy (Note 2) | 275 | | mJ |
| I_{AR} | Avalanche Current (Note 1) | 6.5 | | A |
| E_{AR} | Repetitive Avalanche Energy (Note 1) | 14.7 | | mJ |
| dv/dt | Peak Diode Recovery dv/dt (Note 3) | 10 | | V/ns |
| P_D | Power Dissipation | ($T_C = 25^\circ C$) | 147 | 33 |
| | | - Derate Above $25^\circ C$ | 1.2 | 0.26 |
| T_J, T_{STG} | Operating and Storage Temperature Range | -55 to +150 | | $^\circ C$ |
| T_L | Maximum Lead Temperature for Soldering, 1/8" from Case for 5 Seconds | 300 | | $^\circ C$ |

*Drain current limited by maximum junction temperature.

Thermal Characteristics

| Symbol | Parameter | FDP7N60NZ | FDPF7N60NZ / FDPF7N60NZT | Unit |
|-----------------|---|-----------|--------------------------|--------------|
| $R_{\theta JC}$ | Thermal Resistance, Junction to Case, Max. | 0.85 | 3.8 | $^\circ C/W$ |
| $R_{\theta JA}$ | Thermal Resistance, Junction to Ambient, Max. | 62.5 | 62.5 | |

Package Marking and Ordering Information

| Part Number | Top Mark | Package | Packing Method | Reel Size | Tape Width | Quantity |
|-------------|------------|---------|----------------|-----------|------------|----------|
| FDP7N60NZ | FDP7N60NZ | TO-220 | Tube | N/A | N/A | 50 units |
| FDPF7N60NZ | FDPF7N60NZ | TO-220F | Tube | N/A | N/A | 50 units |
| FDPF7N60NZT | FDPF7N60NZ | TO-220F | Tube | N/A | N/A | 50 units |

Electrical Characteristics $T_C = 25^\circ\text{C}$ unless otherwise noted.

| Symbol | Parameter | Test Conditions | Min. | Typ. | Max. | Unit |
|--------|-----------|-----------------|------|------|------|------|
|--------|-----------|-----------------|------|------|------|------|

Off Characteristics

| | | | | | | |
|--------------------------------|---|---|-----|-----|----------|---------------------------|
| BV_{DSS} | Drain to Source Breakdown Voltage | $I_D = 250 \mu\text{A}$, $V_{GS} = 0 \text{ V}$, $T_J = 25^\circ\text{C}$ | 600 | - | - | V |
| $\Delta BV_{DSS} / \Delta T_J$ | Breakdown Voltage Temperature Coefficient | $I_D = 250 \mu\text{A}$, Referenced to 25°C | - | 0.6 | - | $\text{V}/^\circ\text{C}$ |
| I_{DSS} | Zero Gate Voltage Drain Current | $V_{DS} = 600 \text{ V}$, $V_{GS} = 0 \text{ V}$ | - | - | 1 | μA |
| | | $V_{DS} = 480 \text{ V}$, $T_C = 125^\circ\text{C}$ | - | - | 10 | |
| I_{GSS} | Gate to Body Leakage Current | $V_{GS} = \pm 25 \text{ V}$, $V_{DS} = 0 \text{ V}$ | - | - | ± 10 | μA |

On Characteristics

| | | | | | | |
|--------------|--------------------------------------|--|---|------|------|----------|
| $V_{GS(th)}$ | Gate Threshold Voltage | $V_{GS} = V_{DS}$, $I_D = 250 \mu\text{A}$ | 3 | - | 5 | V |
| $R_{DS(on)}$ | Static Drain to Source On Resistance | $V_{GS} = 10 \text{ V}$, $I_D = 3.25 \text{ A}$ | - | 1.05 | 1.25 | Ω |
| g_{FS} | Forward Transconductance | $V_{DS} = 20 \text{ V}$, $I_D = 3.25 \text{ A}$ | - | 7.3 | - | S |

Dynamic Characteristics

| | | | | | | |
|--------------|-------------------------------|---|----------|-----|-----|----|
| C_{iss} | Input Capacitance | $V_{DS} = 25 \text{ V}$, $V_{GS} = 0 \text{ V}$, $f = 1 \text{ MHz}$ | - | 550 | 730 | pF |
| C_{oss} | Output Capacitance | | - | 70 | 90 | pF |
| C_{rss} | Reverse Transfer Capacitance | | - | 7 | 10 | pF |
| $Q_{g(tot)}$ | Total Gate Charge at 10V | $V_{DS} = 480 \text{ V}$, $I_D = 6.5 \text{ A}$, $V_{GS} = 10 \text{ V}$ | - | 13 | 17 | nC |
| Q_{gs} | Gate to Source Gate Charge | | - | 3 | - | nC |
| Q_{gd} | Gate to Drain "Miller" Charge | | (Note 4) | - | 5.6 | - |

Switching Characteristics

| | | | | | | |
|--------------|---------------------|---|----------|------|----|----|
| $t_{d(on)}$ | Turn-On Delay Time | $V_{DD} = 300 \text{ V}$, $I_D = 6.5 \text{ A}$, $V_{GS} = 10 \text{ V}$, $R_G = 25 \Omega$ | - | 17.5 | 45 | ns |
| t_r | Turn-On Rise Time | | - | 30 | 70 | ns |
| $t_{d(off)}$ | Turn-Off Delay Time | | - | 40 | 90 | ns |
| t_f | Turn-Off Fall Time | | (Note 4) | - | 25 | 60 |

Drain-Source Diode Characteristics

| | | | | | | |
|----------|--|--|---|-----|-----|---------------|
| I_S | Maximum Continuous Drain to Source Diode Forward Current | - | - | 6.5 | A | |
| I_{SM} | Maximum Pulsed Drain to Source Diode Forward Current | - | - | 26 | A | |
| V_{SD} | Drain to Source Diode Forward Voltage | $V_{GS} = 0 \text{ V}$, $I_{SD} = 6.5 \text{ A}$ | - | - | 1.4 | V |
| t_{rr} | Reverse Recovery Time | $V_{GS} = 0 \text{ V}$, $I_{SD} = 6.5 \text{ A}$, $di_F/dt = 100 \text{ A}/\mu\text{s}$ | - | 250 | - | ns |
| Q_{rr} | Reverse Recovery Charge | | - | 1.4 | - | μC |

Notes:

- 1: Repetitive rating: pulse-width limited by maximum junction temperature.
- 2: $L = 13 \text{ mH}$, $I_{AS} = 6.5 \text{ A}$, $V_{DD} = 50 \text{ V}$, $R_G = 25 \Omega$, starting $T_J = 25^\circ\text{C}$.
- 3: $I_{SD} \leq 6.5 \text{ A}$, $di/dt \leq 200 \text{ A}/\mu\text{s}$, $V_{DD} \leq BV_{DSS}$, starting $T_J = 25^\circ\text{C}$.
- 4: Essentially independent of operating temperature typical characteristics.

Typical Performance Characteristics

Figure 1. On-Region Characteristics

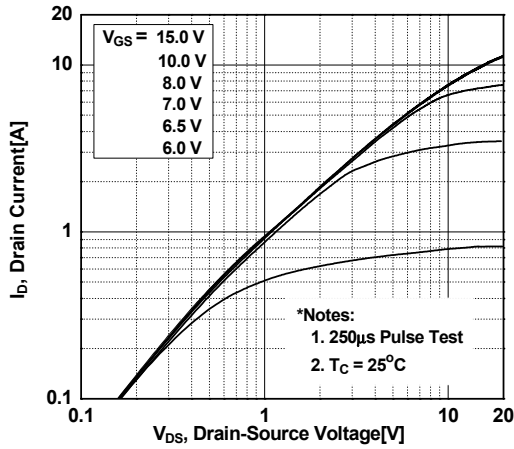

Figure 2. Transfer Characteristics

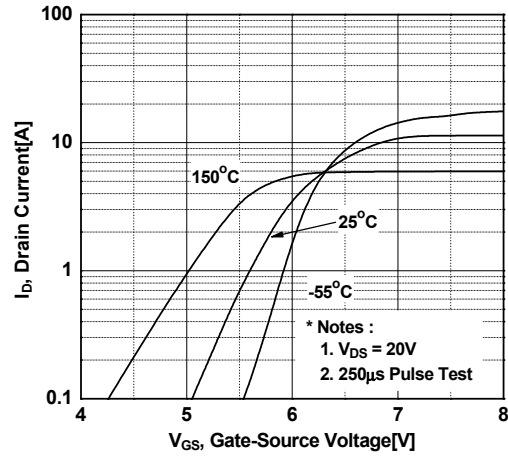

Figure 3. On-Resistance Variation vs. Drain Current and Gate Voltage

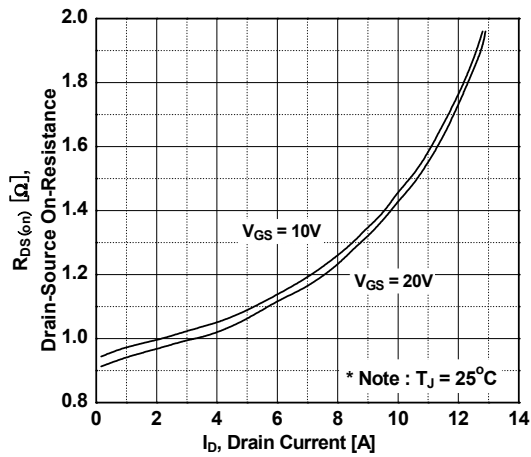

Figure 4. Body Diode Forward Voltage Variation vs. Source Current and Temperature

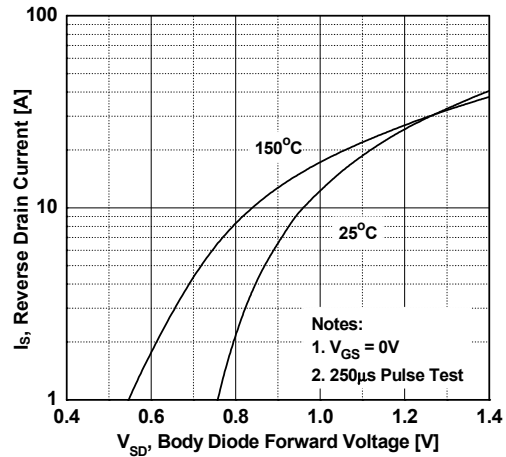

Figure 5. Capacitance Characteristics

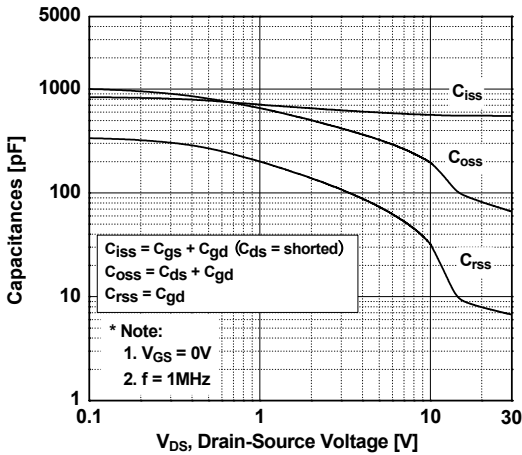
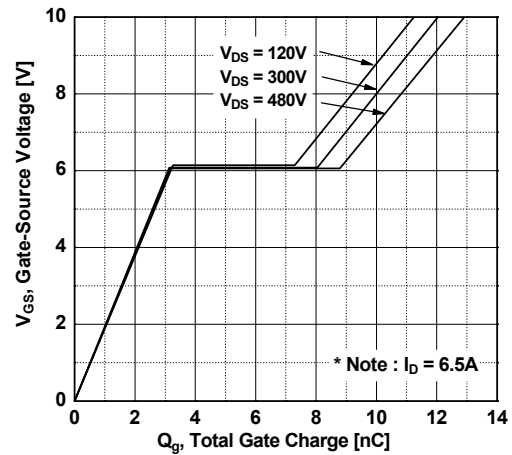

Figure 6. Gate Charge Characteristics



Typical Performance Characteristics (Continued)

Figure 7. Breakdown Voltage Variation vs. Temperature

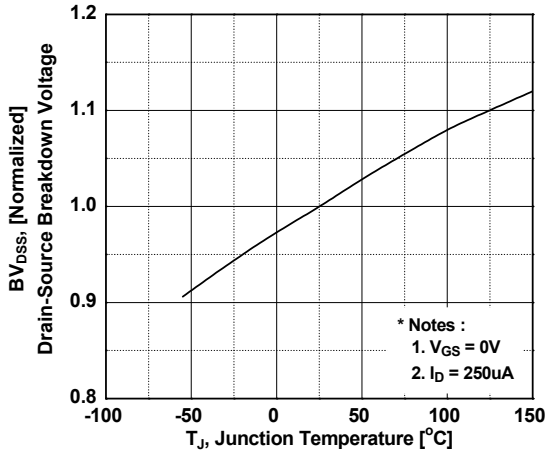

Figure 8. On-Resistance Variation vs Temperature

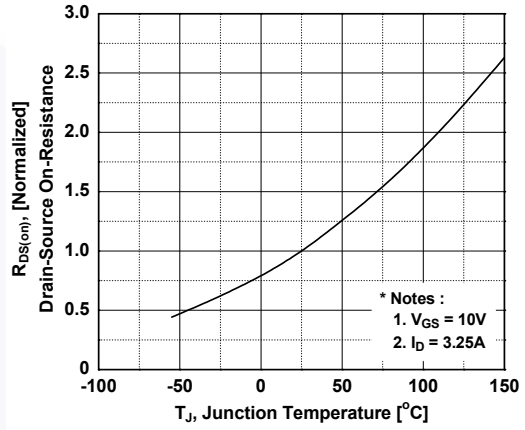

Figure 9. Maximum Safe Operating Area - FDPF7N60NZ / FDPF7N60NZT

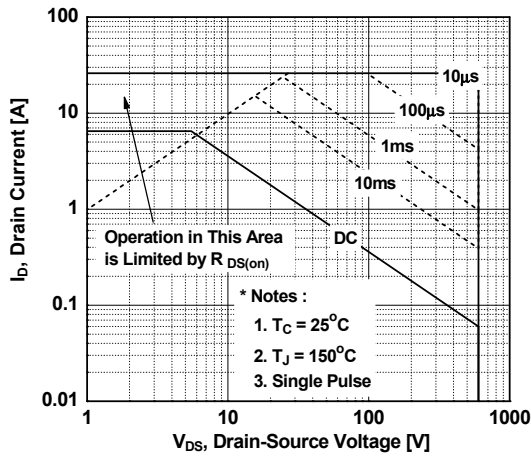

Figure 10. Maximum Safe Operating Area - FDP7N60NZ

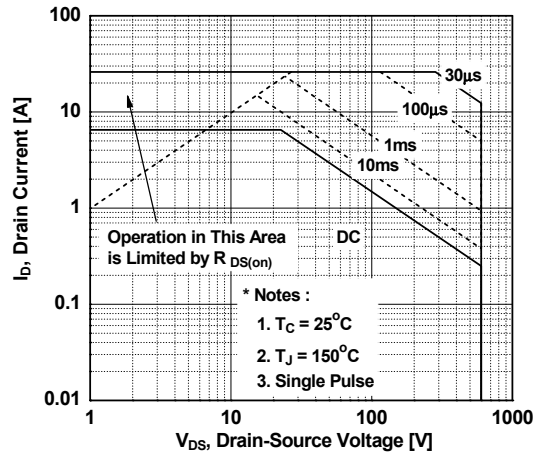
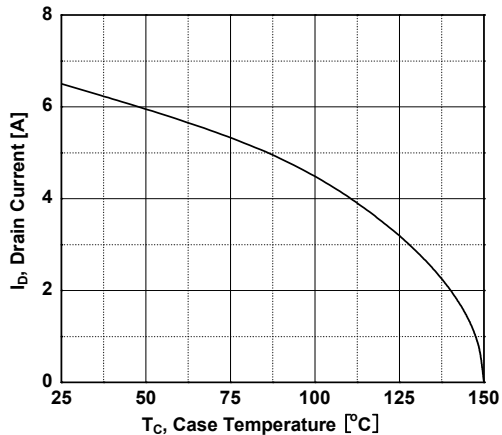

Figure 11. Maximum Drain Current vs. Case Temperature



Typical Performance Characteristics (Continued)

Figure 12. Transient Thermal Response Curve
- FDPF7N60NZ / FDPF7N60NZT

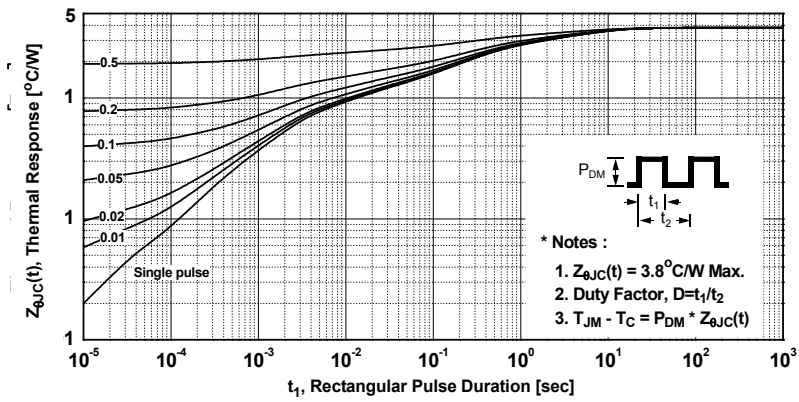

Figure 13. Transient Thermal Response Curve
- FDP7N60NZ

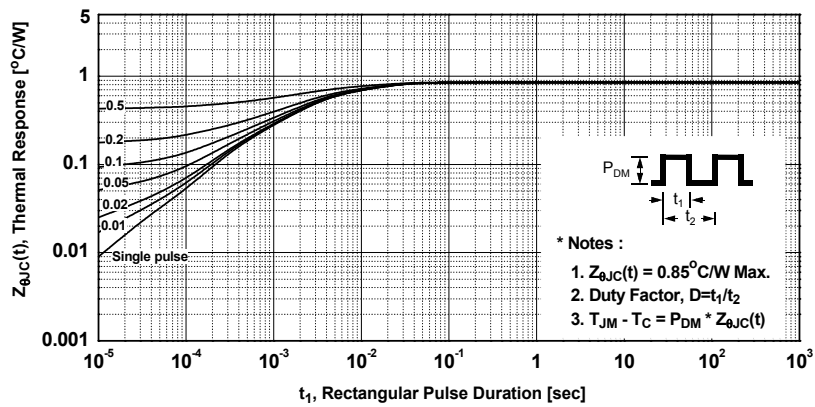



Figure 14. Gate Charge Test Circuit & Waveform



Figure 15. Resistive Switching Test Circuit & Waveforms



Figure 16. Unclamped Inductive Switching Test Circuit & Waveforms



Figure 17. Peak Diode Recovery dv/dt Test Circuit & Waveforms



- NOTES:
- A) REFERENCE JEDEC, TO-220, VARIATION AB
 - B) ALL DIMENSIONS ARE IN MILLIMETERS.
 - C) DIMENSIONS COMMON TO ALL PACKAGE SUPPLIERS EXCEPT WHERE NOTED [].
 - D) LOCATION OF MOLDED FEATURE MAY VARY (LOWER LEFT CORNER, LOWER CENTER AND CENTER OF THE PACKAGE)
 - E) DOES NOT COMPLY JEDEC STANDARD VALUE.
 - F) "A1" DIMENSIONS AS BELOW:
 SINGLE GAUGE = 0.51 - 0.61
 DUAL GAUGE = 1.10 - 1.45
 - G) DRAWING FILE NAME: TO220B03REV9
 - H) PRESENCE IS SUPPLIER DEPENDENT
 - I) SUPPLIER DEPENDENT MOLD LOCKING HOLES IN HEATSINK.

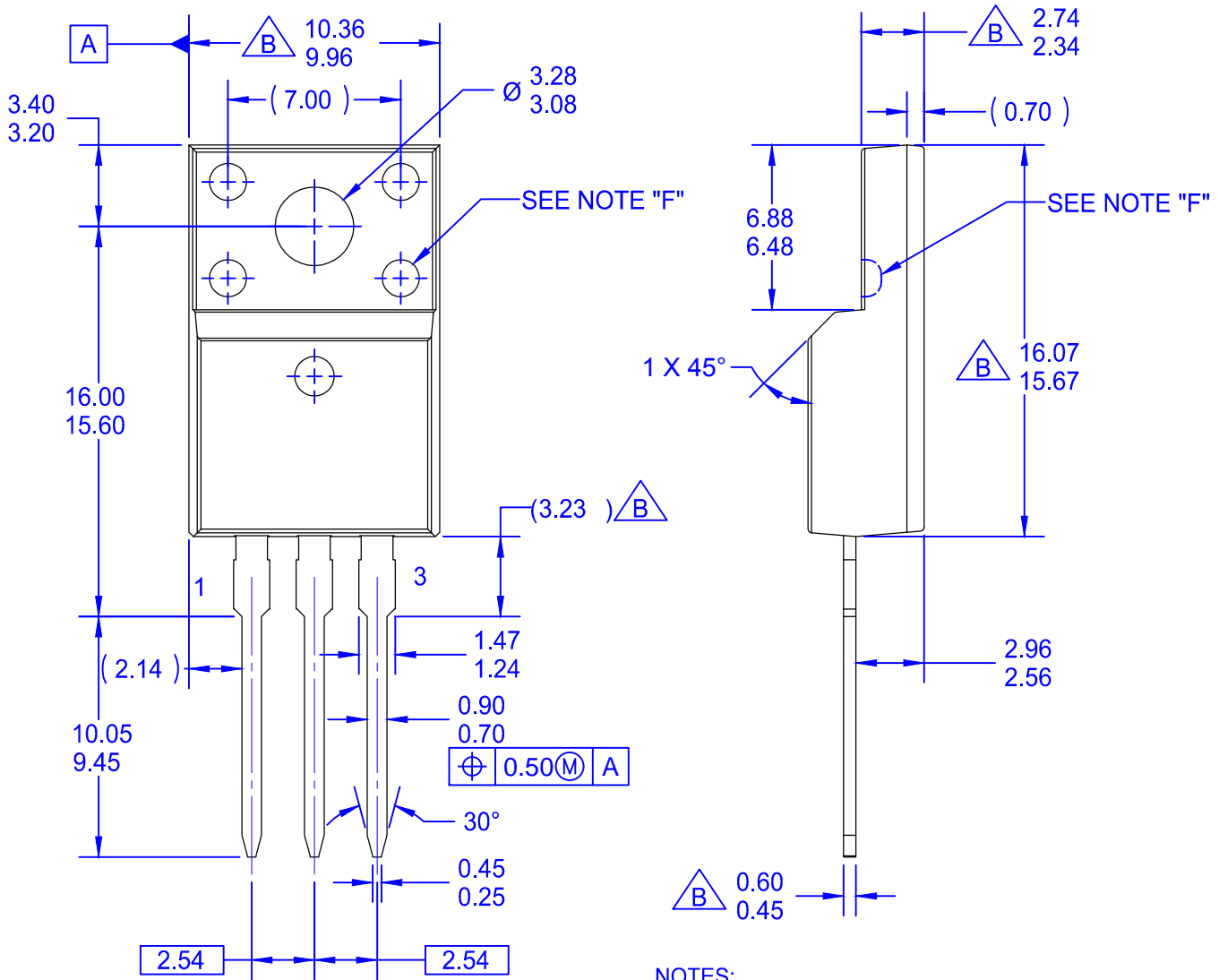

$\text{M} \begin{matrix} \oplus \\ \ominus \end{matrix} 0.50 \text{ (M) } A$

NOTES:

- A. EXCEPT WHERE NOTED CONFORMS TO EIAJ SC91A.
- B. DOES NOT COMPLY EIAJ STD. VALUE.
- C. ALL DIMENSIONS ARE IN MILLIMETERS.
- D. DIMENSIONS ARE EXCLUSIVE OF BURRS, MOLD FLASH AND TIE BAR PROTRUSIONS.
- E. DIMENSION AND TOLERANCE AS PER ASME Y14.5-1994.
- F. OPTION 1 - WITH SUPPORT PIN HOLE.
OPTION 2 - NO SUPPORT PIN HOLE.
- G. DRAWING FILE NAME: TO220M03REV4





TRADEMARKS

The following includes registered and unregistered trademarks and service marks, owned by Fairchild Semiconductor and/or its global subsidiaries, and is not intended to be an exhaustive list of all such trademarks.

- AccuPower™
- AttitudeEngine™
- Awinda®
- AX-CAP®*
- BitSiC™
- Build it Now™
- CorePLUS™
- CorePOWER™
- CROSSVOL™
- CTL™
- Current Transfer Logic™
- DEUXPEED®
- Dual Cool™
- EcoSPARK®
- EfficientMax™
- ESBC™
- F**™
- Fairchild®
- Fairchild Semiconductor®
- FACT Quiet Series™
- FACT®
- FastvCore™
- FETBench™
- FPS™
- F-PFS™
- FRFET®
- Global Power ResourceSM
- GreenBridge™
- Green FPS™
- Green FPS™ e-Series™
- Gmax™
- GTO™
- IntelliMAX™
- ISOPLANAR™
- Making Small Speakers Sound Louder and Better™
- MegaBuck™
- MICROCOUPLER™
- MicroFET™
- MicroPak™
- MicroPak2™
- MillerDrive™
- MotionMax™
- MotionGrid®
- MTi®
- MTx®
- MVN®
- mWSaver®
- OptoHiT™
- OPTOLOGIC®
- OPTOPLANAR®
- ®
- Power Supply WebDesigner™
- PowerTrench®
- PowerXS™
- Programmable Active Droop™
- QFET®
- QS™
- Quiet Series™
- RapidConfigure™
- ™
- Saving our world, 1mW/W/kW at a time™
- SignalWise™
- SmartMax™
- SMART START™
- Solutions for Your Success™
- SPM®
- STEALTH™
- SuperFET®
- SuperSOT™-3
- SuperSOT™-6
- SuperSOT™-8
- SupreMOS®
- SyncFET™
- Sync-Lock™
- ®
- TinyBoost®
- TinyBuck®
- TinyCalc™
- TinyLogic®
- TINYOPTO™
- TinyPower™
- TinyPWM™
- TinyWire™
- TranSiC™
- TriFault Detect™
- TRUECURRENT®*
- μSerDes™
- ™
- UHC®
- Ultra FRFET™
- UniFET™
- VcX™
- VisualMax™
- VoltagePlus™
- XS™
- Xsens™
- 仙童®

* Trademarks of System General Corporation, used under license by Fairchild Semiconductor.

DISCLAIMER

FAIRCHILD SEMICONDUCTOR RESERVES THE RIGHT TO MAKE CHANGES WITHOUT FURTHER NOTICE TO ANY PRODUCTS HEREIN TO IMPROVE RELIABILITY, FUNCTION, OR DESIGN. TO OBTAIN THE LATEST, MOST UP-TO-DATE DATASHEET AND PRODUCT INFORMATION, VISIT OUR WEBSITE AT [HTTP://WWW.FAIRCHILDSEMI.COM](http://www.fairchildsemi.com). FAIRCHILD DOES NOT ASSUME ANY LIABILITY ARISING OUT OF THE APPLICATION OR USE OF ANY PRODUCT OR CIRCUIT DESCRIBED HEREIN; NEITHER DOES IT CONVEY ANY LICENSE UNDER ITS PATENT RIGHTS, NOR THE RIGHTS OF OTHERS. THESE SPECIFICATIONS DO NOT EXPAND THE TERMS OF FAIRCHILD'S WORLDWIDE TERMS AND CONDITIONS, SPECIFICALLY THE WARRANTY THEREIN, WHICH COVERS THESE PRODUCTS.

AUTHORIZED USE

Unless otherwise specified in this data sheet, this product is a standard commercial product and is not intended for use in applications that require extraordinary levels of quality and reliability. This product may not be used in the following applications, unless specifically approved in writing by a Fairchild officer: (1) automotive or other transportation, (2) military/aerospace, (3) any safety critical application – including life critical medical equipment – where the failure of the Fairchild product reasonably would be expected to result in personal injury, death or property damage. Customer's use of this product is subject to agreement of this Authorized Use policy. In the event of an unauthorized use of Fairchild's product, Fairchild accepts no liability in the event of product failure. In other respects, this product shall be subject to Fairchild's Worldwide Terms and Conditions of Sale, unless a separate agreement has been signed by both Parties.

ANTI-COUNTERFEITING POLICY

Fairchild Semiconductor Corporation's Anti-Counterfeiting Policy. Fairchild's Anti-Counterfeiting Policy is also stated on our external website, www.fairchildsemi.com, under Terms of Use

Counterfeiting of semiconductor parts is a growing problem in the industry. All manufacturers of semiconductor products are experiencing counterfeiting of their parts. Customers who inadvertently purchase counterfeit parts experience many problems such as loss of brand reputation, substandard performance, failed applications, and increased cost of production and manufacturing delays. Fairchild is taking strong measures to protect ourselves and our customers from the proliferation of counterfeit parts. Fairchild strongly encourages customers to purchase Fairchild parts either directly from Fairchild or from Authorized Fairchild Distributors who are listed by country on our web page cited above. Products customers buy either from Fairchild directly or from Authorized Fairchild Distributors are genuine parts, have full traceability, meet Fairchild's quality standards for handling and storage and provide access to Fairchild's full range of up-to-date technical and product information. Fairchild and our Authorized Distributors will stand behind all warranties and will appropriately address any warranty issues that may arise. Fairchild will not provide any warranty coverage or other assistance for parts bought from Unauthorized Sources. Fairchild is committed to combat this global problem and encourage our customers to do their part in stopping this practice by buying direct or from authorized distributors.

PRODUCT STATUS DEFINITIONS

Definition of Terms

| Datasheet Identification | Product Status | Definition |
|--------------------------|-----------------------|---|
| Advance Information | Formative / In Design | Datasheet contains the design specifications for product development. Specifications may change in any manner without notice. |
| Preliminary | First Production | Datasheet contains preliminary data; supplementary data will be published at a later date. Fairchild Semiconductor reserves the right to make changes at any time without notice to improve design. |
| No Identification Needed | Full Production | Datasheet contains final specifications. Fairchild Semiconductor reserves the right to make changes at any time without notice to improve the design. |
| Obsolete | Not In Production | Datasheet contains specifications on a product that is discontinued by Fairchild Semiconductor. The datasheet is for reference information only. |

Rev. I77

Mouser Electronics

Authorized Distributor

Click to View Pricing, Inventory, Delivery & Lifecycle Information:

[Fairchild Semiconductor:](#)

[FDP7N60NZ](#)