



Is Now Part of



ON Semiconductor®

To learn more about ON Semiconductor, please visit our website at
www.onsemi.com

ON Semiconductor and the ON Semiconductor logo are trademarks of Semiconductor Components Industries, LLC dba ON Semiconductor or its subsidiaries in the United States and/or other countries. ON Semiconductor owns the rights to a number of patents, trademarks, copyrights, trade secrets, and other intellectual property. A listing of ON Semiconductor's product/patent coverage may be accessed at www.onsemi.com/site/pdf/Patent-Marking.pdf. ON Semiconductor reserves the right to make changes without further notice to any products herein. ON Semiconductor makes no warranty, representation or guarantee regarding the suitability of its products for any particular purpose, nor does ON Semiconductor assume any liability arising out of the application or use of any product or circuit, and specifically disclaims any and all liability, including without limitation special, consequential or incidental damages. Buyer is responsible for its products and applications using ON Semiconductor products, including compliance with all laws, regulations and safety requirements or standards, regardless of any support or applications information provided by ON Semiconductor. "Typical" parameters which may be provided in ON Semiconductor data sheets and/or specifications can and do vary in different applications and actual performance may vary over time. All operating parameters, including "Typicals" must be validated for each customer application by customer's technical experts. ON Semiconductor does not convey any license under its patent rights nor the rights of others. ON Semiconductor products are not designed, intended, or authorized for use as a critical component in life support systems or any FDA Class 3 medical devices or medical devices with a same or similar classification in a foreign jurisdiction or any devices intended for implantation in the human body. Should Buyer purchase or use ON Semiconductor products for any such unintended or unauthorized application, Buyer shall indemnify and hold ON Semiconductor and its officers, employees, subsidiaries, affiliates, and distributors harmless against all claims, costs, damages, and expenses, and reasonable attorney fees arising out of, directly or indirectly, any claim of personal injury or death associated with such unintended or unauthorized use, even if such claim alleges that ON Semiconductor was negligent regarding the design or manufacture of the part. ON Semiconductor is an Equal Opportunity/Affirmative Action Employer. This literature is subject to all applicable copyright laws and is not for resale in any manner.

FOD0721, FOD0720, FOD0710

High CMR, 25Mbit/sec Logic Gate Optocoupler

Features

- 20kV/μs minimum CMR
- 40ns max. propagation delay
- Data Rate, Non-Return Zero Coding
 - 25Mbit/sec (FOD0721 and FOD0720)
 - 12.5Mbit/sec (FOD0710)
- Pulse Width Distortion
 - 6ns (FOD0721)
 - 8ns (FOD0720 and FOD0710)
- +5V CMOS compatibility
- Extended industrial temperature range
 - -40 to 100°C temperature range
- Safety and regulatory approvals
 - UL1577, 3750 VACrms for 1 min. (File #E90700, Volume 2)
 - IEC60747-5-2 pending approval

Description

The FOD0721/0720/0710 family utilizes Fairchild's proprietary coplanar packaging technology, Optoplanar®, and optimized IC design to guarantee minimum 20kV/μs Common Mode Noise Rejection (CMR) rating.

These high-speed logic gate optocouplers consist of a high-speed AlGaAs LED driven by a CMOS IC coupled to a CMOS detector IC, comprising an integrated photodiode, a high-speed transimpedance amplifier and a voltage comparator with an output driver. The CMOS technology coupled to the high efficiency of the LED achieves low power consumption as well as very high speed (40ns propagation delay, 6ns pulse width distortion).

These devices are available in a compact 8-pin small outline package.

Applications

- Industrial fieldbus communications
 - Profibus, DeviceNet, CAN, RS485
- Programmable logic control
- Isolated data acquisition system

Functional Schematic

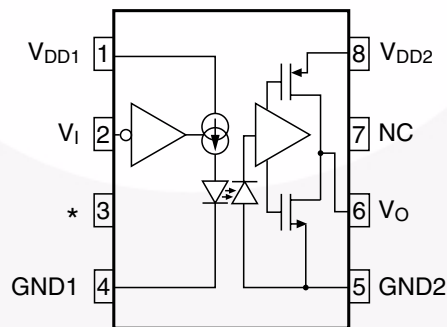

*: Pin 3 must be left unconnected

Truth Table

V _I	LED	V _O
H	OFF	H
L	ON	L

Pin Definitions

Pin Number	Pin Name	Pin Function Description
1	V _{DD1}	Input Supply Voltage
2	V _I	Input Data
3		LED Anode – must be left unconnected
4	GND1	Input Ground
5	GND2	Output Ground
6	V _O	Output Data
7	NC	Not Connected
8	V _{DD2}	Output Supply Voltage

Absolute Maximum Ratings (T_A = 25°C unless otherwise specified.)

Stresses exceeding the absolute maximum ratings may damage the device. The device may not function or be operable above the recommended operating conditions and stressing the parts to these levels is not recommended. In addition, extended exposure to stresses above the recommended operating conditions may affect device reliability. The absolute maximum ratings are stress ratings only.

Symbol	Parameter	Value	Units
T _{STG}	Storage Temperature	-40 to +125	°C
T _{OPR}	Operating Temperature	-40 to +100	°C
T _{SOL}	Lead Solder Temperature	260 for 10 sec	°C
	Reflow Temperature Profile (Refer to Relow Profile)		
V _{DD1}	Input Supply Voltage	0 to 6.0	V
V _I	Input Voltage	-0.5 to V _{DD1} + 0.5	V
I _I	Input DC Current	-10 to +10	mA
V _{DD2}	Output Supply Voltage	0 to 6.0	V
V _D	Output Voltage	-0.5 to V _{DD2} + 0.5	V
I _O	Average Output Current	10	mA
PD1	Input Power Dissipation	90	mW
PD2	Output Power Dissipation	70	mW

Recommended Operating Conditions

The Recommended Operating Conditions table defines the conditions for actual device operation. Recommended operating conditions are specified to ensure optimal performance to the datasheet specifications. Fairchild does not recommend exceeding them or designing to absolute maximum ratings.

Symbol	Parameter	Min.	Max.	Unit
T _{OPR}	Ambient Operating Temperature	-40	+100	°C
V _{DD1} , V _{DD2}	Supply Voltages	4.5	5.5	V
V _{IH}	Logic High Input Voltage	2.0	V _{DD1}	V
V _{IL}	Logic Low Input Voltage	0	0.8	V
t _r , t _f	Input Signal Rise and Fall Time		1.0	ms

- A 0.1μF bypass capacitor must be connected between pins 1 and 4, and 5 and 8
- Pin 3 must be left unconnected

Electrical Characteristics ($T_A = -40^\circ\text{C}$ to 100°C and $4.5\text{V} \leq V_{DD} \leq 5.5\text{V}$, all typicals are at $T_A = 25^\circ\text{C}$, $V_{DD} = 5\text{V}$)

Symbol	Parameter	Test Conditions	Min.	Typ.	Max.	Unit
INPUT CHARACTERISTICS						
I_{DD1L}	Logic Low Input Supply Current	$V_I = 0\text{V}$		6.5	10.0	mA
I_{DD1H}	Logic High Input Supply Current	$V_I = V_{DD1}$		0.8	3.0	mA
I_{DD1}	Input Supply Current				13.0	mA
I_I	Input Current		-10		+10	μA
OUTPUT CHARACTERISTICS						
I_{DD2L}	Logic Low Output Supply Current	$V_I = 0\text{V}$		5.5	9	mA
I_{DD2H}	Logic High Output Supply Current	$V_I = V_{DD1}$		5.3	9	mA
V_{OH}	Logic High Output Voltage	$I_O = -20\mu\text{A}$, $V_I = V_{IH}$	4.4	5.0		V
V_{OH}		$I_O = -4\text{mA}$, $V_I = V_{IH}$	4.0	4.8		V
V_{OL}	Logic Low Output Voltage	$I_O = 20\mu\text{A}$, $V_I = V_{IL}$		0	0.1	V
V_{OL}		$I_O = 4\text{mA}$, $V_I = V_{IL}$		0.5	1.0	V

Isolation Characteristics ($T_A = -40^\circ\text{C}$ to $+100^\circ\text{C}$ unless otherwise specified.)

Symbol	Characteristics	Test Conditions	Min.	Typ.*	Max.	Unit
V_{ISO}	Input-Output Isolation Voltage	$f = 60\text{Hz}$, $t = 1.0\text{ min}$, $I_{I-O} \leq 10\mu\text{A}^{(1)(2)}$	3750			V_{aCRMS}
R_{ISO}	Isolation Resistance	$V_{I-O} = 500\text{V}^{(1)}$	10^{11}			Ω
C_{ISO}	Isolation Capacitance	$V_{I-O} = 0$, $f = 1.0\text{MHz}^{(1)}$		0.2		pF

*All typicals at $T_A = 25^\circ\text{C}$ **Notes:**

- Device is considered a two terminal device: Pins 1, 2, 3 and 4 are shorted together and Pins 5, 6, 7 and 8 are shorted together.
- 3,750 VAC RMS for 1 minute duration is equivalent to 4,500 VAC RMS for 1 second duration.

Switching Characteristics ($T_A = -40^\circ\text{C}$ to 100°C and $4.5\text{V} \leq V_{DD} \leq 5.5\text{V}$, all typicals are at $T_A = 25^\circ\text{C}$, $V_{DD} = 5\text{V}$)

Symbol	Parameter	Test Conditions	Min.	Typ.	Max.	Unit
t_{PHL}	Propagation Delay Time to Logic Low Output	$C_L = 15\text{pF}$		21	40	ns
t_{PLH}	Propagation Delay Time to Logic High Output	$C_L = 15\text{pF}$		23	40	ns
PWD	Pulse Width Distortion, $ t_{PHL} - t_{PLH} $					
	FOD0710	$PW = 80\text{ns}$, $C_L = 15\text{pF}$		2	8	ns
	FOD0720	$PW = 40\text{ns}$, $C_L = 15\text{pF}$		2	8	ns
	FOD0721	$PW = 40\text{ns}$, $C_L = 15\text{pF}$		2	6	ns
Data Rate	FOD0710				12.5	Mb/s
	FOD0720, FOD0721				25	Mb/s
t_{PSK}	Propagation Delay Skew	$C_L = 15\text{pF}^{(3)}$			20	ns
t_R	Output Rise Time (10%–90%)			5		ns
t_F	Output Fall Time (90%–10%)			4.5		ns
$ CM_H $	Common Mode Transient Immunity at Output High	$V_I = V_{DD1}$, $V_O > 0.8 V_{DD2}$ $V_{CM} = 1000\text{V}^{(4)}$	20	40		kV/ μs
$ CM_L $	Common Mode Transient Immunity at Output Low	$V_I = 0\text{V}$, $V_O < 0.8$, $V_{CM} = 1000\text{V}^{(4)}$	20	40		kV/ μs

Notes:

- t_{PSK} is equal to the magnitude of the worst case difference in t_{PHL} and/or t_{PLH} that will be seen between units at any given temperature within the recommended operating conditions.
- Common mode transient immunity at output high is the maximum tolerable (positive) dV_{cm}/dt on the leading edge of the common mode impulse signal. V_{cm} , to assure that the output will remain high. Common mode transient immunity at output low is the maximum tolerable (negative dV_{cm}/dt on the trailing edge of the common pulse signal, V_{cm} , to assure that the output will remain low.

Typical Performance Curves

Figure 1. Typical Output Voltage vs. Input Voltage

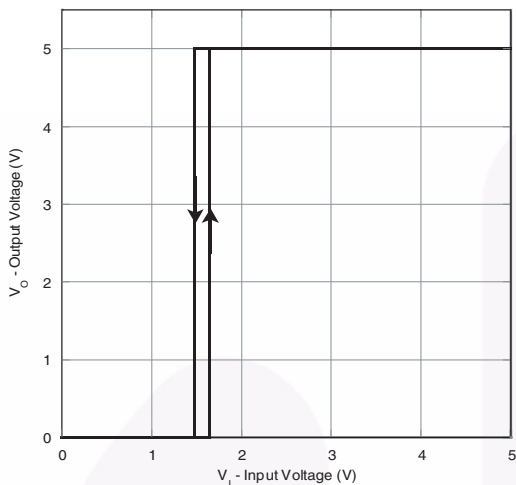

Figure 2. Typical Input Voltage Switching Threshold vs. Input Supply Voltage

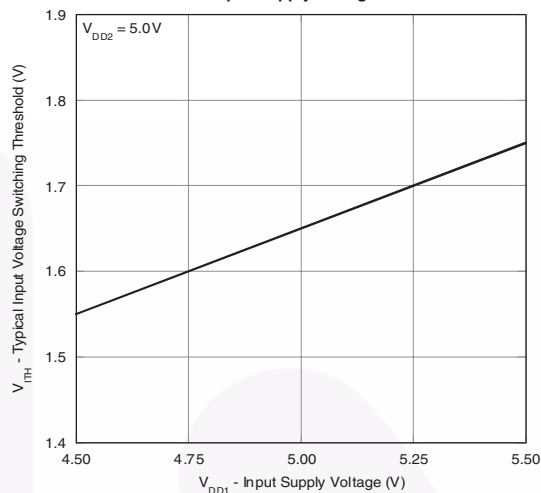

Figure 3. Typical Propagation Delay vs. Ambient Temperature (FOD0710)

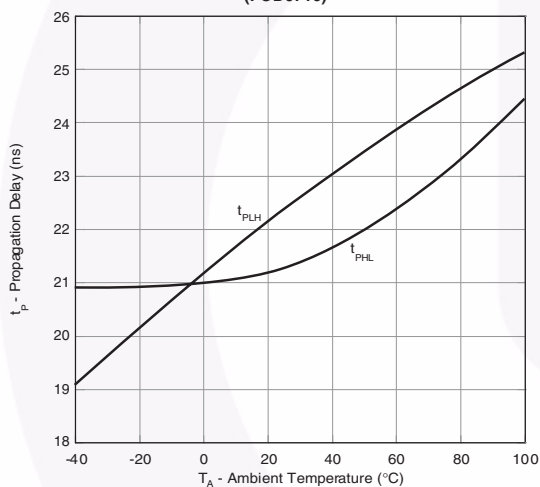

Figure 4. Typical Pulse Width Distortion vs. Ambient Temperature (FOD0710)

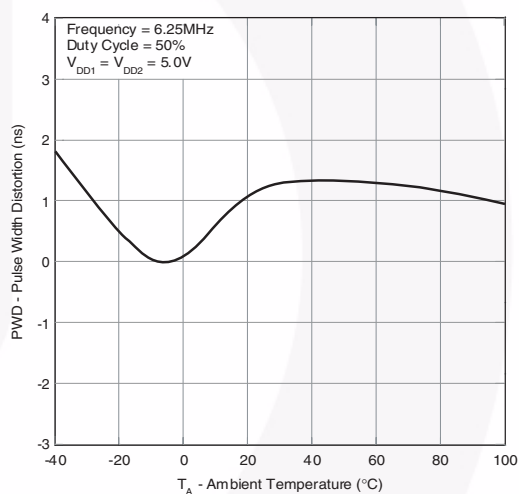

Figure 5. Typical Propagation Delay vs. Ambient Temperature (FOD0721/FOD0720)

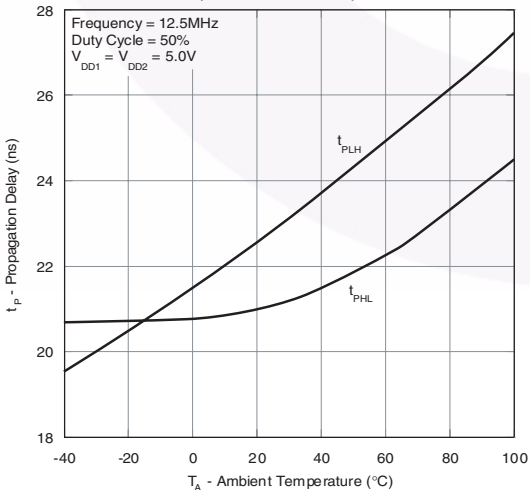
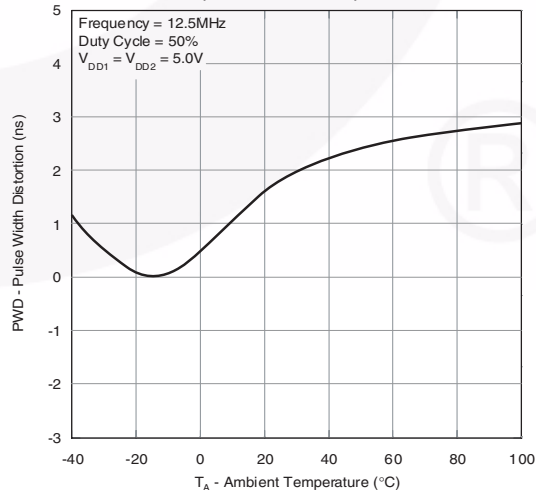

Figure 6. Typical Pulse Width Distortion vs. Ambient Temperature (FOD0721/FOD0720)



Typical Performance Curves (Continued)

Figure 7. Typical Rise and Fall Time vs. Ambient Temperature

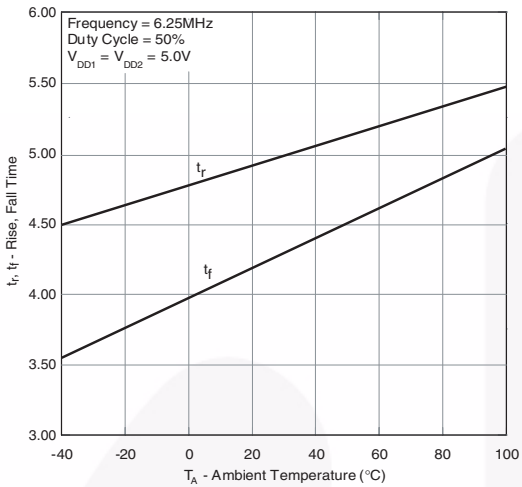

Figure 8. Typical Propagation Delay vs. Output Load Capacitance (FOD0710)

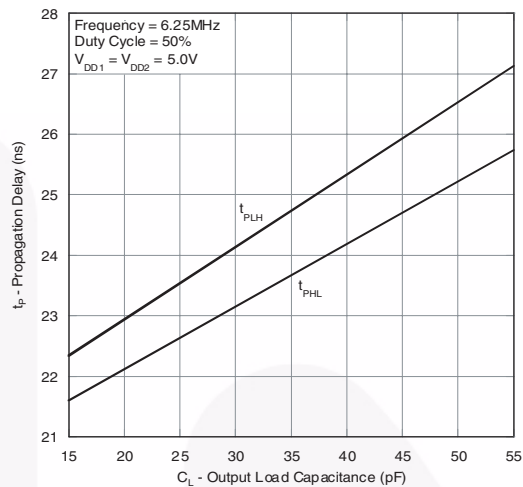

Figure 9. Typical Pulse Width Distortion vs. Output Load Capacitance (FOD0710)

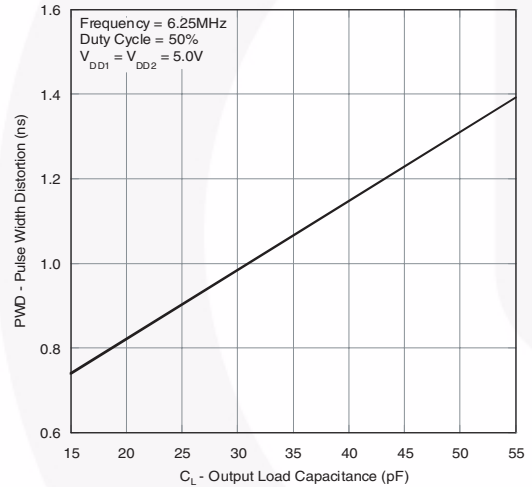

Figure 10. Typical Propagation Delay vs. Output Load Capacitance (FOD0721/FOD0720)

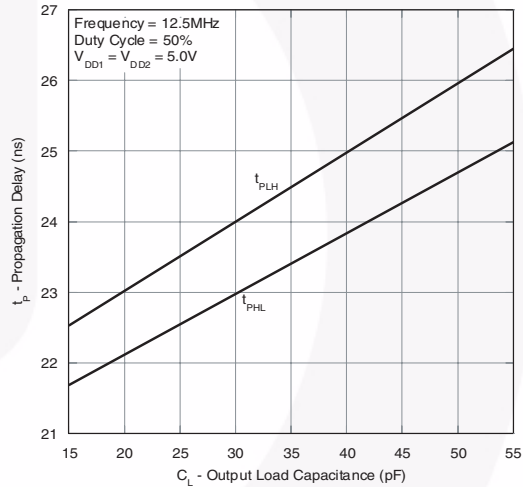

Figure 11. Typical Pulse Width Distortion vs. Output Load Capacitance (FOD0721/FOD0720)

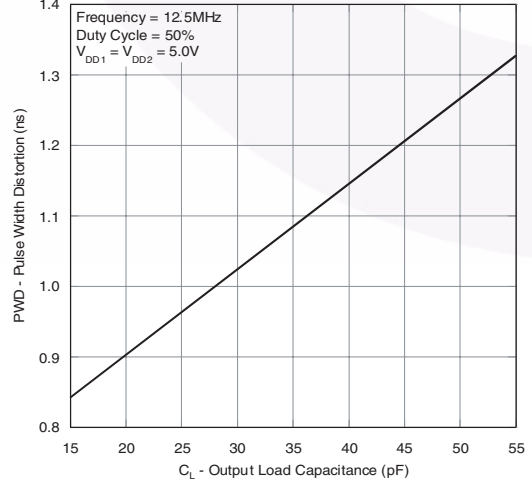
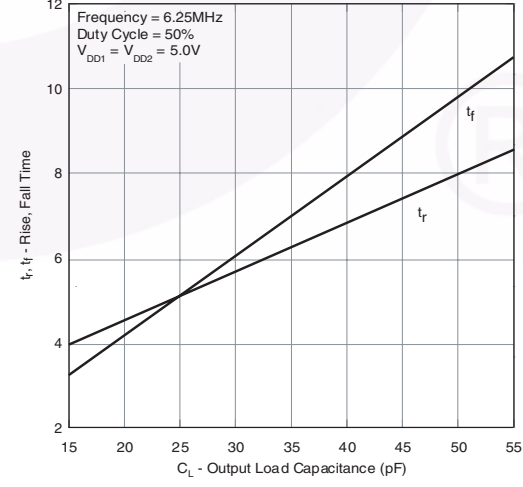

Figure 12. Typical Rise and Fall Time vs. Output Load Capacitance (FOD0710)



Typical Performance Curves (Continued)

Figure 13. Typical Rise and Fall Time vs. Output Load Capacitance (FOD0721/FOD0720)

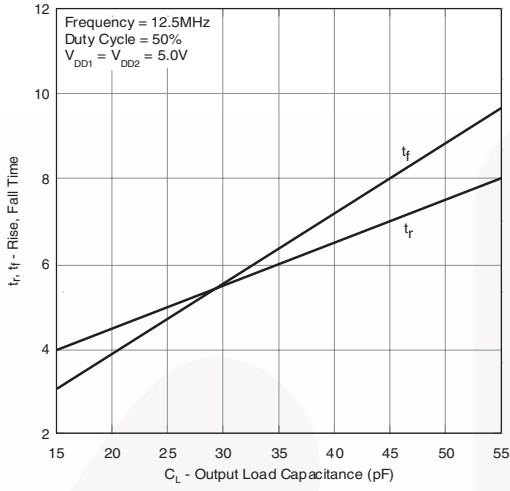

Figure 14. Typical Input Supply Current vs. Frequency

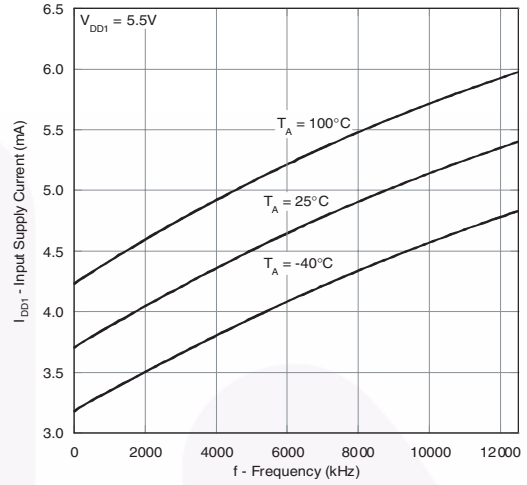
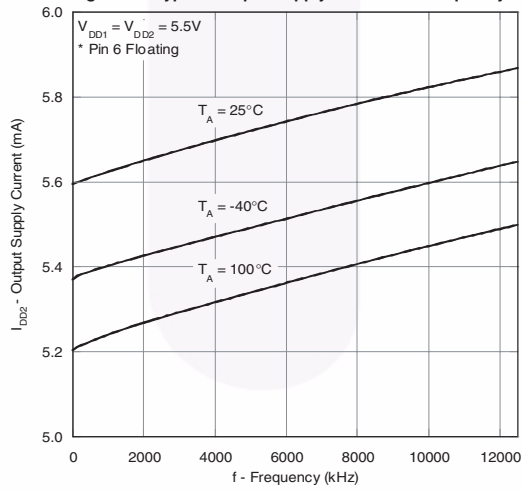



Figure 15. Typical Output Supply Current vs. Frequency



Ordering Information

Option	Order Entry Identifier	Description
No Suffix	FOD0721	Shipped in Tubes (50 units per tube)
R2	FOD0721R2	Tape and Reel (2500 units per reel)

 All packages are lead free per JEDEC: J-STD-020B standard.

Marking Information

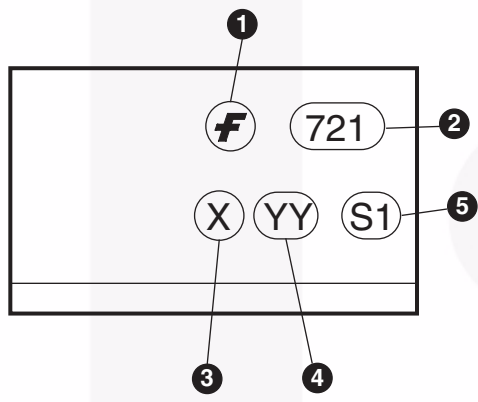

Definitions	
1	Fairchild logo
2	Device number
3	One digit year code, e.g., '8'
4	Two digit work week ranging from '01' to '53'
5	Assembly package code

Carrier Tape Specification

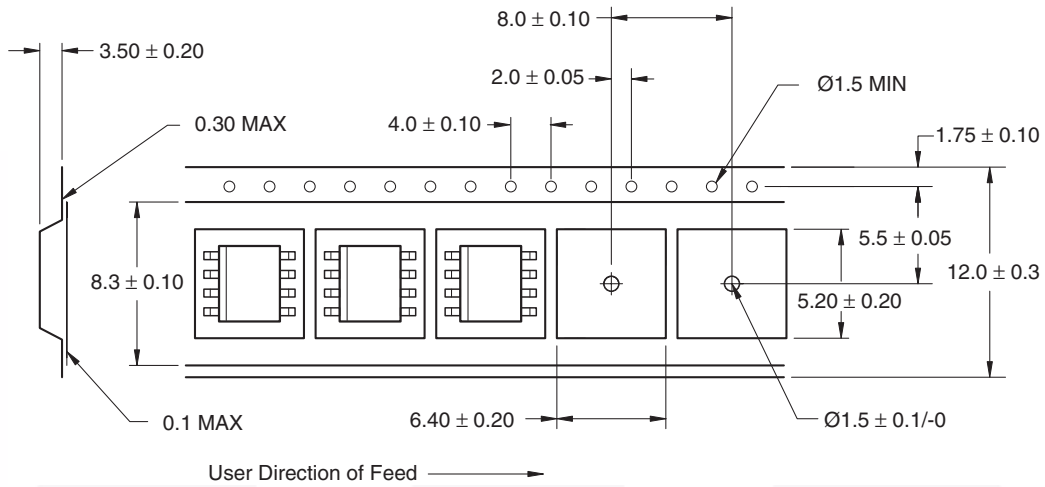

Note:
All dimensions are in millimeters.

Reflow Profile

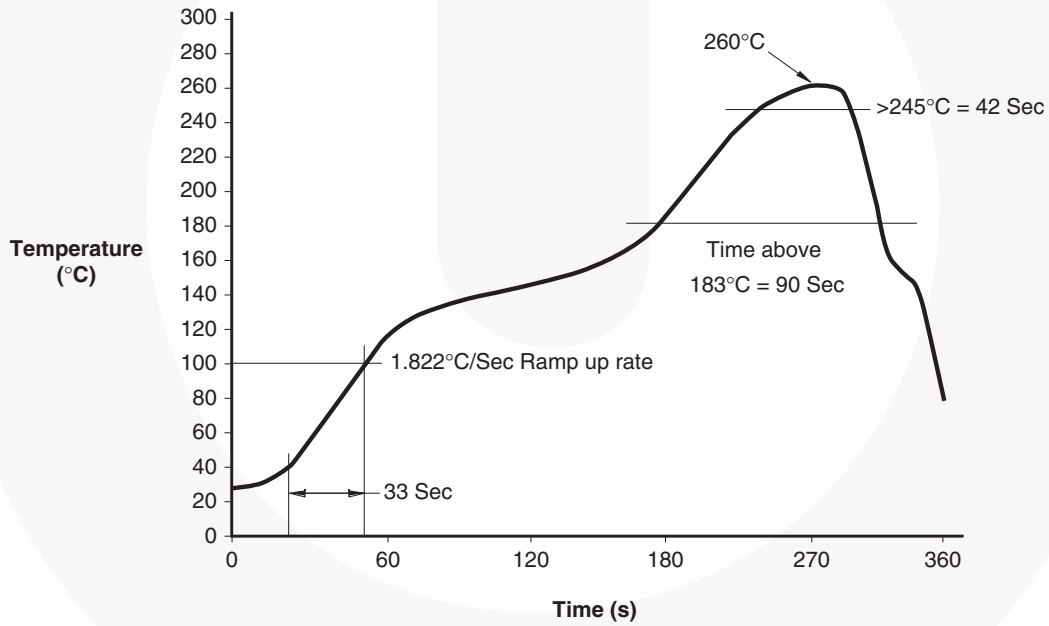

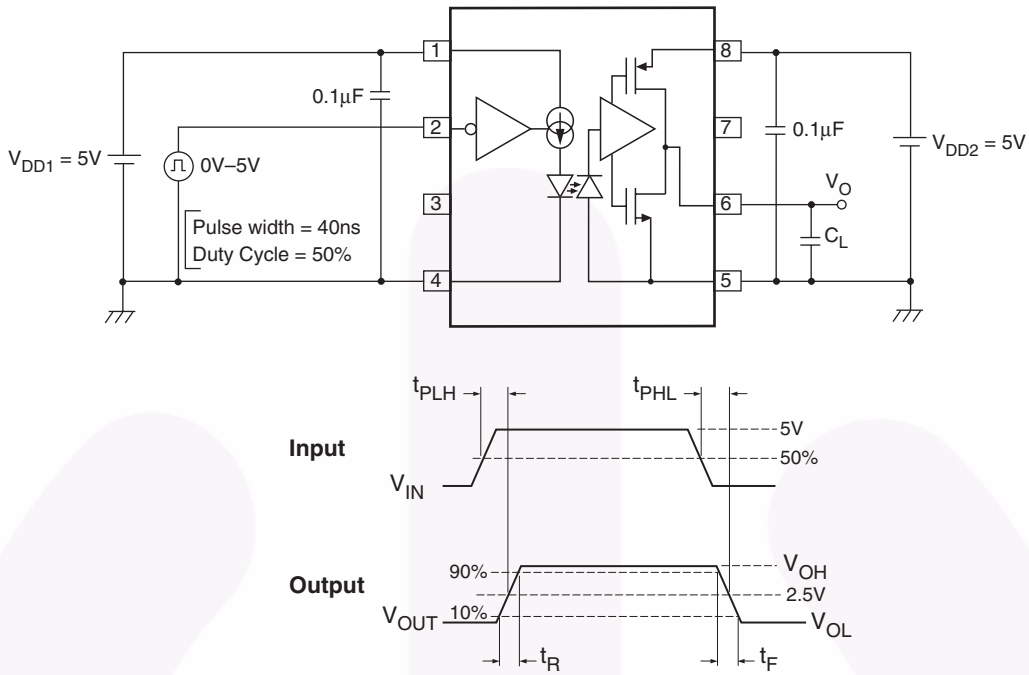

Figure 16. Test Circuit for Propagation Delay Time and Rise Time, Fall Time

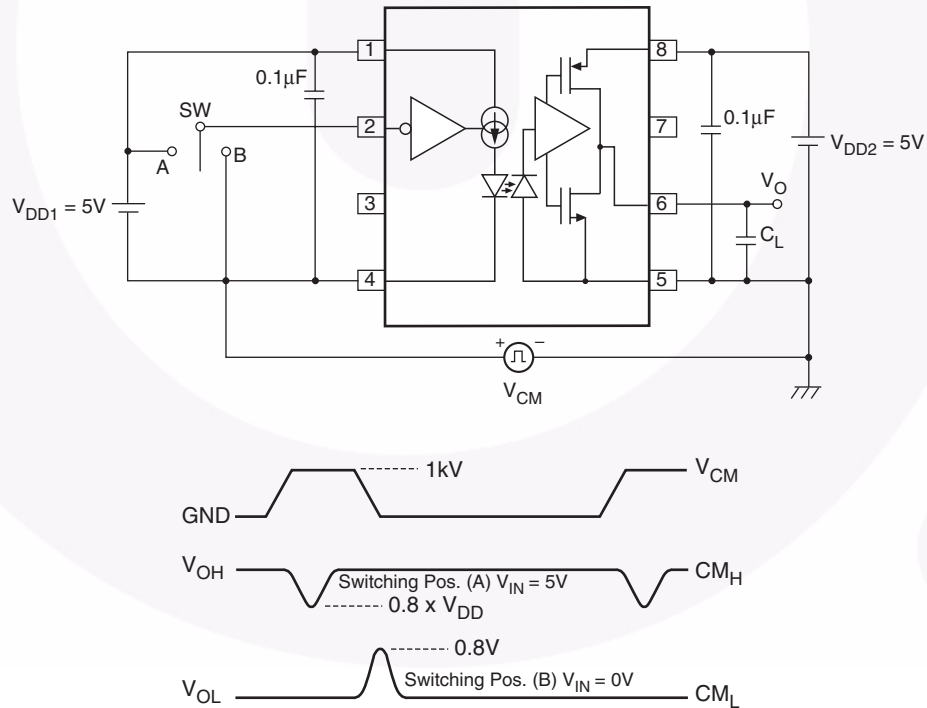

Figure 17. Test Circuit for Instantaneous Common Mode Rejection Voltage



NOTES:

- A) NO STANDARD APPLIES TO THIS PACKAGE
- B) ALL DIMENSIONS ARE IN MILLIMETERS.
- C) DIMENSIONS DO NOT INCLUDE MOLD FLASH OR BURRS.
- D) LANDPATTERN STANDARD: SOIC127P600X175-8M.
- E) DRAWING FILENAME: MKT-M08Erev5





TRADEMARKS

The following includes registered and unregistered trademarks and service marks, owned by Fairchild Semiconductor and/or its global subsidiaries, and is not intended to be an exhaustive list of all such trademarks.

- | | | | |
|--------------------------|--|---------------------------------------|------------------|
| AccuPower™ | F-PFS™ | OPTOPLANAR® | SYSTEM GENERAL® |
| AttitudeEngine™ | FRFET® | Power Supply WebDesigner™ | TinyBoost® |
| Awinda® | Global Power Resource SM | PowerTrench® | TinyBuck® |
| AX-CAP®* | GreenBridge™ | PowerXS™ | TinyCalc™ |
| BitSiC™ | Green FPS™ | Programmable Active Droop™ | TinyLogic® |
| Build it Now™ | Green FPS™ e-Series™ | QFET® | TINYOPTO™ |
| CorePLUS™ | Gmax™ | QS™ | TinyPower™ |
| CorePOWER™ | GTO™ | Quiet Series™ | TinyPWM™ |
| CROSSVOL™ | IntelliMAX™ | RapidConfigure™ | TinyWire™ |
| CTL™ | ISOPLANAR™ | Saving our world, 1mW/W/kW at a time™ | TranSiC™ |
| Current Transfer Logic™ | Making Small Speakers Sound Louder and Better™ | SignalWise™ | TriFault Detect™ |
| DEUXPEED® | MegaBuck™ | SmartMax™ | TRUECURRENT®* |
| Dual Cool™ | MICROCOUPLER™ | SMART START™ | μSerDes™ |
| EcoSPARK® | MicroFET™ | Solutions for Your Success™ | UHC® |
| EfficientMax™ | MicroPak™ | SPM® | Ultra FRFET™ |
| ESBC™ | MicroPak2™ | STEALTH™ | UniFET™ |
| F [®] | MillerDrive™ | SuperFET® | VCX™ |
| Fairchild® | MotionMax™ | SuperSOT™-3 | VisualMax™ |
| Fairchild Semiconductor® | MotionGrid® | SuperSOT™-6 | VoltagePlus™ |
| FACT Quiet Series™ | MTi® | SuperSOT™-8 | XST™ |
| FACT® | MTx® | SupreMOS® | Xsens™ |
| FastvCore™ | MVN® | SyncFET™ | 仙童® |
| FETBench™ | mWSaver® | Sync-Lock™ | |
| FPS™ | OptoHiT™ | | |
| | OPTOLOGIC® | | |

* Trademarks of System General Corporation, used under license by Fairchild Semiconductor.

DISCLAIMER

FAIRCHILD SEMICONDUCTOR RESERVES THE RIGHT TO MAKE CHANGES WITHOUT FURTHER NOTICE TO ANY PRODUCTS HEREIN TO IMPROVE RELIABILITY, FUNCTION, OR DESIGN. TO OBTAIN THE LATEST, MOST UP-TO-DATE DATASHEET AND PRODUCT INFORMATION, VISIT OUR WEBSITE AT [HTTP://WWW.FAIRCHILDSEMI.COM](http://www.fairchildsemi.com). FAIRCHILD DOES NOT ASSUME ANY LIABILITY ARISING OUT OF THE APPLICATION OR USE OF ANY PRODUCT OR CIRCUIT DESCRIBED HEREIN; NEITHER DOES IT CONVEY ANY LICENSE UNDER ITS PATENT RIGHTS, NOR THE RIGHTS OF OTHERS. THESE SPECIFICATIONS DO NOT EXPAND THE TERMS OF FAIRCHILD'S WORLDWIDE TERMS AND CONDITIONS, SPECIFICALLY THE WARRANTY THEREIN, WHICH COVERS THESE PRODUCTS.

AUTHORIZED USE

Unless otherwise specified in this data sheet, this product is a standard commercial product and is not intended for use in applications that require extraordinary levels of quality and reliability. This product may not be used in the following applications, unless specifically approved in writing by a Fairchild officer: (1) automotive or other transportation, (2) military/aerospace, (3) any safety critical application – including life critical medical equipment – where the failure of the Fairchild product reasonably would be expected to result in personal injury, death or property damage. Customer's use of this product is subject to agreement of this Authorized Use policy. In the event of an unauthorized use of Fairchild's product, Fairchild accepts no liability in the event of product failure. In other respects, this product shall be subject to Fairchild's Worldwide Terms and Conditions of Sale, unless a separate agreement has been signed by both Parties.

ANTI-COUNTERFEITING POLICY

Fairchild Semiconductor Corporation's Anti-Counterfeiting Policy. Fairchild's Anti-Counterfeiting Policy is also stated on our external website, www.fairchildsemi.com, under Terms of Use

Counterfeiting of semiconductor parts is a growing problem in the industry. All manufacturers of semiconductor products are experiencing counterfeiting of their parts. Customers who inadvertently purchase counterfeit parts experience many problems such as loss of brand reputation, substandard performance, failed applications, and increased cost of production and manufacturing delays. Fairchild is taking strong measures to protect ourselves and our customers from the proliferation of counterfeit parts. Fairchild strongly encourages customers to purchase Fairchild parts either directly from Fairchild or from Authorized Fairchild Distributors who are listed by country on our web page cited above. Products customers buy either from Fairchild directly or from Authorized Fairchild Distributors are genuine parts, have full traceability, meet Fairchild's quality standards for handling and storage and provide access to Fairchild's full range of up-to-date technical and product information. Fairchild and our Authorized Distributors will stand behind all warranties and will appropriately address any warranty issues that may arise. Fairchild will not provide any warranty coverage or other assistance for parts bought from Unauthorized Sources. Fairchild is committed to combat this global problem and encourage our customers to do their part in stopping this practice by buying direct or from authorized distributors.

PRODUCT STATUS DEFINITIONS

Definition of Terms

Datasheet Identification	Product Status	Definition
Advance Information	Formative / In Design	Datasheet contains the design specifications for product development. Specifications may change in any manner without notice.
Preliminary	First Production	Datasheet contains preliminary data; supplementary data will be published at a later date. Fairchild Semiconductor reserves the right to make changes at any time without notice to improve design.
No Identification Needed	Full Production	Datasheet contains final specifications. Fairchild Semiconductor reserves the right to make changes at any time without notice to improve the design.
Obsolete	Not In Production	Datasheet contains specifications on a product that is discontinued by Fairchild Semiconductor. The datasheet is for reference information only.

Rev. I77

Mouser Electronics

Authorized Distributor

Click to View Pricing, Inventory, Delivery & Lifecycle Information:

[Fairchild Semiconductor:](#)

[FOD0710R2](#) [FOD0710](#)