



Is Now Part of



**ON Semiconductor®**

To learn more about ON Semiconductor, please visit our website at  
[www.onsemi.com](http://www.onsemi.com)

ON Semiconductor and the ON Semiconductor logo are trademarks of Semiconductor Components Industries, LLC dba ON Semiconductor or its subsidiaries in the United States and/or other countries. ON Semiconductor owns the rights to a number of patents, trademarks, copyrights, trade secrets, and other intellectual property. A listing of ON Semiconductor's product/patent coverage may be accessed at [www.onsemi.com/site/pdf/Patent-Marking.pdf](http://www.onsemi.com/site/pdf/Patent-Marking.pdf). ON Semiconductor reserves the right to make changes without further notice to any products herein. ON Semiconductor makes no warranty, representation or guarantee regarding the suitability of its products for any particular purpose, nor does ON Semiconductor assume any liability arising out of the application or use of any product or circuit, and specifically disclaims any and all liability, including without limitation special, consequential or incidental damages. Buyer is responsible for its products and applications using ON Semiconductor products, including compliance with all laws, regulations and safety requirements or standards, regardless of any support or applications information provided by ON Semiconductor. "Typical" parameters which may be provided in ON Semiconductor data sheets and/or specifications can and do vary in different applications and actual performance may vary over time. All operating parameters, including "Typicals" must be validated for each customer application by customer's technical experts. ON Semiconductor does not convey any license under its patent rights nor the rights of others. ON Semiconductor products are not designed, intended, or authorized for use as a critical component in life support systems or any FDA Class 3 medical devices or medical devices with a same or similar classification in a foreign jurisdiction or any devices intended for implantation in the human body. Should Buyer purchase or use ON Semiconductor products for any such unintended or unauthorized application, Buyer shall indemnify and hold ON Semiconductor and its officers, employees, subsidiaries, affiliates, and distributors harmless against all claims, costs, damages, and expenses, and reasonable attorney fees arising out of, directly or indirectly, any claim of personal injury or death associated with such unintended or unauthorized use, even if such claim alleges that ON Semiconductor was negligent regarding the design or manufacture of the part. ON Semiconductor is an Equal Opportunity/Affirmative Action Employer. This literature is subject to all applicable copyright laws and is not for resale in any manner.



# FPF1504 / FPF1504L

## Advanced Load Management Switch

### Features

- 1.0 V to 3.6 V Input Voltage Operating Range
- Typical  $R_{DS(ON)}$ :
  - 15 m $\Omega$  at  $V_{IN}=3.3$  V
  - 20 m $\Omega$  at  $V_{IN}=1.8$  V
  - 40 m $\Omega$  at  $V_{IN}=1.0$  V
- Slew Rate Control
- Output Discharge Function
- Low <1  $\mu$ A Quiescent Current at  $V_{ON}=V_{IN}$
- ESD Protected: 4000 V HBM, 2000 V CDM
- GPIO/CMOS-Compatible Enable Circuitry
- Active HIGH and active LOW versions

### Applications

- Mobile Devices and Smart Phones
- Portable Media Devices
- Digital Cameras
- Advanced Notebook, UMPC, and MID
- Portable Medical Devices
- GPS and Navigation Equipment

### Description

The FPF1504/FPF1504L are low- $R_{DS}$  P-channel MOSFET load switches of the IntelliMAX™ family. Integrated slew-rate control prevents excessive inrush current from the supply rails with capacitive loads common in power applications. In addition, the FPF1504/FPF1504L feature output discharge capability.

The input voltage range operates from 1.0 V to 3.6 V to fulfill today's mobile device supply requirements. Switch control is by a logic input (ON pin) capable of interfacing directly with low-voltage CMOS control signals and GPIOs in embedded processors.

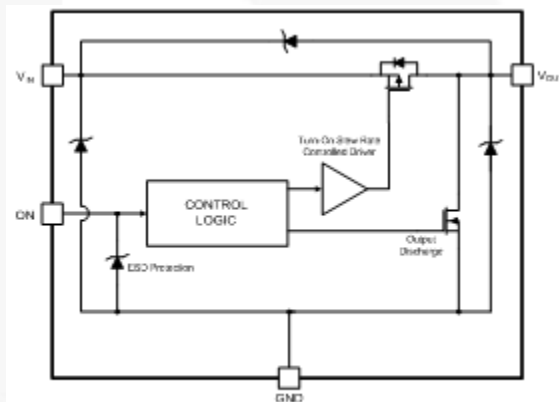

Figure 1. Block Diagram

### Ordering Information

Part Number	Top Mark	Switch (Typical) At 1.8 V <sub>IN</sub>	Input Buffer	Output Discharge	ON Pin Activity	Package
FPF1504UCX	G4	20 m $\Omega$	CMOS	YES	Active HIGH	4-Ball, WLCSP, 0.5 mm Pitch
FPF1504BUCX	G4	20 m $\Omega$	CMOS	YES	Active HIGH	4-Ball, WLCSP with Backside Laminate, 0.5 mm Pitch
FPF1504LUCX	GZ	20 m $\Omega$	CMOS	YES	Active LOW	4-Ball, WLCSP, 0.5 mm Pitch
FPF1504LBUCX	GZ	20 m $\Omega$	CMOS	YES	Active LOW	4-Ball, WLCSP with Backside Laminate, 0.5 mm Pitch

### Application Diagram

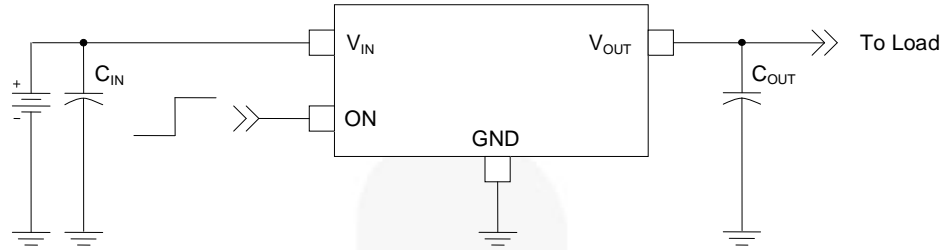

Figure 2. Typical Application

**Notes:**

1.  $C_{IN}=1\ \mu\text{F}$ , X5R, 0603, for example Murata GRM185R60J105KE26.
2.  $C_{OUT}=1\ \mu\text{F}$ , X5R, 0805, for example Murata GRM216R61A105KA01.

### Pin Configurations

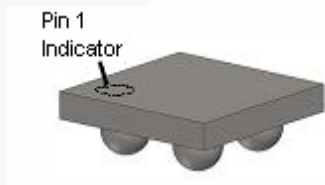

Figure 3. 1 x 1 mm WLCSP Bumps Facing Down

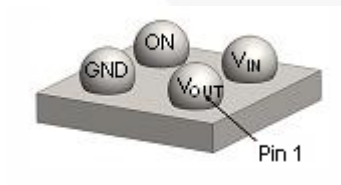

Figure 4. 1 x 1 mm WLCSP Bumps Facing Up

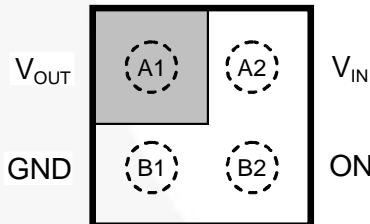

Figure 5. Pin Assignments (Top View)

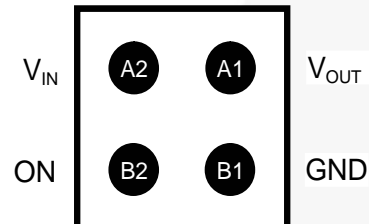

Figure 6. Pin Assignments (Bottom View)

### Pin Definitions

Pin #	Name	Description
A1	$V_{OUT}$	Switch Output
A2	$V_{IN}$	Supply Input; Input to the Power Switch
B1	GND	Ground
B2	ON	ON/OFF Control

## Absolute Maximum Ratings

Stresses exceeding the absolute maximum ratings may damage the device. The device may not function or be operable above the recommended operating conditions and stressing the parts to these levels is not recommended. In addition, extended exposure to stresses above the recommended operating conditions may affect device reliability. The absolute maximum ratings are stress ratings only.

Symbol	Parameter	Min.	Max.	Unit
$V_{IN}$	$V_{IN}$ , $V_{OUT}$ , $V_{ON}$ to GND	-0.3	4.0	V
$I_{SW}$	Maximum Continuous Switch Current		1.5	A
$P_D$	Power Dissipation at $T_A=25^\circ\text{C}$		1.0	W
$T_{STG}$	Storage Junction Temperature	-65	+150	$^\circ\text{C}$
$T_A$	Operating Temperature Range	-40	+85	$^\circ\text{C}$
$\Theta_{JA}$	Thermal Resistance, Junction-to-Ambient	1S2P with 1 Thermal Via	95	$^\circ\text{C}/\text{W}$
		1S2P without Thermal Via	187	
ESD	Electrostatic Discharge Capability	Human Body Model, JESD22-A114	4	kV
		Charged Device Model, JESD22-C101	2	

## Recommended Operating Conditions

The Recommended Operating Conditions table defines the conditions for actual device operation. Recommended operating conditions are specified to ensure optimal performance to the datasheet specifications. Fairchild does not recommend exceeding them or designing to Absolute Maximum Ratings.

Symbol	Parameter	Min.	Max.	Unit
$V_{IN}$	Supply Voltage	1.0	3.6	V
$T_A$	Ambient Operating Temperature	-40	+85	$^\circ\text{C}$

## Electrical Characteristics

Unless otherwise noted,  $V_{IN}=1.0$  to  $3.6$  V,  $T_A=-40$  to  $+85^\circ\text{C}$ ; typical values are at  $V_{IN}=3.3$  V and  $T_A=25^\circ\text{C}$ .

Symbol	Parameter		Conditions	Min.	Typ.	Max.	Units	
<b>Basic Operation</b>								
$V_{IN}$	Supply Voltage			1.0		3.6	V	
$I_{Q(OFF)}$	Off Supply Current	FPF1504	$V_{ON}=\text{GND}, V_{OUT}=\text{Open}$		0.25		$\mu\text{A}$	
		FPF1504L	$V_{ON}=V_{IN}, V_{OUT}=\text{Open}$		0.3			
$I_{SD(OFF)}$	Off Switch Current	FPF1504	$V_{ON}=\text{GND}, V_{OUT}=\text{GND}$		0.25			
		FPF1504L	$V_{ON}=V_{IN}, V_{OUT}=\text{GND}$		0.3			
$I_Q$	Quiescent Current	FPF1504	$I_{OUT}=0$ mA, $V_{IN}=3.6$ V, $V_{ON}=V_{IN}$		0.08			
			$I_{OUT}=0$ mA, $V_{ON}=V_{IH(MIN)}$		0.75			
		FPF1504L	$I_{OUT}=0$ mA, $V_{IN}=3.6$ V, $V_{ON}=\text{GND}$		0.08			
			$I_{OUT}=0$ mA, $V_{ON}=V_{IL(MAX)}$		0.95			
$R_{ON}$	On Resistance	$V_{IN}=3.3$ V, $I_{OUT}=200$ mA, $T_A=25^\circ\text{C}$			15	30	$\text{m}\Omega$	
		$V_{IN}=1.8$ V, $I_{OUT}=200$ mA, $T_A=25^\circ\text{C}$			20	40		
		$V_{IN}=1.5$ V, $I_{OUT}=200$ mA, $T_A=25^\circ\text{C}$			30			
		$V_{IN}=1.0$ V, $I_{OUT}=200$ mA, $T_A=25^\circ\text{C}$			40	80		
		$V_{IN}=1.8$ V, $I_{OUT}=200$ mA, $T_A=85^\circ\text{C}^{(3)}$			35	50		
$R_{PD}$	Output Discharge Pull-Down Resistance		$V_{ON}=0$ V or $V_{IN}, I_{OUT}=-20$ mA		65	95	$\Omega$	
$V_{IH}$	On Input Logic High Voltage	FPF1504		0.8			V	
$V_{IL}$	On Input Logic Low Voltage	FPF1504				0.3		
$I_{ON}$	On Input Leakage		$V_{ON}=V_{IN}$ or GND			1	$\mu\text{A}$	
<b>Dynamic Characteristics</b>								
$t_{DON}$	Turn-On Delay <sup>(4)</sup>	FPF1504	$R_L=10$ $\Omega$ , $C_L=0.1$ $\mu\text{F}$ , $V_{IN}=3.3$ V, $T_A=25^\circ\text{C}$		80		$\mu\text{s}$	
$t_R$	$V_{OUT}$ Rise Time <sup>(4)</sup>	FPF1504				130		
$t_{ON}$	Turn-On Time <sup>(4)</sup>	FPF1504				210		
$t_{DON}$	Turn-On Delay <sup>(4)</sup>	FPF1504	$R_L=500$ $\Omega$ , $C_L=0.1$ $\mu\text{F}$ , $V_{IN}=3.3$ V, $T_A=25^\circ\text{C}$		70	100	$\mu\text{s}$	
		FPF1504L				95		
$t_R$	$V_{OUT}$ Rise Time <sup>(4)</sup>	FPF1504				110		150
		FPF1504L				115		
$t_{ON}$	Turn-On Time <sup>(4)</sup>	FPF1504				180		250
		FPF1504L				210		

Continued on the following page...

## Electrical Characteristics (Continued)

Unless otherwise noted,  $V_{IN}=1.0$  to  $3.6$  V,  $T_A=-40$  to  $+85^\circ\text{C}$ ; typical values are at  $V_{IN}=3.3$  V and  $T_A=25^\circ\text{C}$ .

Symbol	Parameter	Conditions	Min.	Typ.	Max.	Units
<b>Dynamic Characteristics (Continued)</b>						
$t_{DOFF}$	Turn-Off Delay <sup>(4)</sup>	FPF1504		25	30	$\mu\text{s}$
$t_F$	$V_{OUT}$ Fall Time <sup>(4)</sup>	FPF1504	$R_L=10\ \Omega$ , $C_L=0.1\ \mu\text{F}$ , $V_{IN}=3.3\ \text{V}$ , $T_A=25^\circ\text{C}$	2		
$t_{OFF}$	Turn-Off Time <sup>(4)</sup>	FPF1504		27		
$t_{DOFF}$	Turn-Off Delay <sup>(4)</sup>	FPF1504 FPF1504L			25 2	
$t_F$	$V_{OUT}$ Fall Time <sup>(4)</sup>	FPF1504 FPF1504L	$R_L=500\ \Omega$ , $C_L=0.1\ \mu\text{F}$ , $V_{IN}=3.3\ \text{V}$ , $T_A=25^\circ\text{C}$	12 14		
$t_{OFF}$	Turn-Off Time <sup>(4)</sup>	FPF1504 FPF1504L		37 16		

**Notes:**

3. This parameter is guaranteed by design and characterization; not production tested.
4.  $t_{DON}/t_{DOFF}/t_R/t_F$  are defined in Figure 7.
5. Output discharge path is enabled during off.

### Timing Diagram – FPF1504

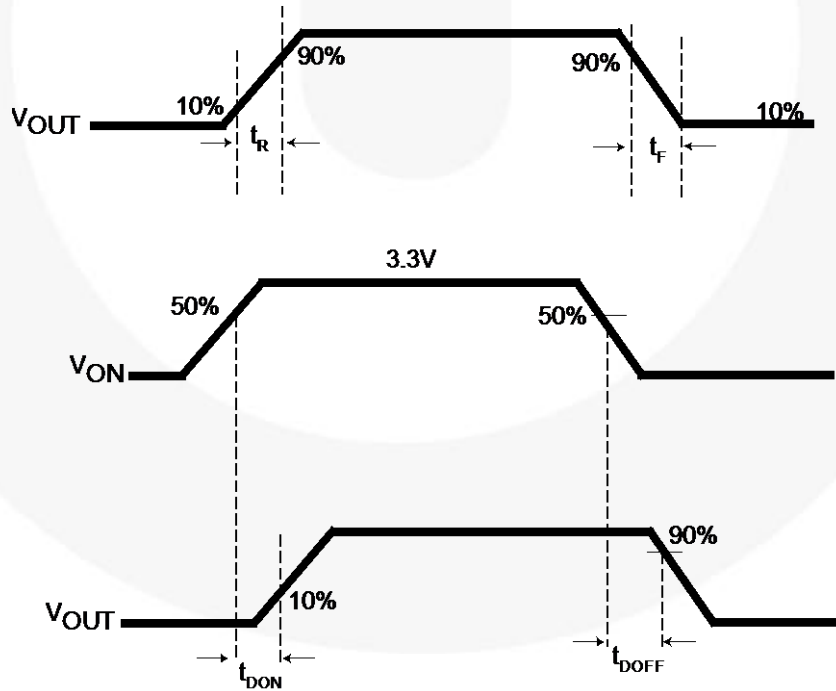

**Notes:**

6.  $t_{ON}=t_R + t_{DON}$ .
7.  $t_{OFF}=t_F + t_{DOFF}$ .

Figure 7. Timing Diagram for FPF1504

## Typical Performance Characteristics for FPF1504

Applicable to active high version only.

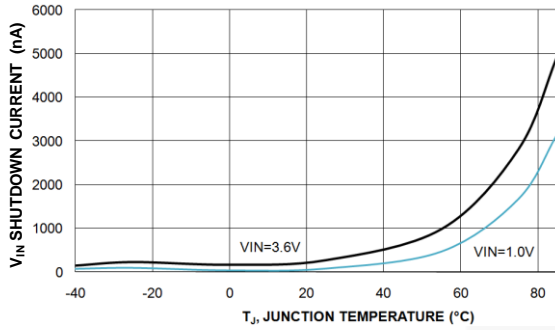

**Figure 8. Shutdown Current vs. Temperature**

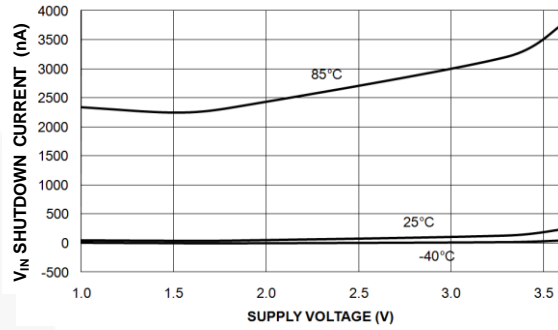

**Figure 9. Shutdown Current vs. Supply Voltage**

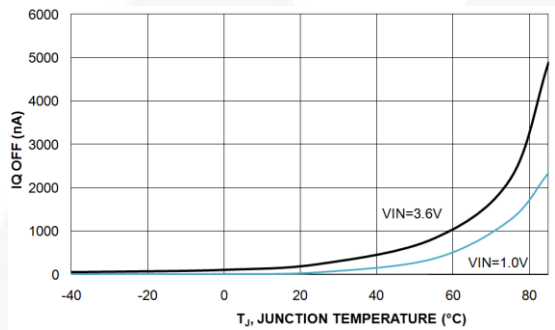

**Figure 10. Off Supply Current vs. Temperature**

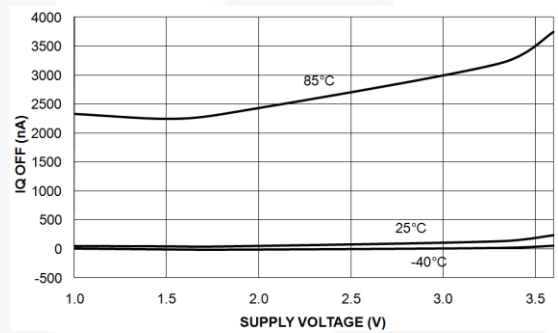

**Figure 11. Off Supply Current vs. Supply Voltage**

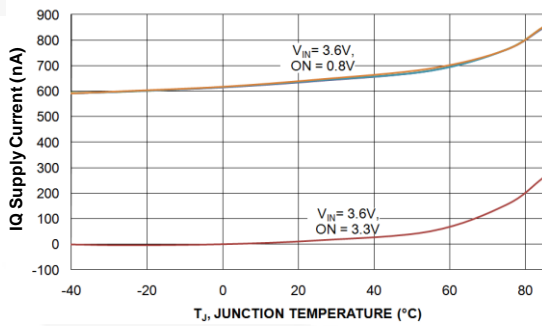

**Figure 12. Quiescent Current vs. Temperature**

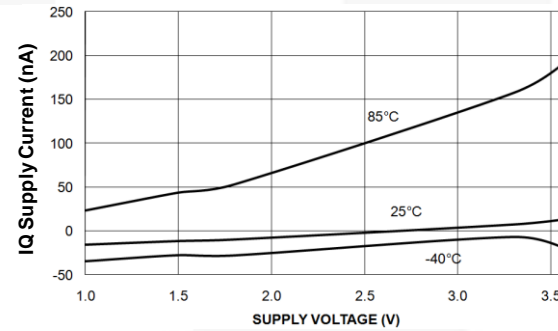

**Figure 13. Quiescent Current vs. Supply Voltage (V<sub>ON</sub>=V<sub>IN</sub>)**

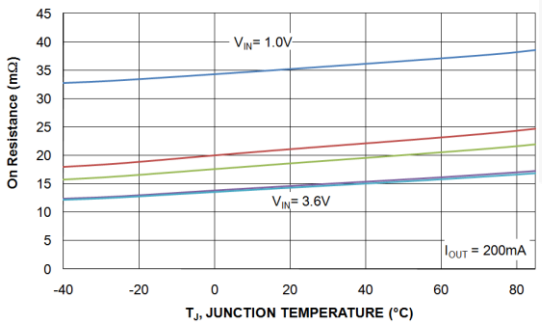

**Figure 14. R<sub>ON</sub> vs. Temperature**

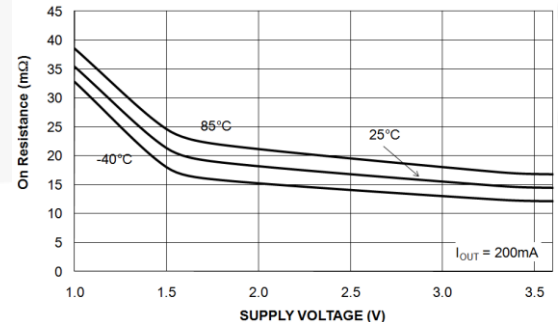

**Figure 15. R<sub>ON</sub> vs. Supply Voltage**

## Typical Performance Characteristics for FPF1504

Applicable to active high version only.

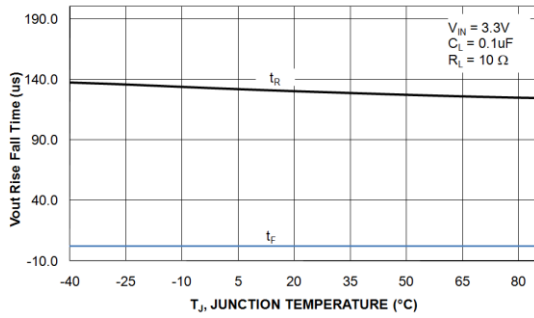

**Figure 16.  $V_{OUT}$  Rise/Fall Times vs. Temperature ( $R_L=10\ \Omega$ )**

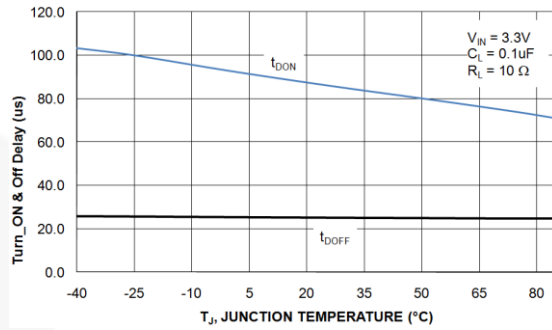

**Figure 17.  $V_{OUT}$  Turn-On/Turn-Off Delays vs. Temperature ( $R_L=10\ \Omega$ )**

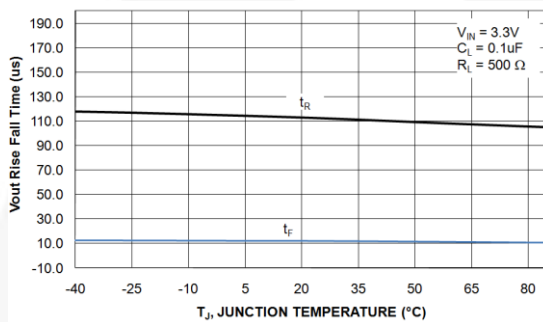

**Figure 18.  $V_{OUT}$  Rise/Fall Time vs. Temperature ( $R_L=500\ \Omega$ )**

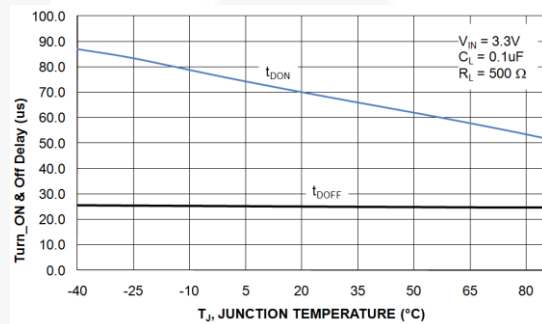

**Figure 19.  $V_{OUT}$  Turn-On/Turn-Off Delays vs. Temperature ( $R_L=500\ \Omega$ )**

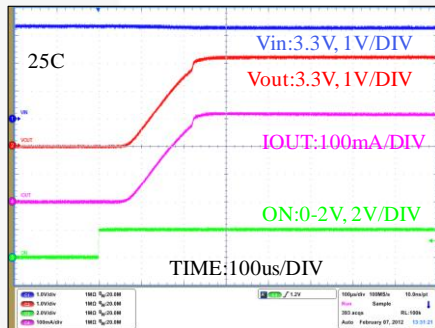

**Figure 20. Turn-On Response ( $V_{IN}=3.3\ \text{V}$ ,  $C_{OUT}=0.1\ \mu\text{F}$ ,  $R_L=10\ \Omega$ )**

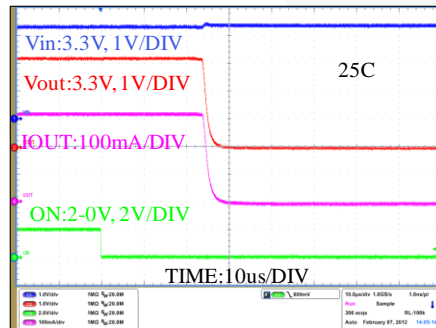

**Figure 21. Turn-Off Response ( $V_{IN}=3.3\ \text{V}$ ,  $C_{OUT}=0.1\ \mu\text{F}$ ,  $R_L=10\ \Omega$ )**

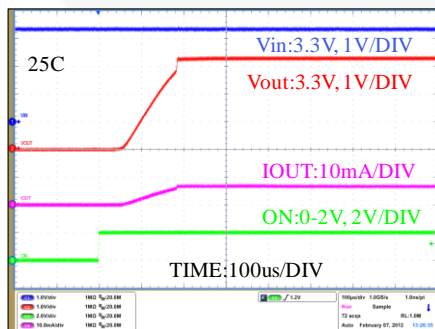

**Figure 22. Turn-On Response ( $V_{IN}=3.3\ \text{V}$ ,  $C_{OUT}=0.1\ \mu\text{F}$ ,  $R_L=500\ \Omega$ )**

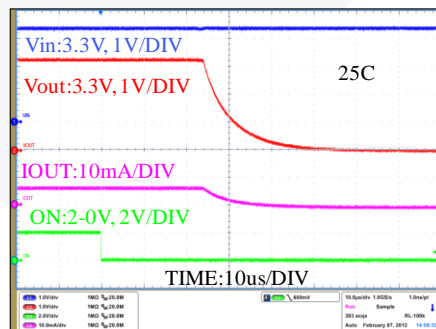

**Figure 23. Turn-Off Response ( $V_{IN}=3.3\ \text{V}$ ,  $C_{OUT}=0.1\ \mu\text{F}$ ,  $R_L=500\ \Omega$ )**



## Application Information

### Input Capacitor

IntelliMAX™ switches don't require an input capacitor. To reduce device inrush current, a 0.1 μF ceramic capacitor, C<sub>IN</sub>, is recommended close to the VIN pin. A higher value of C<sub>IN</sub> can be used to further reduce the voltage drop experienced as the switch is turned on into a large capacitive load.

### Output Capacitor

IntelliMAX™ switches work without an output capacitor. If the applications parasitic board inductance forces V<sub>OUT</sub> below GND when switching off, a 0.1 μF capacitor, C<sub>OUT</sub>, should be placed between V<sub>OUT</sub> and GND.

### Fall Time

Device output fall time can be calculated based on RC constant of external components as follows:

$$t_F = R_L \times C_L \times 2.2 \quad (1)$$

where t<sub>F</sub> is 90% to 10% fall time, R<sub>L</sub> is output load, load and C<sub>L</sub> is output capacitor.

The same equation works for a device with a pull-down output resistor, then R<sub>L</sub> is replaced by a parallel connected pull-down and external output resistor combination, as follows:

$$t_F = \frac{R_L \times R_{PD}}{R_L + R_{PD}} \times C_L \times 2.2 \quad (2)$$

where t<sub>F</sub> is 90% to 10% fall time, R<sub>L</sub> is output load, R<sub>PD</sub> is output pull-down resistor (65 Ω typical), and C<sub>L</sub> is the output capacitor.

## Recommended Land Pattern and Layout

For best thermal performance and minimal inductance and parasitic effects, it is recommended to keep input and output traces short and the capacitors as close to

the device as possible. Below is a recommended layout for this device to achieve optimum performance.

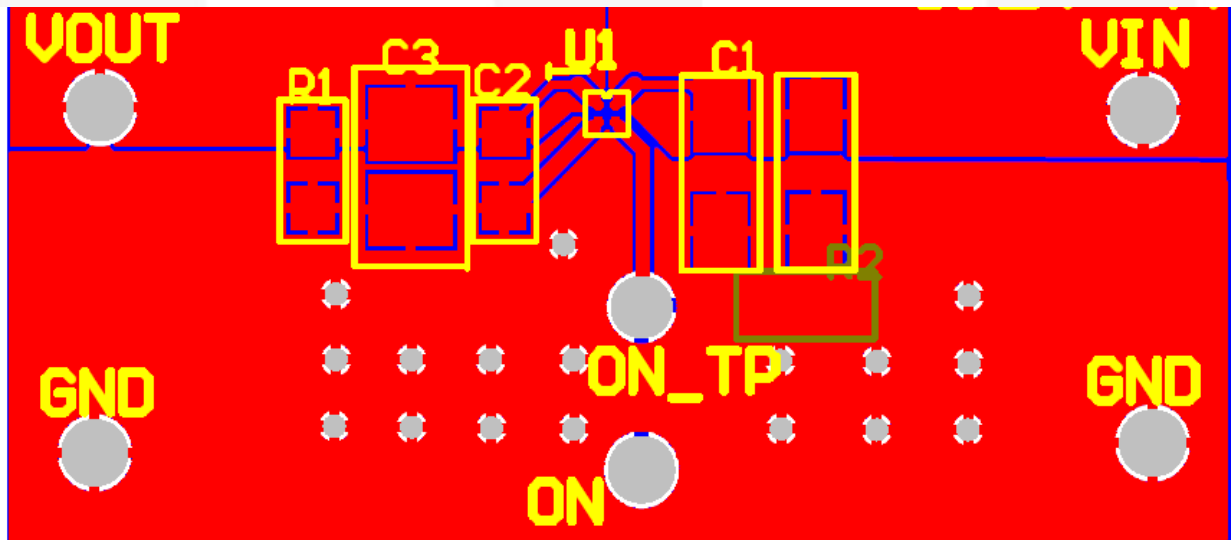

Figure 24. Recommended Land Pattern and Layout

The following information applies to the WLCSP package dimensions on the next page:

**Product-Specific Dimensions**

Product	D	E	X	Y
FPF1504UCX	960 $\mu\text{m}$ $\pm$ 30 $\mu\text{m}$	960 $\mu\text{m}$ $\pm$ 30 $\mu\text{m}$	0.230 mm	0.230 mm
FPF1504BUCX				
FPF1504LUCX				
FPF1504LBUCX				



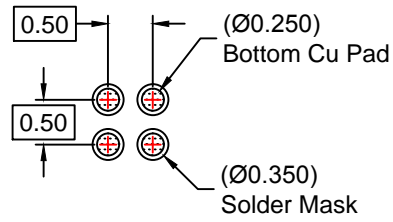
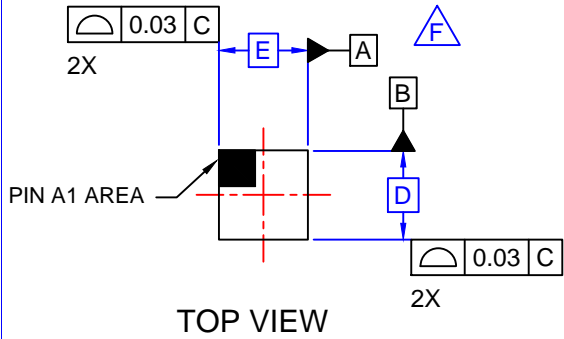

RECOMMENDED LAND PATTERN  
(NSMD PAD TYPE)

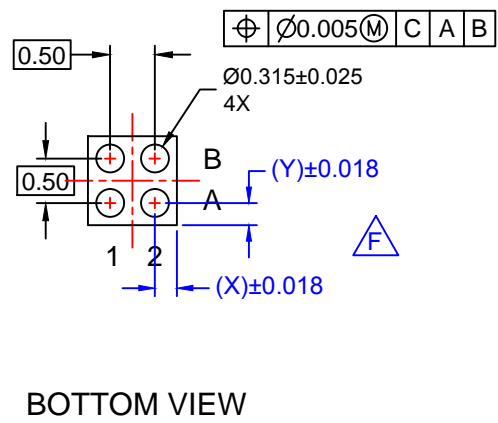
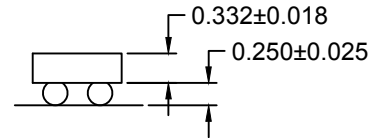
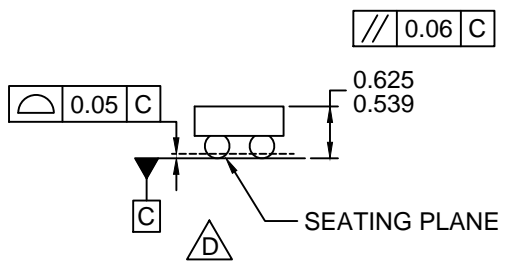

NOTES:

- A. NO JEDEC REGISTRATION APPLIES.
- B. DIMENSIONS ARE IN MILLIMETERS.
- C. DIMENSIONS AND TOLERANCES PER ASME Y14.5M, 2009.
- D. DATUM C IS DEFINED BY THE SPHERICAL CROWNS OF THE BALLS.
- E. PACKAGE NOMINAL HEIGHT IS 582 MICRONS ±43 MICRONS (539-625 MICRONS).
- F. FOR DIMENSIONS D, E, X, AND Y SEE PRODUCT DATASHEET.
- G. DRAWING FILENAME: MKT-UC004ABrev3.





**TRADEMARKS**

The following includes registered and unregistered trademarks and service marks, owned by Fairchild Semiconductor and/or its global subsidiaries, and is not intended to be an exhaustive list of all such trademarks.

- AccuPower™
- AttitudeEngine™
- Awinda®
- AX-CAP®\*
- BitSiC™
- Build it Now™
- CorePLUS™
- CorePOWER™
- CROSSVOL™
- CTL™
- Current Transfer Logic™
- DEUXPEED®
- Dual Cool™
- EcoSPARK®
- EfficientMax™
- ESBC™
- F**™
- Fairchild®
- Fairchild Semiconductor®
- FACT Quiet Series™
- FACT®
- FastvCore™
- FETBench™
- FPS™
- F-PFS™
- FRFET®
- Global Power Resource<sup>SM</sup>
- GreenBridge™
- Green FPS™
- Green FPS™ e-Series™
- Gmax™
- GTO™
- IntelliMAX™
- ISOPLANAR™
- Making Small Speakers Sound Louder and Better™
- MegaBuck™
- MICROCOUPLER™
- MicroFET™
- MicroPak™
- MicroPak2™
- MillerDrive™
- MotionMax™
- MotionGrid®
- MTi®
- MTx®
- MVN®
- mWSaver®
- OptoHiT™
- OPTOLOGIC®
- OPTOPLANAR®
- ®
- Power Supply WebDesigner™
- PowerTrench®
- PowerXS™
- Programmable Active Droop™
- QFET®
- QS™
- Quiet Series™
- RapidConfigure™
- ™
- Saving our world, 1mW/W/kW at a time™
- SignalWise™
- SmartMax™
- SMART START™
- Solutions for Your Success™
- SPM®
- STEALTH™
- SuperFET®
- SuperSOT™-3
- SuperSOT™-6
- SuperSOT™-8
- SupreMOS®
- SyncFET™
- Sync-Lock™
- ®
- TinyBoost®
- TinyBuck®
- TinyCalc™
- TinyLogic®
- TINYOPTO™
- TinyPower™
- TinyPWM™
- TinyWire™
- TranSiC™
- TriFault Detect™
- TRUECURRENT®\*
- μSerDes™
- ™
- UHC®
- Ultra FRFET™
- UniFET™
- VcX™
- VisualMax™
- VoltagePlus™
- XS™
- Xsens™
- 仙童®

\* Trademarks of System General Corporation, used under license by Fairchild Semiconductor.

**DISCLAIMER**

FAIRCHILD SEMICONDUCTOR RESERVES THE RIGHT TO MAKE CHANGES WITHOUT FURTHER NOTICE TO ANY PRODUCTS HEREIN TO IMPROVE RELIABILITY, FUNCTION, OR DESIGN. TO OBTAIN THE LATEST, MOST UP-TO-DATE DATASHEET AND PRODUCT INFORMATION, VISIT OUR WEBSITE AT [HTTP://WWW.FAIRCHILDSEMI.COM](http://www.fairchildsemi.com). FAIRCHILD DOES NOT ASSUME ANY LIABILITY ARISING OUT OF THE APPLICATION OR USE OF ANY PRODUCT OR CIRCUIT DESCRIBED HEREIN; NEITHER DOES IT CONVEY ANY LICENSE UNDER ITS PATENT RIGHTS, NOR THE RIGHTS OF OTHERS. THESE SPECIFICATIONS DO NOT EXPAND THE TERMS OF FAIRCHILD'S WORLDWIDE TERMS AND CONDITIONS, SPECIFICALLY THE WARRANTY THEREIN, WHICH COVERS THESE PRODUCTS.

**AUTHORIZED USE**

Unless otherwise specified in this data sheet, this product is a standard commercial product and is not intended for use in applications that require extraordinary levels of quality and reliability. This product may not be used in the following applications, unless specifically approved in writing by a Fairchild officer: (1) automotive or other transportation, (2) military/aerospace, (3) any safety critical application – including life critical medical equipment – where the failure of the Fairchild product reasonably would be expected to result in personal injury, death or property damage. Customer's use of this product is subject to agreement of this Authorized Use policy. In the event of an unauthorized use of Fairchild's product, Fairchild accepts no liability in the event of product failure. In other respects, this product shall be subject to Fairchild's Worldwide Terms and Conditions of Sale, unless a separate agreement has been signed by both Parties.

**ANTI-COUNTERFEITING POLICY**

Fairchild Semiconductor Corporation's Anti-Counterfeiting Policy. Fairchild's Anti-Counterfeiting Policy is also stated on our external website, [www.fairchildsemi.com](http://www.fairchildsemi.com), under Terms of Use

Counterfeiting of semiconductor parts is a growing problem in the industry. All manufacturers of semiconductor products are experiencing counterfeiting of their parts. Customers who inadvertently purchase counterfeit parts experience many problems such as loss of brand reputation, substandard performance, failed applications, and increased cost of production and manufacturing delays. Fairchild is taking strong measures to protect ourselves and our customers from the proliferation of counterfeit parts. Fairchild strongly encourages customers to purchase Fairchild parts either directly from Fairchild or from Authorized Fairchild Distributors who are listed by country on our web page cited above. Products customers buy either from Fairchild directly or from Authorized Fairchild Distributors are genuine parts, have full traceability, meet Fairchild's quality standards for handling and storage and provide access to Fairchild's full range of up-to-date technical and product information. Fairchild and our Authorized Distributors will stand behind all warranties and will appropriately address any warranty issues that may arise. Fairchild will not provide any warranty coverage or other assistance for parts bought from Unauthorized Sources. Fairchild is committed to combat this global problem and encourage our customers to do their part in stopping this practice by buying direct or from authorized distributors.

**PRODUCT STATUS DEFINITIONS**

**Definition of Terms**

Datasheet Identification	Product Status	Definition
Advance Information	Formative / In Design	Datasheet contains the design specifications for product development. Specifications may change in any manner without notice.
Preliminary	First Production	Datasheet contains preliminary data; supplementary data will be published at a later date. Fairchild Semiconductor reserves the right to make changes at any time without notice to improve design.
No Identification Needed	Full Production	Datasheet contains final specifications. Fairchild Semiconductor reserves the right to make changes at any time without notice to improve the design.
Obsolete	Not In Production	Datasheet contains specifications on a product that is discontinued by Fairchild Semiconductor. The datasheet is for reference information only.

Rev. I77

# Mouser Electronics

Authorized Distributor

Click to View Pricing, Inventory, Delivery & Lifecycle Information:

[Fairchild Semiconductor:](#)

[FPF1504UCX](#) [FPF1504BUCX](#)