

FQP17N40

N-Channel QFET® MOSFET

400 V, 16 A, 270 mΩ

Description

This N-Channel enhancement mode power MOSFET is produced using Fairchild Semiconductor's proprietary planar stripe and DMOS technology. This advanced MOSFET technology has been especially tailored to reduce on-state resistance, and to provide superior switching performance and high avalanche energy strength. These devices are suitable for switched mode power supplies, active power factor correction (PFC), and electronic lamp ballasts.

Features

- 16 A, 400 V, $R_{DS(on)} = 270 \text{ m}\Omega$ (Max.) @ $V_{GS} = 10 \text{ V}$, $I_D = 8.0 \text{ A}$
- Low Gate Charge (Typ. 45 nC)
- Low Crss (Typ. 30 pF)
- 100% Avalanche Tested

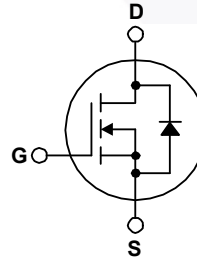
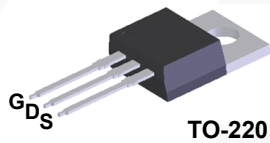

Absolute Maximum Ratings $T_C = 25^\circ\text{C}$ unless otherwise noted.

Symbol	Parameter	FQP17N40	Unit
V_{DSS}	Drain-Source Voltage	400	V
I_D	Drain Current - Continuous ($T_C = 25^\circ\text{C}$) - Continuous ($T_C = 100^\circ\text{C}$)	16	A
		10.1	A
I_{DM}	Drain Current - Pulsed (Note 1)	64	A
V_{GSS}	Gate-Source Voltage	± 30	V
E_{AS}	Single Pulsed Avalanche Energy (Note 2)	1000	mJ
I_{AR}	Avalanche Current (Note 1)	16	A
E_{AR}	Repetitive Avalanche Energy (Note 1)	17	mJ
dv/dt	Peak Diode Recovery dv/dt (Note 3)	4.5	V/ns
P_D	Power Dissipation ($T_C = 25^\circ\text{C}$) - Derate above 25°C	170	W
		1.35	W/ $^\circ\text{C}$
T_J, T_{STG}	Operating and Storage Temperature Range	-55 to +150	$^\circ\text{C}$
T_L	Maximum Lead Temperature for Soldering, 1/8" from Case for 5 seconds	300	$^\circ\text{C}$

Thermal Characteristics

Symbol	Parameter	FQP17N40	Unit
$R_{\theta JC}$	Thermal Resistance, Junction-to-Case, Max.	0.74	$^\circ\text{C}/\text{W}$
$R_{\theta JA}$	Thermal Resistance, Junction-to-Ambient, Max.	62.5	$^\circ\text{C}/\text{W}$

Package Marking and Ordering Information

Part Number	Top Mark	Package	Packing Method	Reel Size	Tape Width	Quantity
FQP17N40	FQP17N40	TO-220	Tube	N/A	N/A	50 units

Electrical Characteristics

$T_C = 25^\circ\text{C}$ unless otherwise noted.

Symbol	Parameter	Test Conditions	Min	Typ	Max	Unit
--------	-----------	-----------------	-----	-----	-----	------

Off Characteristics

BV_{DSS}	Drain-Source Breakdown Voltage	$V_{GS} = 0\text{ V}, I_D = 250\ \mu\text{A}$	400	--	--	V
$\Delta BV_{DSS} / \Delta T_J$	Breakdown Voltage Temperature Coefficient	$I_D = 250\ \mu\text{A}$, Referenced to 25°C	--	0.44	--	V/ $^\circ\text{C}$
I_{DSS}	Zero Gate Voltage Drain Current	$V_{DS} = 400\text{ V}, V_{GS} = 0\text{ V}$	--	--	1	μA
		$V_{DS} = 320\text{ V}, T_C = 125^\circ\text{C}$	--	--	10	μA
I_{GSSF}	Gate-Body Leakage Current, Forward	$V_{GS} = 30\text{ V}, V_{DS} = 0\text{ V}$	--	--	100	nA
I_{GSSR}	Gate-Body Leakage Current, Reverse	$V_{GS} = -30\text{ V}, V_{DS} = 0\text{ V}$	--	--	-100	nA

On Characteristics

$V_{GS(th)}$	Gate Threshold Voltage	$V_{DS} = V_{GS}, I_D = 250\ \mu\text{A}$	3.0	--	5.0	V
$R_{DS(on)}$	Static Drain-Source On-Resistance	$V_{GS} = 10\text{ V}, I_D = 8.0\text{ A}$	--	0.21	0.27	Ω
g_{FS}	Forward Transconductance	$V_{DS} = 50\text{ V}, I_D = 8.0\text{ A}$	--	13	--	S

Dynamic Characteristics

C_{iss}	Input Capacitance	$V_{DS} = 25\text{ V}, V_{GS} = 0\text{ V},$ $f = 1.0\text{ MHz}$	--	1800	2300	pF
C_{oss}	Output Capacitance		--	270	350	pF
C_{rss}	Reverse Transfer Capacitance		--	30	40	pF

Switching Characteristics

$t_{d(on)}$	Turn-On Delay Time	$V_{DD} = 200\text{ V}, I_D = 17.2\text{ A},$ $R_G = 25\ \Omega$	--	40	90	ns	
t_r	Turn-On Rise Time		--	185	380	ns	
$t_{d(off)}$	Turn-Off Delay Time		(Note 4)	--	90	190	ns
t_f	Turn-Off Fall Time		(Note 4)	--	105	220	ns
Q_g	Total Gate Charge	$V_{DS} = 320\text{ V}, I_D = 17.2\text{ A},$ $V_{GS} = 10\text{ V}$	--	45	60	nC	
Q_{gs}	Gate-Source Charge		(Note 4)	--	11.4	--	nC
Q_{gd}	Gate-Drain Charge		(Note 4)	--	21.7	--	nC

Drain-Source Diode Characteristics and Maximum Ratings

I_S	Maximum Continuous Drain-Source Diode Forward Current	--	--	16	A	
I_{SM}	Maximum Pulsed Drain-Source Diode Forward Current	--	--	64	A	
V_{SD}	Drain-Source Diode Forward Voltage	$V_{GS} = 0\text{ V}, I_S = 16\text{ A}$	--	--	1.5	V
t_{rr}	Reverse Recovery Time	$V_{GS} = 0\text{ V}, I_S = 17.2\text{ A},$ $di_F / dt = 100\text{ A}/\mu\text{s}$	--	290	--	ns
Q_{rr}	Reverse Recovery Charge		--	2.5	--	μC

Notes:

1. Repetitive Rating : Pulse width limited by maximum junction temperature.
2. $L = 6.8\text{ mH}, I_{AS} = 16\text{ A}, V_{DD} = 50\text{ V}, R_G = 25\ \Omega$, starting $T_J = 25^\circ\text{C}$.
3. $I_{SD} \leq 17.2\text{ A}, di/dt \leq 200\text{ A}/\mu\text{s}, V_{DD} \leq BV_{DSS}$, starting $T_J = 25^\circ\text{C}$.
4. Essentially independent of operating temperature.

Typical Characteristics

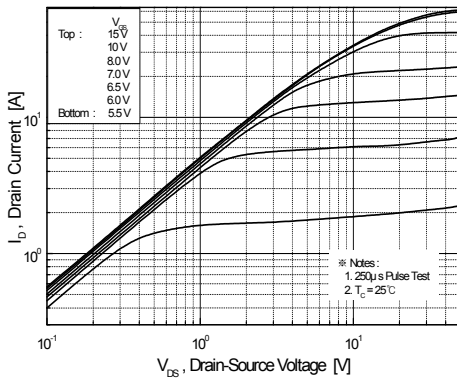

Figure 1. On-Region Characteristics

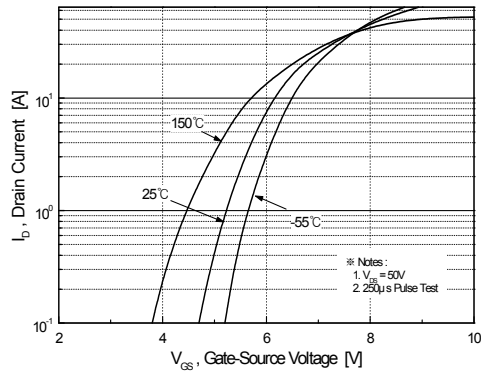

Figure 2. Transfer Characteristics

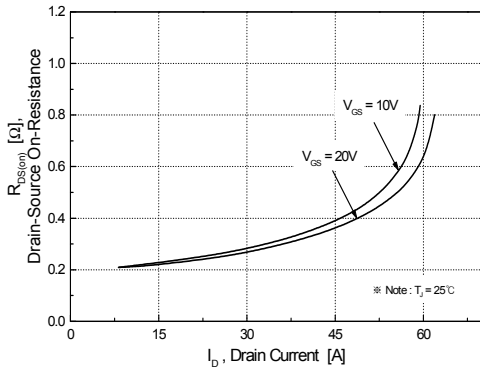

Figure 3. On-Resistance Variation vs. Drain Current and Gate Voltage

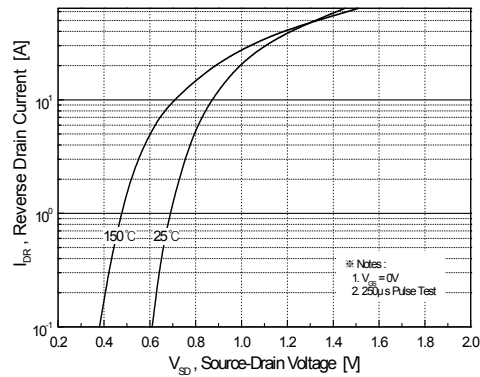

Figure 4. Body Diode Forward Voltage Variation vs. Source Current and Temperature

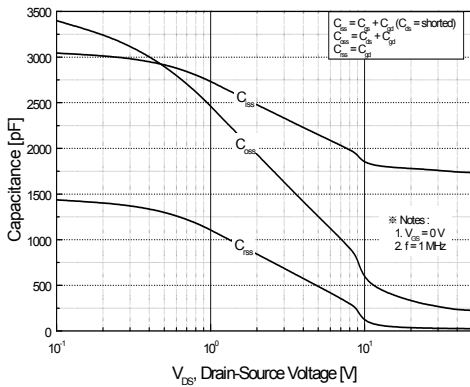

Figure 5. Capacitance Characteristics

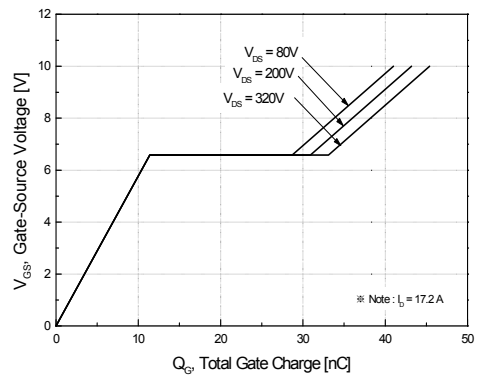

Figure 6. Gate Charge Characteristics

Typical Characteristics (continued)

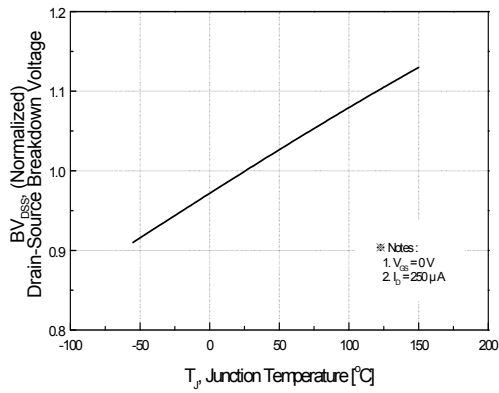

Figure 7. Breakdown Voltage Variation vs. Temperature

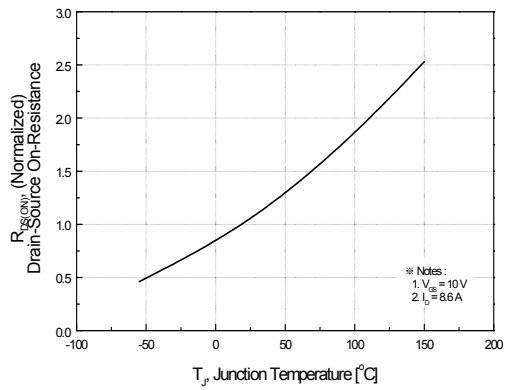

Figure 8. On-Resistance Variation vs. Temperature

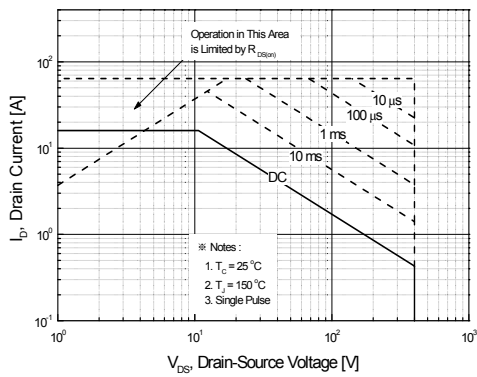

Figure 9. Maximum Safe Operating Area

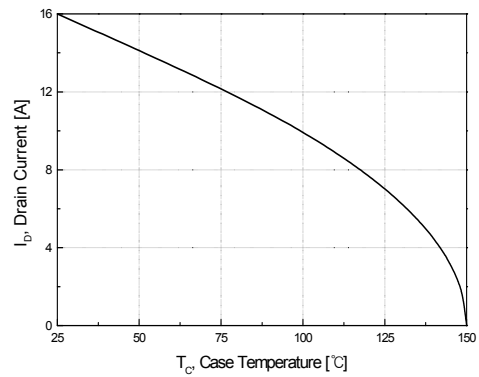

Figure 10. Maximum Drain Current vs. Case Temperature

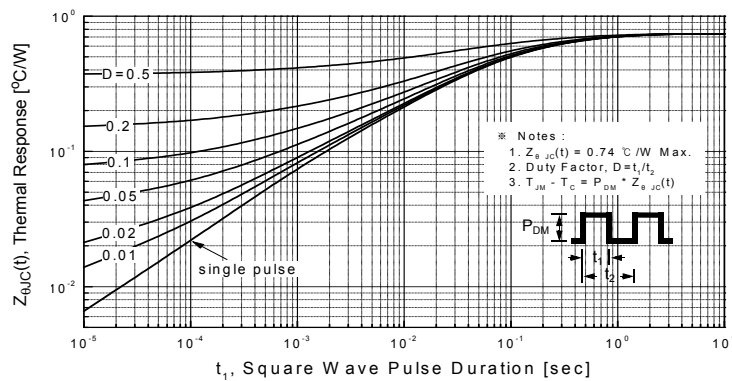

Figure 11. Transient Thermal Response Curve



Figure 12. Gate Charge Test Circuit & Waveform



Figure 13. Resistive Switching Test Circuit & Waveforms



Figure 14. Unclamped Inductive Switching Test Circuit & Waveforms



Figure 15. Peak Diode Recovery dv/dt Test Circuit & Waveforms

Mechanical Dimensions

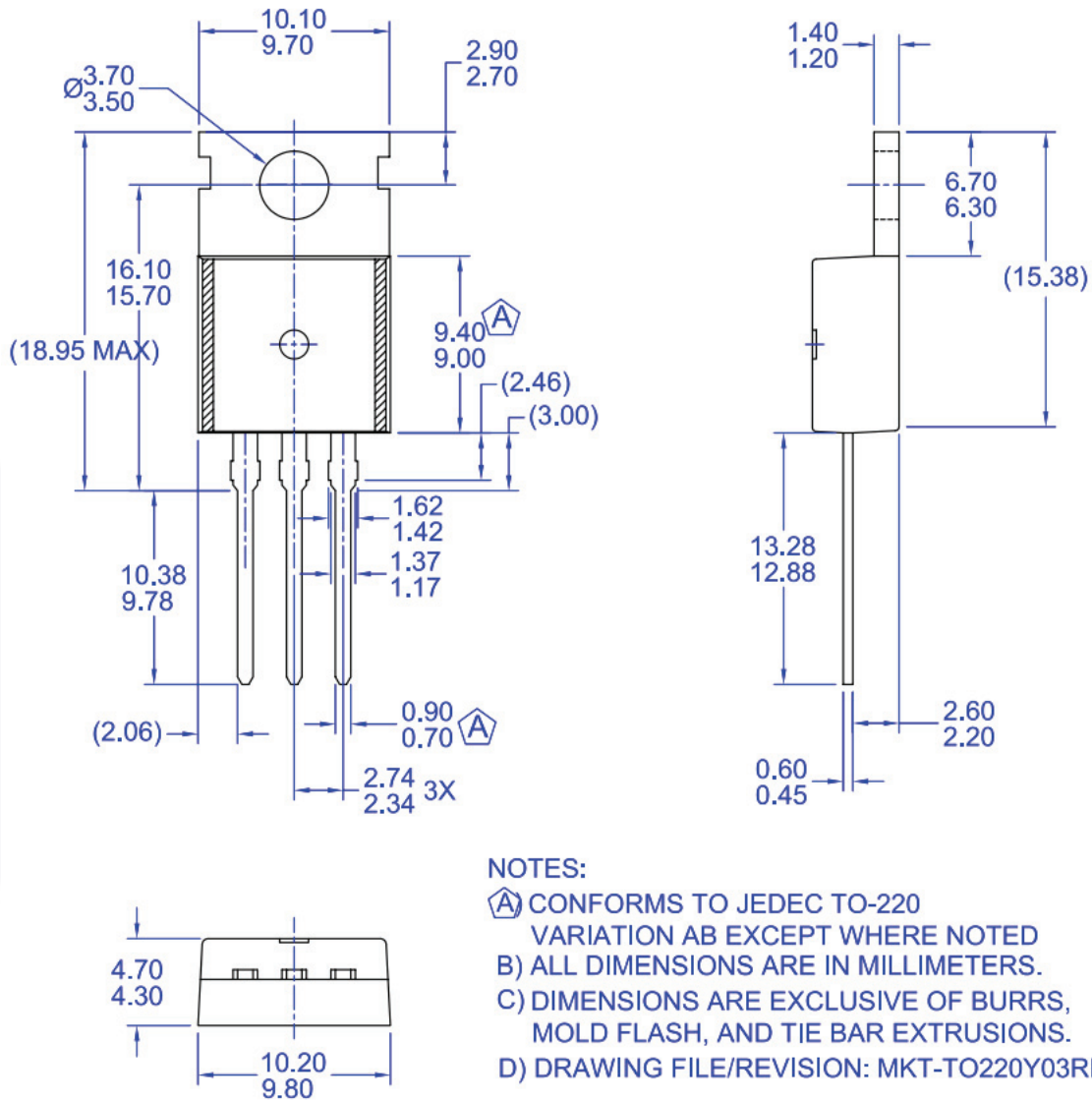

Figure 16. TO220, Molded, 3-Lead, Jedec Variation AB

Package drawings are provided as a service to customers considering Fairchild components. Drawings may change in any manner without notice. Please note the revision and/or date on the drawing and contact a Fairchild Semiconductor representative to verify or obtain the most recent revision. Package specifications do not expand the terms of Fairchild's worldwide terms and conditions, specifically the warranty therein, which covers Fairchild products.

Always visit Fairchild Semiconductor's online packaging area for the most recent package drawings:

http://www.fairchildsemi.com/package/packageDetails.html?id=PN_TO220-003



TRADEMARKS

The following includes registered and unregistered trademarks and service marks, owned by Fairchild Semiconductor and/or its global subsidiaries, and is not intended to be an exhaustive list of all such trademarks.

- | | | |
|--------------------------|---|--------------------------|
| AccuPower™ | F-PFS™ | Sync-Lock™ |
| AX-CAP®* | FRFET® | SYSTEM GENERAL ®* |
| BitSiC™ | Global Power Resource SM | TinyBoost® |
| Build it Now™ | GreenBridge™ | TinyBuck® |
| CorePLUS™ | Green FPS™ | TinyCalc™ |
| CorePOWER™ | Green FPS™ e-Series™ | TinyLogic® |
| CROSSVOLT™ | Gmax™ | TINYOPTO™ |
| CTL™ | GTO™ | TinyPower™ |
| Current Transfer Logic™ | IntelliMAX™ | TinyPWM™ |
| DEUXPEED® | ISOPLANAR™ | TinyWire™ |
| Dual Cool™ | Marking Small Speakers Sound Louder and Better™ | TranSiC™ |
| EcoSPARK® | MegaBuck™ | TriFault Detect™ |
| EfficientMax™ | MICROCOUPLER™ | TRUECURRENT®* |
| ESBC™ | MicroFET™ | µSerDes™ |
| F ® | MicroPak™ | µSerDes ™ |
| Fairchild® | MicroPak2™ | UHC® |
| Fairchild Semiconductor® | MillerDrive™ | Ultra FRFET™ |
| FACT Quiet Series™ | MotionMax™ | UniFET™ |
| FACT® | mWSaver® | VCX™ |
| FAST® | OptoHiT™ | VisualMax™ |
| FastvCore™ | OPTOLOGIC® | VoltagePlus™ |
| FETBench™ | OPTOPLANAR® | XS™ |
| FPS™ | | |
| | PowerTrench® | |
| | PowerXS™ | |
| | Programmable Active Droop™ | |
| | QFET® | |
| | QS™ | |
| | Quiet Series™ | |
| | RapidConfigure™ | |
| | Saving our world, 1mW/W/kW at a time™ | |
| | SignalWise™ | |
| | SmartMax™ | |
| | SMART START™ | |
| | Solutions for Your Success™ | |
| | SPM® | |
| | STEALTH™ | |
| | SuperFET® | |
| | SuperSOT™-3 | |
| | SuperSOT™-6 | |
| | SuperSOT™-8 | |
| | SupreMOS® | |
| | SyncFET™ | |

*Trademarks of System General Corporation, used under license by Fairchild Semiconductor.

DISCLAIMER

FAIRCHILD SEMICONDUCTOR RESERVES THE RIGHT TO MAKE CHANGES WITHOUT FURTHER NOTICE TO ANY PRODUCTS HEREIN TO IMPROVE RELIABILITY, FUNCTION, OR DESIGN. FAIRCHILD DOES NOT ASSUME ANY LIABILITY ARISING OUT OF THE APPLICATION OR USE OF ANY PRODUCT OR CIRCUIT DESCRIBED HEREIN; NEITHER DOES IT CONVEY ANY LICENSE UNDER ITS PATENT RIGHTS, NOR THE RIGHTS OF OTHERS. THESE SPECIFICATIONS DO NOT EXPAND THE TERMS OF FAIRCHILD'S WORLDWIDE TERMS AND CONDITIONS, SPECIFICALLY THE WARRANTY THEREIN, WHICH COVERS THESE PRODUCTS.

LIFE SUPPORT POLICY

FAIRCHILD'S PRODUCTS ARE NOT AUTHORIZED FOR USE AS CRITICAL COMPONENTS IN LIFE SUPPORT DEVICES OR SYSTEMS WITHOUT THE EXPRESS WRITTEN APPROVAL OF FAIRCHILD SEMICONDUCTOR CORPORATION.

As used here in:

- Life support devices or systems are devices or systems which, (a) are intended for surgical implant into the body or (b) support or sustain life, and (c) whose failure to perform when properly used in accordance with instructions for use provided in the labeling, can be reasonably expected to result in a significant injury of the user.
- A critical component in any component of a life support, device, or system whose failure to perform can be reasonably expected to cause the failure of the life support device or system, or to affect its safety or effectiveness.

ANTI-COUNTERFEITING POLICY

Fairchild Semiconductor Corporation's Anti-Counterfeiting Policy. Fairchild's Anti-Counterfeiting Policy is also stated on our external website, www.Fairchildsemi.com, under Sales Support. Counterfeiting of semiconductor parts is a growing problem in the industry. All manufactures of semiconductor products are experiencing counterfeiting of their parts. Customers who inadvertently purchase counterfeit parts experience many problems such as loss of brand reputation, substandard performance, failed application, and increased cost of production and manufacturing delays. Fairchild is taking strong measures to protect ourselves and our customers from the proliferation of counterfeit parts. Fairchild strongly encourages customers to purchase Fairchild parts either directly from Fairchild or from Authorized Fairchild Distributors who are listed by country on our web page cited above. Products customers buy either from Fairchild directly or from Authorized Fairchild Distributors are genuine parts, have full traceability, meet Fairchild's quality standards for handling and storage and provide access to Fairchild's full range of up-to-date technical and product information. Fairchild and our Authorized Distributors will stand behind all warranties and will appropriately address and warranty issues that may arise. Fairchild will not provide any warranty coverage or other assistance for parts bought from Unauthorized Sources. Fairchild is committed to combat this global problem and encourage our customers to do their part in stopping this practice by buying direct or from authorized distributors.

PRODUCT STATUS DEFINITIONS

Definition of Terms

Datasheet Identification	Product Status	Definition
Advance Information	Formative / In Design	Datasheet contains the design specifications for product development. Specifications may change in any manner without notice.
Preliminary	First Production	Datasheet contains preliminary data; supplementary data will be published at a later date. Fairchild Semiconductor reserves the right to make changes at any time without notice to improve design.
No Identification Needed	Full Production	Datasheet contains final specifications. Fairchild Semiconductor reserves the right to make changes at any time without notice to improve the design.
Obsolete	Not In Production	Datasheet contains specifications on a product that is discontinued by Fairchild Semiconductor. The datasheet is for reference information only.

Rev. I66

Mouser Electronics

Authorized Distributor

Click to View Pricing, Inventory, Delivery & Lifecycle Information:

[Fairchild Semiconductor:](#)

[FQP17N40](#)