



November 2014

D44H8 / NZT44H8 NPN Power Amplifier

Features

- This device is designed for power amplifier, regulator and switching circuits where speed is important.
- Sourced from process 4Q.

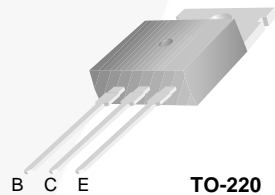

Figure 1. D44H8 Device Package

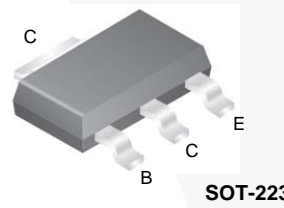

Figure 2. NZT44H8 Device Package

Ordering Information

Part Number	Marking	Package	Packing Method
D44H8	D44H8	TO-220 3L	Rail
NZT44H8	44H8	SOT-223 4L	Tape and Reel

Absolute Maximum Ratings^{(1),(2)}

Stresses exceeding the absolute maximum ratings may damage the device. The device may not function or be operable above the recommended operating conditions and stressing the parts to these levels is not recommended. In addition, extended exposure to stresses above the recommended operating conditions may affect device reliability. The absolute maximum ratings are stress ratings only. Values are at $T_A = 25^\circ\text{C}$ unless otherwise noted.

Symbol	Parameter	Value	Unit
V_{CEO}	Collector-Emitter Voltage	60	V
I_C	Collector Current - Continuous	8.0	A
T_J, T_{STG}	Operating and Storage Junction Temperature Range	-55 to +150	$^\circ\text{C}$

Notes:

1. These ratings are based on a maximum junction temperature of 150°C .
2. These are steady-state limits. Fairchild Semiconductor should be consulted on applications involving pulsed or low-duty-cycle operations.

Thermal Characteristics⁽³⁾

Values are at $T_A = 25^\circ\text{C}$ unless otherwise noted.

Symbol	Parameter	Max.		Unit
		D44H8	NZT44H8	
P_D	Total Device Dissipation	60	1.5	W
	Derate Above 25°C	480	12	mW/ $^\circ\text{C}$
$R_{\theta\text{JC}}$	Thermal Resistance, Junction-to-Case	2.1		$^\circ\text{C}/\text{W}$
$R_{\theta\text{JA}}$	Thermal Resistance, Junction-to-Ambient	62.5	83.3	$^\circ\text{C}/\text{W}$

Note:

3. PCB size: FR-4, 76 mm x 114 mm x 1.57 mm (3.0 inch x 4.5 inch x 0.062 inch) with minimum land pattern size.

Electrical Characteristics

Values are at $T_A = 25^\circ\text{C}$ unless otherwise noted.

Symbol	Parameter	Conditions	Min.	Max.	Unit
$V_{(\text{BR})\text{CEO}}$	Collector-Emitter Breakdown Voltage	$I_C = 100 \text{ mA}, I_B = 0$	60		V
I_{CBO}	Collector-Base Cut-Off Current	$V_{\text{CB}} = 60 \text{ V}, I_E = 0$		10	μA
I_{EBO}	Emitter-Base Cut-Off Current	$V_{\text{EB}} = 5 \text{ V}, I_C = 0$		100	μA
h_{FE}	DC Current Gain	$V_{\text{CE}} = 1 \text{ V}, I_C = 2 \text{ A}$	60		
		$V_{\text{CE}} = 1 \text{ V}, I_C = 4 \text{ A}$	40		
$V_{\text{CE(sat)}}$	Collector-Emitter Saturation Voltage	$I_C = 8 \text{ A}, I_B = 0.4 \text{ A}$		1.0	V
$V_{\text{BE(sat)}}$	Base-Emitter Saturation Voltage	$I_C = 8 \text{ A}, I_B = 0.8 \text{ A}$		1.5	V
$V_{\text{BE(on)}}$	Base-Emitter On Voltage	$V_{\text{CE}} = 2 \text{ V}, I_C = 10 \text{ mA}$	0.52	0.65	V
f_T	Current Gain-Bandwidth Product	$I_C = 500 \text{ mA}, V_{\text{CE}} = 10 \text{ V}$	50		MHz

Typical Performance Characteristics

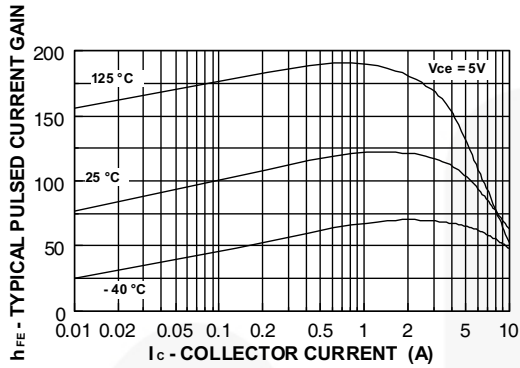

Figure 3. Typical Pulsed Current Gain vs. Collector Current

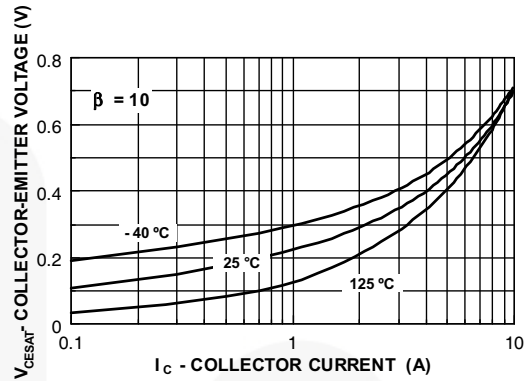

Figure 4. Collector-Emitter Saturation Voltage vs. Collector Current

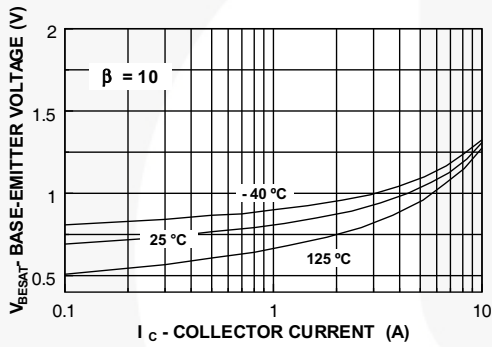

Figure 5. Base-Emitter Saturation Voltage vs. Collector Current

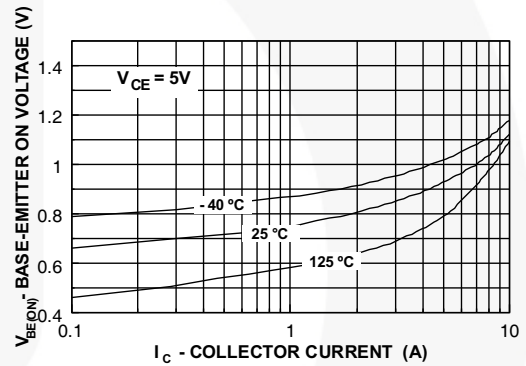

Figure 6. Base-Emitter On Voltage vs. Collector Current

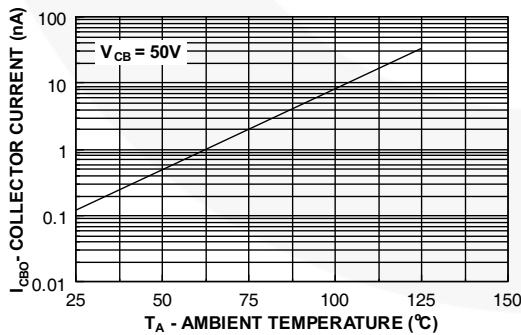

Figure 7. Current Cut-Off Current vs. Ambient Temperature

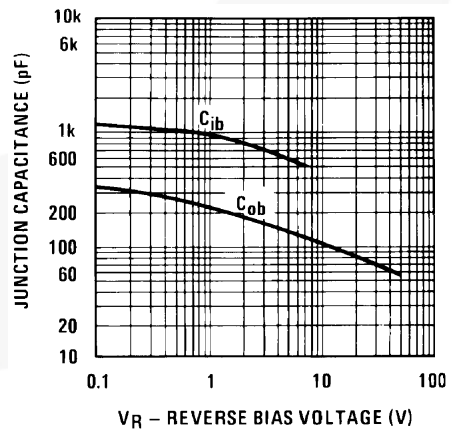

Figure 8. Junction Capacitance vs. Reverse Bias Voltage

Typical Performance Characteristics (Continued)

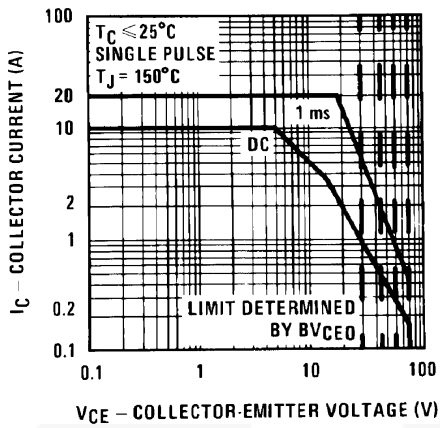

Figure 9. Safe Operating Area TO-220

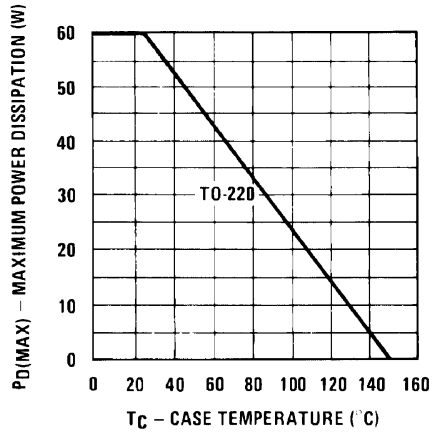

Figure 10. Maximum Power Dissipation vs. Case Temperature

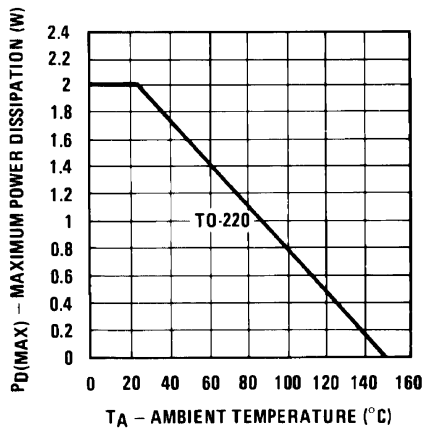

Figure 11. Maximum Power Dissipation vs. Ambient Temperature

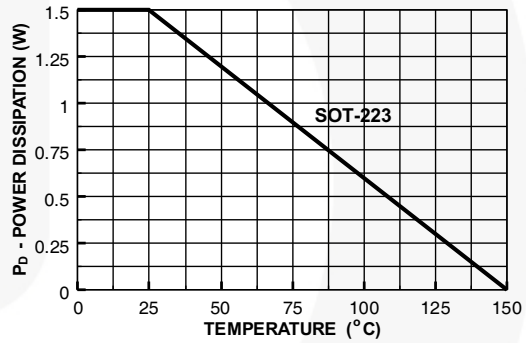

Figure 12. Power Dissipation vs. Ambient Temperature

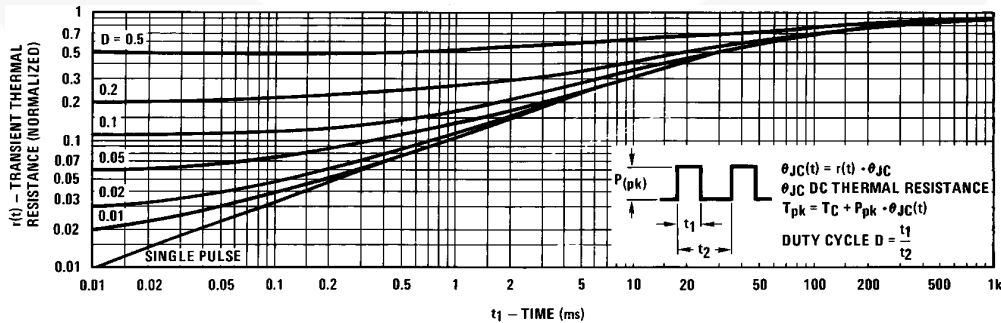
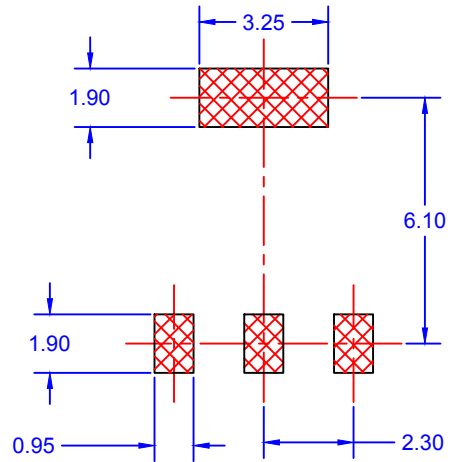
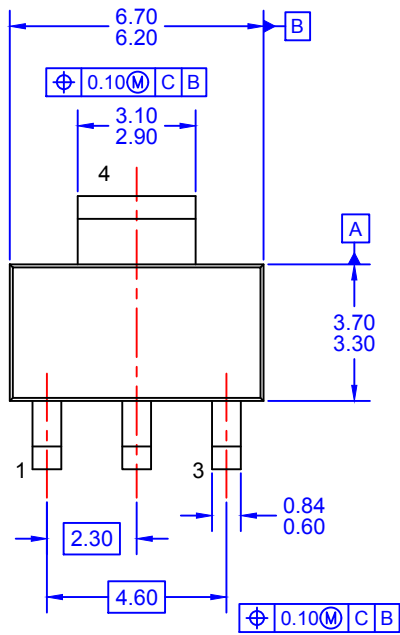
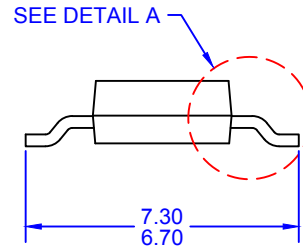
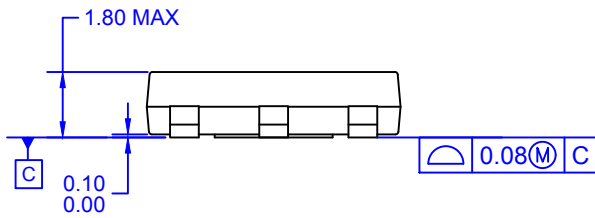

Figure 13. Thermal Response in TO-220 Package



LAND PATTERN RECOMMENDATION



- NOTES: UNLESS OTHERWISE SPECIFIED
 A) DRAWING BASED ON JEDEC REGISTRATION TO-261C, VARIATION AA.
 B) ALL DIMENSIONS ARE IN MILLIMETERS.
 C) DIMENSIONS DO NOT INCLUDE BURRS OR MOLD FLASH. MOLD FLASH OR BURRS DOES NOT EXCEED 0.10MM.
 D) DIMENSIONING AND TOLERANCING PER ASME Y14.5M-2009.
 E) LANDPATTERN NAME: SOT230P700X180-4BN
 F) DRAWING FILENAME: MKT-MA04AREV3

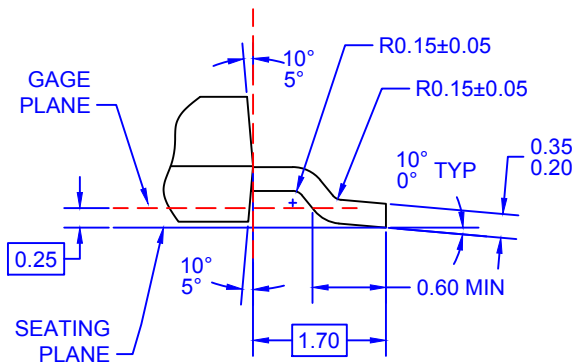

DETAIL A
SCALE: 2:1







TRADEMARKS

The following includes registered and unregistered trademarks and service marks, owned by Fairchild Semiconductor and/or its global subsidiaries, and is not intended to be an exhaustive list of all such trademarks.

- AccuPower™
- AttitudeEngine™
- Awinda®
- AX-CAP®*
- BitSiC™
- Build it Now™
- CorePLUS™
- CorePOWER™
- CROSSVOL™
- CTL™
- Current Transfer Logic™
- DEUXPEED®
- Dual Cool™
- EcoSPARK®
- EfficientMax™
- ESBC™
- F**™
- Fairchild®
- Fairchild Semiconductor®
- FACT Quiet Series™
- FACT®
- FastvCore™
- FETBench™
- FPS™
- F-PFS™
- FRFET®
- Global Power ResourceSM
- GreenBridge™
- Green FPS™
- Green FPS™ e-Series™
- Gmax™
- GTO™
- IntelliMAX™
- ISOPLANAR™
- Making Small Speakers Sound Louder and Better™
- MegaBuck™
- MICROCOUPLER™
- MicroFET™
- MicroPak™
- MicroPak2™
- MillerDrive™
- MotionMax™
- MotionGrid®
- MTi®
- MTx®
- MVN®
- mWSaver®
- OptoHiT™
- OPTOLOGIC®
- OPTOPLANAR®
- ®
- Power Supply WebDesigner™
- PowerTrench®
- PowerXS™
- Programmable Active Droop™
- QFET®
- QS™
- Quiet Series™
- RapidConfigure™
- ™
- Saving our world, 1mW/W/kW at a time™
- SignalWise™
- SmartMax™
- SMART START™
- Solutions for Your Success™
- SPM®
- STEALTH™
- SuperFET®
- SuperSOT™-3
- SuperSOT™-6
- SuperSOT™-8
- SupreMOS®
- SyncFET™
- Sync-Lock™
- ®
- TinyBoost®
- TinyBuck®
- TinyCalc™
- TinyLogic®
- TINYOPTO™
- TinyPower™
- TinyPWM™
- TinyWire™
- TranSiC™
- TriFault Detect™
- TRUECURRENT®*
- μSerDes™
- ™
- UHC®
- Ultra FRFET™
- UniFET™
- VcX™
- VisualMax™
- VoltagePlus™
- XS™
- Xsens™
- 仙童®

* Trademarks of System General Corporation, used under license by Fairchild Semiconductor.

DISCLAIMER

FAIRCHILD SEMICONDUCTOR RESERVES THE RIGHT TO MAKE CHANGES WITHOUT FURTHER NOTICE TO ANY PRODUCTS HEREIN TO IMPROVE RELIABILITY, FUNCTION, OR DESIGN. TO OBTAIN THE LATEST, MOST UP-TO-DATE DATASHEET AND PRODUCT INFORMATION, VISIT OUR WEBSITE AT [HTTP://WWW.FAIRCHILDSEMI.COM](http://www.fairchildsemi.com). FAIRCHILD DOES NOT ASSUME ANY LIABILITY ARISING OUT OF THE APPLICATION OR USE OF ANY PRODUCT OR CIRCUIT DESCRIBED HEREIN; NEITHER DOES IT CONVEY ANY LICENSE UNDER ITS PATENT RIGHTS, NOR THE RIGHTS OF OTHERS. THESE SPECIFICATIONS DO NOT EXPAND THE TERMS OF FAIRCHILD'S WORLDWIDE TERMS AND CONDITIONS, SPECIFICALLY THE WARRANTY THEREIN, WHICH COVERS THESE PRODUCTS.

AUTHORIZED USE

Unless otherwise specified in this data sheet, this product is a standard commercial product and is not intended for use in applications that require extraordinary levels of quality and reliability. This product may not be used in the following applications, unless specifically approved in writing by a Fairchild officer: (1) automotive or other transportation, (2) military/aerospace, (3) any safety critical application – including life critical medical equipment – where the failure of the Fairchild product reasonably would be expected to result in personal injury, death or property damage. Customer's use of this product is subject to agreement of this Authorized Use policy. In the event of an unauthorized use of Fairchild's product, Fairchild accepts no liability in the event of product failure. In other respects, this product shall be subject to Fairchild's Worldwide Terms and Conditions of Sale, unless a separate agreement has been signed by both Parties.

ANTI-COUNTERFEITING POLICY

Fairchild Semiconductor Corporation's Anti-Counterfeiting Policy. Fairchild's Anti-Counterfeiting Policy is also stated on our external website, www.fairchildsemi.com, under Terms of Use

Counterfeiting of semiconductor parts is a growing problem in the industry. All manufacturers of semiconductor products are experiencing counterfeiting of their parts. Customers who inadvertently purchase counterfeit parts experience many problems such as loss of brand reputation, substandard performance, failed applications, and increased cost of production and manufacturing delays. Fairchild is taking strong measures to protect ourselves and our customers from the proliferation of counterfeit parts. Fairchild strongly encourages customers to purchase Fairchild parts either directly from Fairchild or from Authorized Fairchild Distributors who are listed by country on our web page cited above. Products customers buy either from Fairchild directly or from Authorized Fairchild Distributors are genuine parts, have full traceability, meet Fairchild's quality standards for handling and storage and provide access to Fairchild's full range of up-to-date technical and product information. Fairchild and our Authorized Distributors will stand behind all warranties and will appropriately address any warranty issues that may arise. Fairchild will not provide any warranty coverage or other assistance for parts bought from Unauthorized Sources. Fairchild is committed to combat this global problem and encourage our customers to do their part in stopping this practice by buying direct or from authorized distributors.

PRODUCT STATUS DEFINITIONS

Definition of Terms

Datasheet Identification	Product Status	Definition
Advance Information	Formative / In Design	Datasheet contains the design specifications for product development. Specifications may change in any manner without notice.
Preliminary	First Production	Datasheet contains preliminary data; supplementary data will be published at a later date. Fairchild Semiconductor reserves the right to make changes at any time without notice to improve design.
No Identification Needed	Full Production	Datasheet contains final specifications. Fairchild Semiconductor reserves the right to make changes at any time without notice to improve the design.
Obsolete	Not In Production	Datasheet contains specifications on a product that is discontinued by Fairchild Semiconductor. The datasheet is for reference information only.

Rev. I77

Mouser Electronics

Authorized Distributor

Click to View Pricing, Inventory, Delivery & Lifecycle Information:

[Fairchild Semiconductor:](#)

[Nzt44h8](#)