

IRF7326D2

FETKY™ MOSFET / Schottky Diode

- Co-packaged HEXFET® Power MOSFET and Schottky Diode
- Ideal For Buck Regulator Applications
- P-Channel HEXFET
- Low V_F Schottky Rectifier
- Generation 5 Technology
- SO-8 Footprint

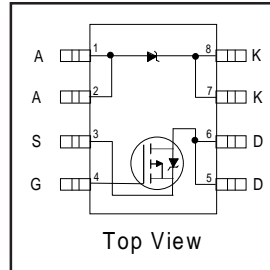

$V_{DSS} = -30V$
$R_{DS(on)} = 0.10\Omega$
Schottky $V_f = 0.52V$

Description

The **FETKY** family of co-packaged MOSFETs and Schottky diodes offers the designer an innovative, board space saving solution for switching regulator and power management applications. Generation 5 HEXFET Power MOSFETs utilize advanced processing techniques to achieve extremely low on-resistance per silicon area. Combining this technology with International Rectifier's low forward drop Schottky rectifiers results in an extremely efficient device suitable for use in a wide variety of portable electronics applications.

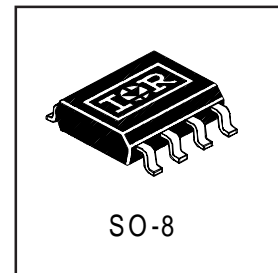

The SO-8 has been modified through a customized leadframe for enhanced thermal characteristics. The SO-8 package is designed for vapor phase, infrared or wave soldering techniques.

Absolute Maximum Ratings ($T_A = 25^\circ C$ unless otherwise noted)

Parameter		Maximum	Units
$I_D @ T_A = 25^\circ C$	Continuous Drain Current ④	-3.6	A
$I_D @ T_A = 70^\circ C$		-2.9	
I_{DM}	Pulsed Drain Current ①	-29	
$P_D @ T_A = 25^\circ C$	Power Dissipation ④	2.0	W
$P_D @ T_A = 70^\circ C$		1.3	
	Linear Derating Factor	16	mW/°C
V_{GS}	Gate-to-Source Voltage	± 20	V
dv/dt	Peak Diode Recovery dv/dt ②	-5.0	V/ns
T_J, T_{STG}	Junction and Storage Temperature Range	-55 to +150	°C

Thermal Resistance Ratings

Parameter		Maximum	Units
$R_{\theta JA}$	Junction-to-Ambient ④	62.5	°C/W

Notes:

- ① Repetitive rating; pulse width limited by maximum junction temperature (see figure 9)
- ② $I_{SD} \leq -1.8A$, $di/dt \leq -90A/\mu s$, $V_{DD} \leq V_{(BR)DSS}$, $T_J \leq 150^\circ C$
- ③ Pulse width $\leq 300\mu s$; duty cycle $\leq 2\%$
- ④ Surface mounted on FR-4 board, $t \leq 10sec$.

MOSFET Electrical Characteristics @ T_J = 25°C (unless otherwise specified)

Parameter		Min.	Typ.	Max.	Units	Conditions
V _{(BR)DSS}	Drain-to-Source Breakdown Voltage	-30	—	—	V	V _{GS} = 0V, I _D = -250μA
R _{DS(on)}	Static Drain-to-Source On-Resistance	—	0.073	0.10	Ω	V _{GS} = -10V, I _D = -1.8A ③
		—	0.13	0.16		V _{GS} = -4.5V, I _D = -1.5A ③
V _{GS(th)}	Gate Threshold Voltage	-1.0	—	—	V	V _{DS} = V _{GS} , I _D = -250μA
g _{fs}	Forward Transconductance	2.5	—	—	S	V _{DS} = -24V, I _D = -1.8A
I _{DSS}	Drain-to-Source Leakage Current	—	—	-1.0	μA	V _{DS} = -24V, V _{GS} = 0V
		—	—	-25		V _{DS} = -24V, V _{GS} = 0V, T _J = 55°C
I _{GSS}	Gate-to-Source Forward Leakage	—	—	100	nA	V _{GS} = -20V
	Gate-to-Source Reverse Leakage	—	—	-100		V _{GS} = 20V
Q _g	Total Gate Charge	—	—	25	nC	I _D = -1.8A
Q _{gs}	Gate-to-Source Charge	—	—	2.9		V _{DS} = -24V
Q _{gd}	Gate-to-Drain ("Miller") Charge	—	—	9.0		V _{GS} = -10V (see figure 6) ③
t _{d(on)}	Turn-On Delay Time	—	11	—	ns	V _{DD} = -15V
t _r	Rise Time	—	17	—		I _D = -1.8A
t _{d(off)}	Turn-Off Delay Time	—	25	—		R _G = 6.0Ω
t _f	Fall Time	—	18	—		R _D = 8.2Ω ③
C _{iss}	Input Capacitance	—	440	—	pF	V _{GS} = 0V
C _{oss}	Output Capacitance	—	200	—		V _{DS} = -25V
C _{rss}	Reverse Transfer Capacitance	—	93	—		f = 1.0MHz (see figure 5)

MOSFET Source-Drain Ratings and Characteristics

Parameter		Min.	Typ.	Max.	Units	Conditions
I _S	Continuous Source Current (Body Diode)	—	—	-2.5	A	
I _{SM}	Pulsed Source Current (Body Diode)	—	—	-29		
V _{SD}	Body Diode Forward Voltage	—	—	-1.0	V	T _J = 25°C, I _S = -1.8A, V _{GS} = 0V
t _{rr}	Reverse Recovery Time (Body Diode)	—	53	80	ns	T _J = 25°C, I _F = -1.8A
Q _{rr}	Reverse Recovery Charge	—	66	99	nC	di/dt = 100A/μs ③

Schottky Diode Maximum Ratings

	Parameter	Max.	Units	Conditions
I _{f(av)}	Max. Average Forward Current	2.8	A	50% Duty Cycle. Rectangular Wave, T _c = 25°C
		1.8		50% Duty Cycle. Rectangular Wave, T _c = 70°C
I _{SM}	Max. peak one cycle Non-repetitive Surge current	200	A	5μs sine or 3μs Rect. pulse
		20		10ms sine or 6ms Rect. pulse
				Following any rated load condition & with V _{rrm} applied

Schottky Diode Electrical Specifications

	Parameter	Max.	Units	Conditions
V _{fm}	Max. Forward voltage drop	0.57	V	I _f = 3.0, T _J = 25°C
		0.77		I _f = 6.0, T _J = 25°C
		0.52		I _f = 3.0, T _J = 125°C
		0.79		I _f = 6.0, T _J = 125°C
I _{rm}	Max. Reverse Leakage current	0.30	mA	V _r = 30V, T _J = 25°C
		37		T _J = 125°C
C _t	Max. Junction Capacitance	310	pF	V _r = 5Vdc (100kHz to 1 MHz) 25°C
dv/dt	Max. Voltage Rate of Charge	4900	V/μs	Rated V _r

(HEXFET is the reg. TM for International Rectifier Power MOSFET's)

Power Mosfet Characteristics

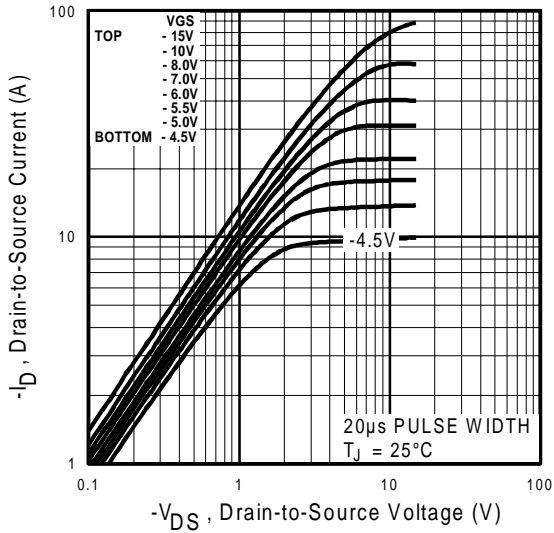

Fig 1. Typical Output Characteristics

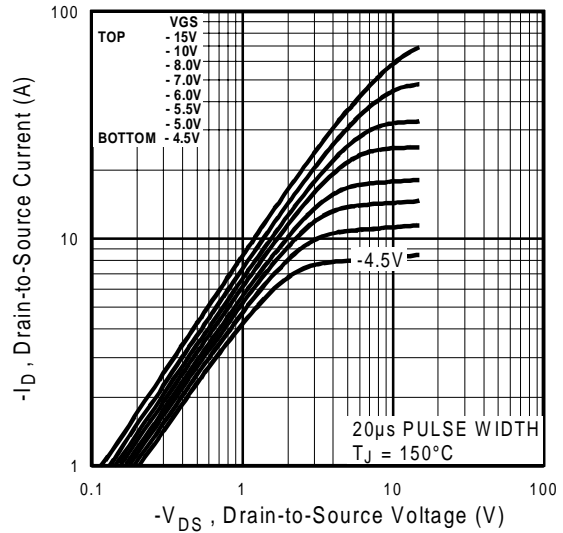

Fig 2. Typical Output Characteristics

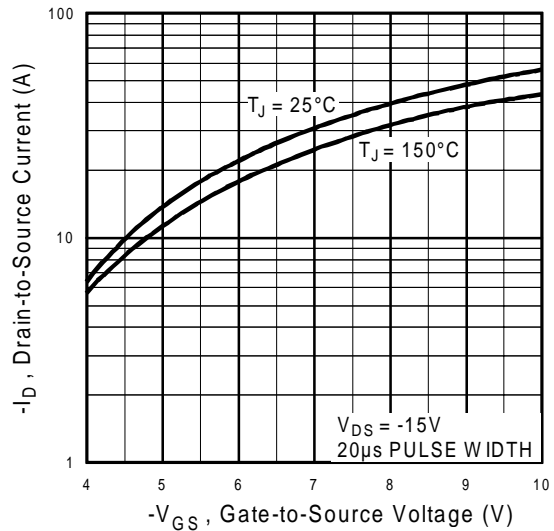

Fig 3. Typical Transfer Characteristics

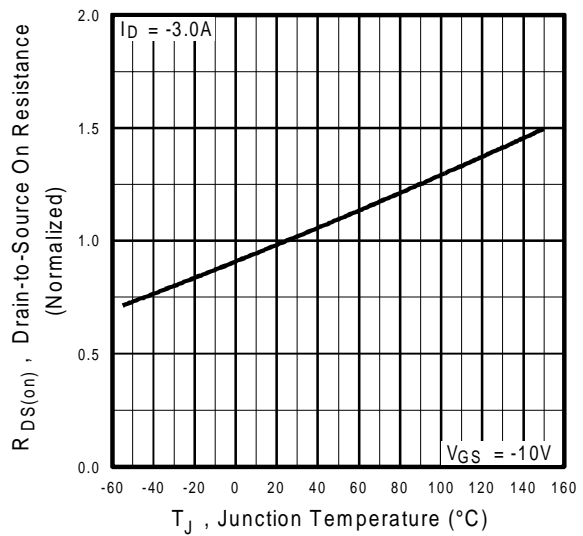

Fig 4. Normalized On-Resistance Vs. Temperature

Power Mosfet Characteristics

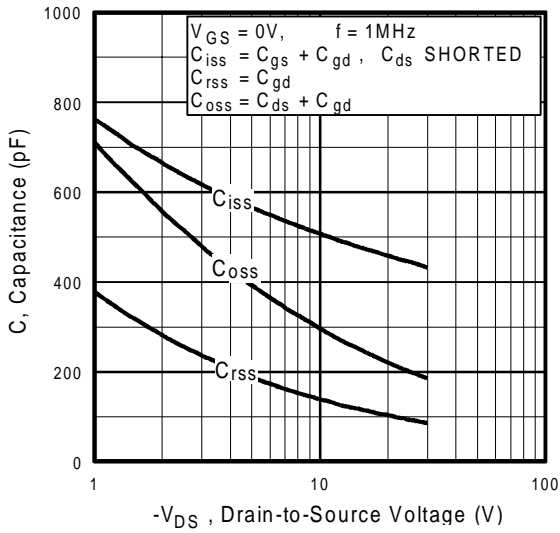

Fig 5. Typical Capacitance Vs. Drain-to-Source Voltage

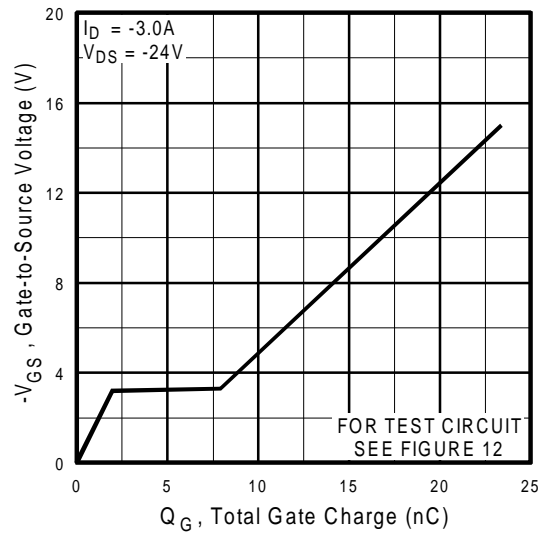

Fig 6. Typical Gate Charge Vs. Gate-to-Source Voltage

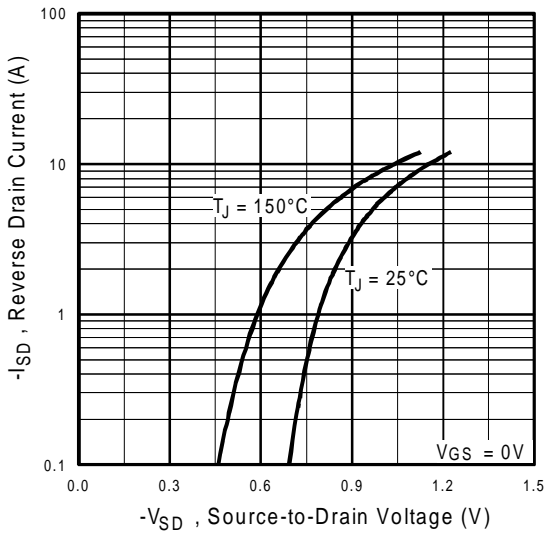

Fig 7. Typical Source-Drain Diode Forward Voltage

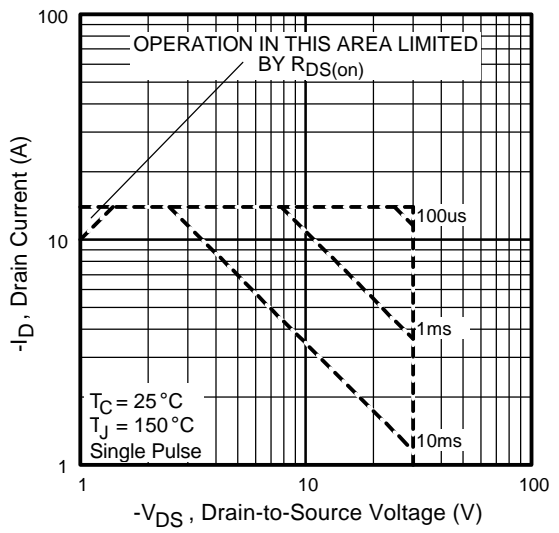

Fig 8. Maximum Safe Operating Area

Power Mosfet Characteristics

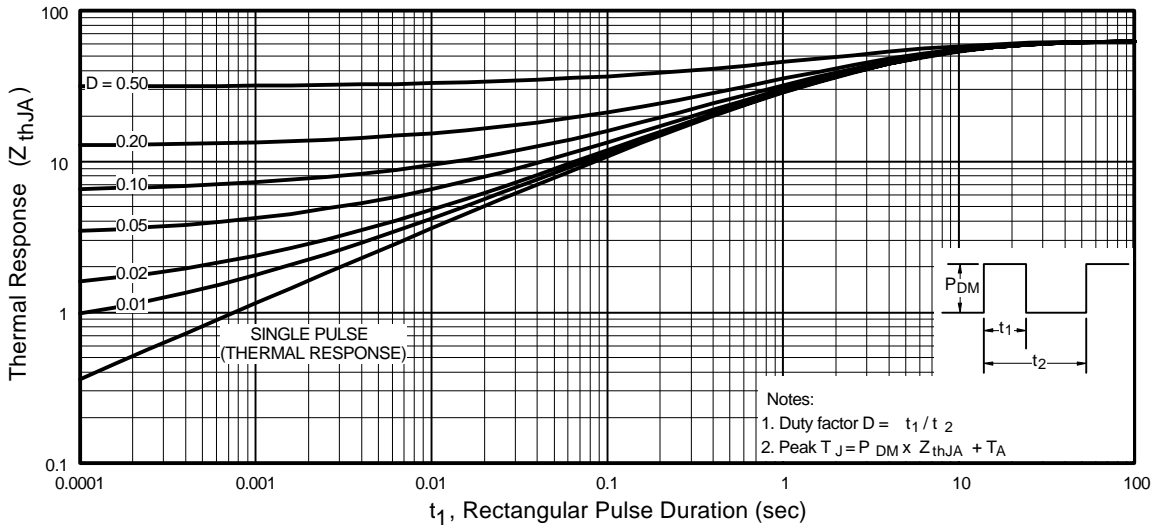

Fig 9. Maximum Effective Transient Thermal Impedance, Junction-to-Ambient

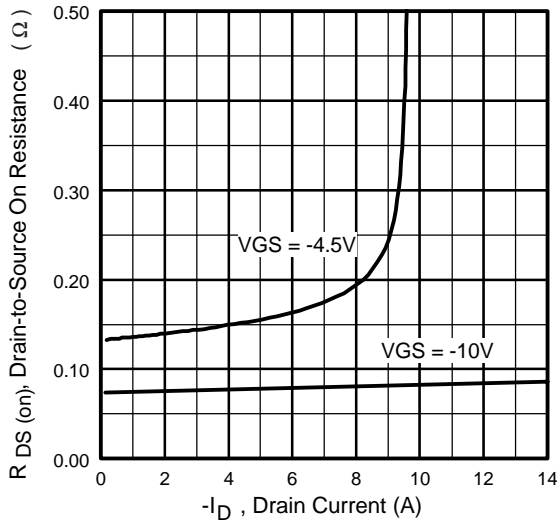

Fig 10. Typical On-Resistance Vs. Drain Current

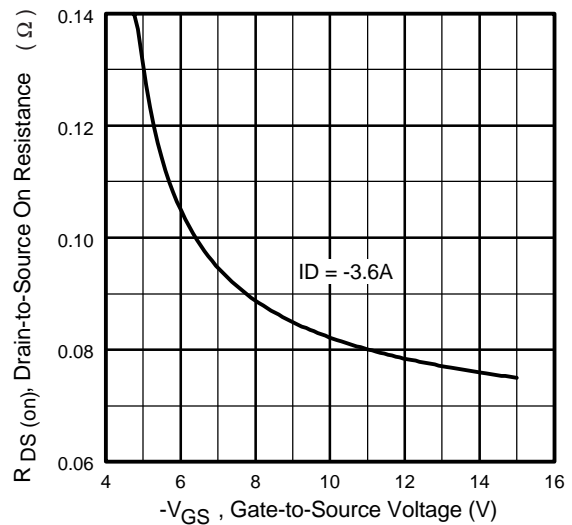

Fig 11. Typical On-Resistance Vs. Gate Voltage

Schottky Diode Characteristics

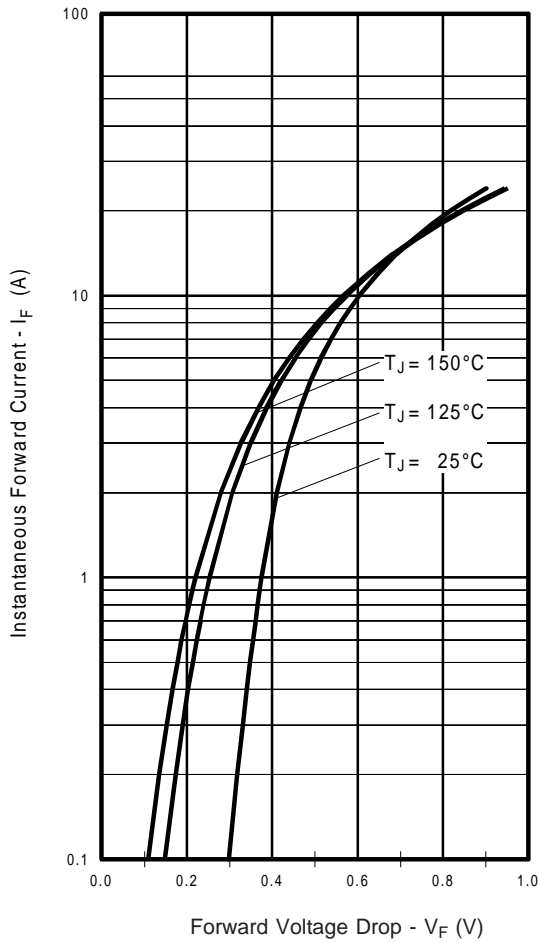

Fig. 12 - Typical Forward Voltage Drop Characteristics

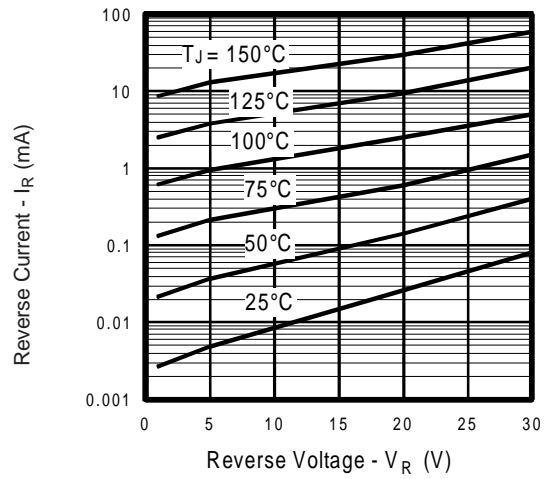

Fig. 13 - Typical Values of Reverse Current Vs. Reverse Voltage

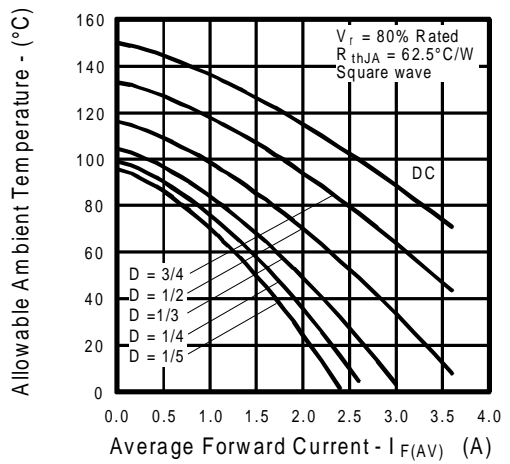
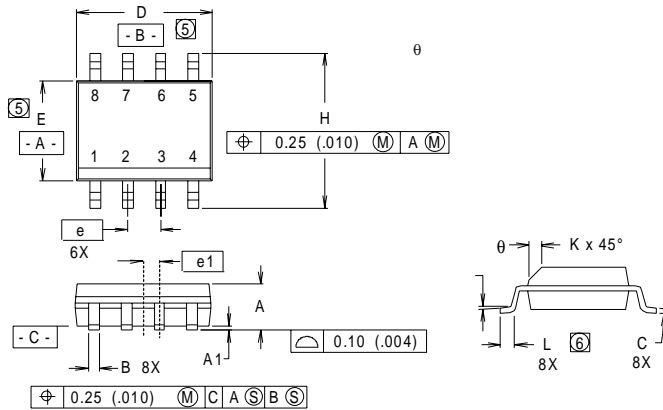

Fig.14 - Maximum Allowable Ambient Temp. Vs. Forward Current

SO-8 Package Details



DIM	INCHES		MILLIMETERS	
	MIN	MAX	MIN	MAX
A	.0532	.0688	1.35	1.75
A1	.0040	.0098	0.10	0.25
B	.014	.018	0.36	0.46
C	.0075	.0098	0.19	0.25
D	.189	.196	4.80	4.98
E	.150	.157	3.81	3.99
e	.050 BASIC		1.27 BASIC	
e1	.025 BASIC		0.635 BASIC	
H	.2284	.2440	5.80	6.20
K	.011	.019	0.28	0.48
L	0.16	.050	0.41	1.27
θ	0°	8°	0°	8°

RECOMMENDED FOOTPRINT

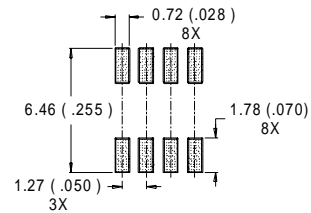

NOTES:

1. DIMENSIONING AND TOLERANCING PER ANSI Y14.5M-1982.
2. CONTROLLING DIMENSION : INCH.
3. DIMENSIONS ARE SHOWN IN MILLIMETERS (INCHES).
4. OUTLINE CONFORMS TO JEDEC OUTLINE MS-012AA.
5. DIMENSION DOES NOT INCLUDE MOLD PROTRUSIONS
MOLD PROTRUSIONS NOT TO EXCEED 0.25 (.006).
6. DIMENSIONS IS THE LENGTH OF LEAD FOR SOLDERING TO A SUBSTRATE..

Part Marking (IRF7101 example)

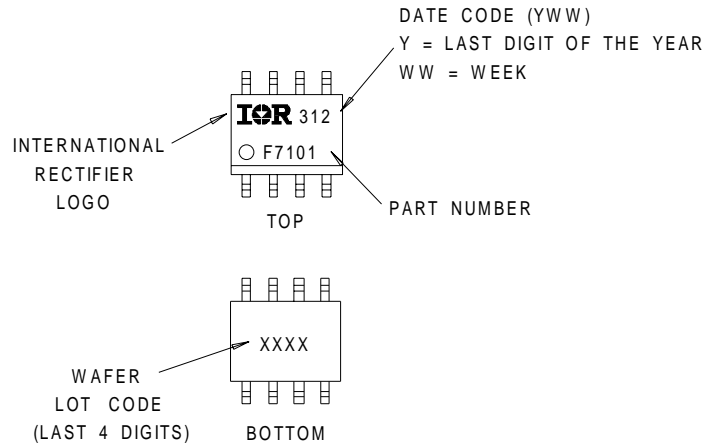

IRF7326D2

Tape and Reel

International
IR Rectifier

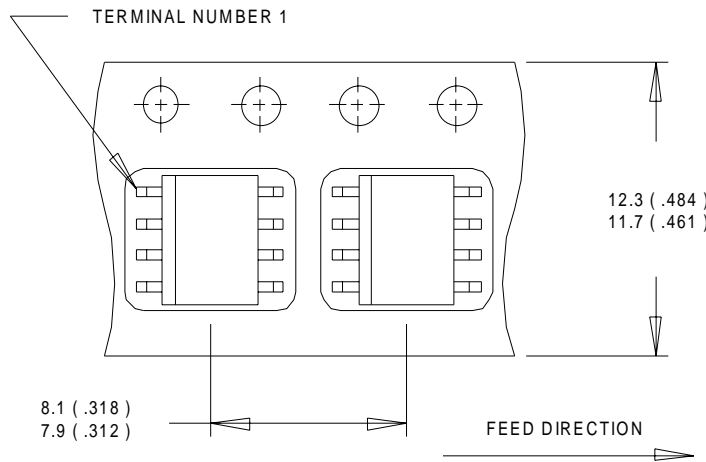

NOTES:

1. CONTROLLING DIMENSION : MILLIMETER.
2. ALL DIMENSIONS ARE SHOWN IN MILLIMETERS(INCHES).
3. OUTLINE CONFORMS TO EIA-481 & EIA-541.

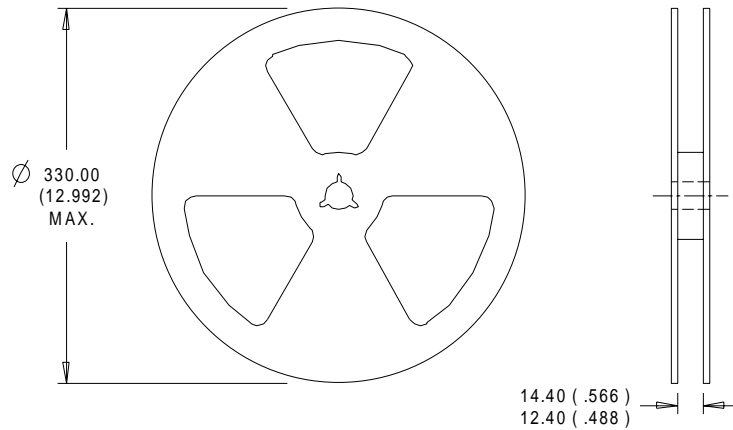

NOTES :

1. CONTROLLING DIMENSION : MILLIMETER.
2. OUTLINE CONFORMS TO EIA-481 & EIA-541.

International
IR Rectifier

WORLD HEADQUARTERS: 233 Kansas St., El Segundo, California 90245, Tel: (310) 322 3331

IR GREAT BRITAIN: Hurst Green, Oxted, Surrey RH8 9BB, UK Tel: ++ 44 1883 732020

IR CANADA: 15 Lincoln Court, Brampton, Ontario L6T3Z2, Tel: (905) 453 2200

IR GERMANY: Saalburgstrasse 157, 61350 Bad Homburg Tel: ++ 49 6172 96590

IR ITALY: Via Liguria 49, 10071 Borgaro, Torino Tel: ++ 39 11 451 0111

IR FAR EAST: K&H Bldg., 2F, 30-4 Nishi-Ikebukuro 3-Chome, Toshima-Ku, Tokyo Japan 171 Tel: 81 3 3983 0086

IR SOUTHEAST ASIA: 1 Kim Seng Promenade, Great World City West Tower, 13-11, Singapore 237994 Tel: ++ 65 838 4630

IR TAIWAN: 16 Fl. Suite D. 207, Sec. 2, Tun Haw South Road, Taipei, 10673, Taiwan Tel: 886-2-2377-9936

<http://www.irf.com/> Data and specifications subject to change without notice. 8/99

Mouser Electronics

Authorized Distributor

Click to View Pricing, Inventory, Delivery & Lifecycle Information:

[International Rectifier:](#)

[IRF7326D2PBF](#) [IRF7326D2TRPBF](#)