

IRGS15B60KPbF

INSULATED GATE BIPOLAR TRANSISTOR

Features

- Low VCE (on) Non Punch Through IGBT Technology.
- 10 μ s Short Circuit Capability.
- Square RBSOA.
- Positive VCE (on) Temperature Coefficient.
- Lead-Free

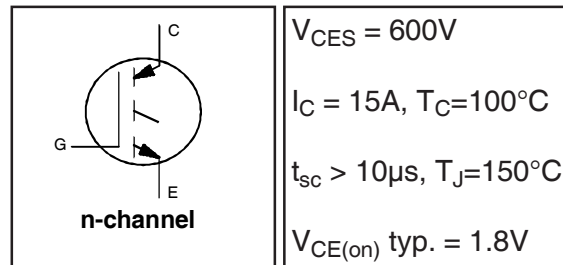

Benefits

- Benchmark Efficiency for Motor Control.
- Rugged Transient Performance.
- Low EMI.
- Excellent Current Sharing in Parallel Operation.

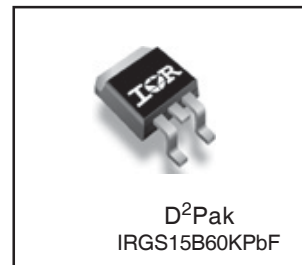

Absolute Maximum Ratings

	Parameter	Max.	Units
V_{CES}	Collector-to-Emitter Voltage	600	V
$I_C @ T_C = 25^\circ C$	Continuous Collector Current	31	A
$I_C @ T_C = 100^\circ C$	Continuous Collector Current	15	
I_{CM}	Pulse Collector Current $V_{ge} = 15V$	62	
I_{LM}	Clamped Inductive Load Current $V_{ge} = 20V$ ④	62	
V_{GE}	Continuous Gate-to-Emitter Voltage	± 20	V
$P_D @ T_C = 25^\circ C$	Maximum Power Dissipation	208	W
$P_D @ T_C = 100^\circ C$	Maximum Power Dissipation	83	
T_J	Operating Junction and	-55 to +150	$^\circ C$
T_{STG}	Storage Temperature Range		
	Soldering Temperature, for 10 sec.	300 (0.063 in. (1.6mm) from case)	

Thermal Resistance

	Parameter	Min.	Typ.	Max.	Units
$R_{\theta JC}$ (IGBT)	Junction-to-Case-IGBT	—	—	0.6	$^\circ C/W$
$R_{\theta CS}$	Case-to-Sink (flat, greased surface)	—	0.5	—	
$R_{\theta JA}$	Junction-to-Ambient (PCB Mount steady state) ①	—	—	40	
	Weight	—	1.44	—	g (oz)

IRGS15B60KPbF

Electrical Characteristics @ T_J = 25°C (unless otherwise specified)

	Parameter	Min.	Typ.	Max.	Units	Conditions	Ref.Fig
V _{(BR)CES}	Collector-to-Emitter Breakdown Voltage	600	—	—	V	V _{GE} = 0V, I _C = 500μA	
ΔV _{(BR)CES} /ΔT _J	Temperature Coeff. of Breakdown Voltage	—	0.3	—	V/°C	V _{GE} = 0V, I _C = 1.0mA (25°C-150°C)	
V _{CE(on)}	Collector-to-Emitter Saturation Voltage	1.5	1.8	2.2	V	I _C = 15A, V _{GE} = 15V, T _J = 25°C	5,6,7
		—	2.05	2.5		I _C = 15A, V _{GE} = 15V, T _J = 125°C	8,9,10
		—	2.1	2.6		I _C = 15A, V _{GE} = 15V, T _J = 150°C	
V _{GE(th)}	Gate Threshold Voltage	3.5	4.5	5.5	V	V _{CE} = V _{GE} , I _C = 250μA	8,9
ΔV _{GE(th)} /ΔT _J	Threshold Voltage temp. coefficient	—	-10	—	mV/°C	V _{CE} = V _{GE} , I _C = 1.0mA (25°C - 150°C)	10,11
g _{fe}	Forward Transconductance	—	10.6	—	S	V _{CE} = 50V, I _C = 20A, PW = 80μs	
I _{CES}	Collector-to-Emitter Leakage Current	—	5.0	150	μA	V _{GE} = 0V, V _{CE} = 600V, T _J = 25°C	
		—	500	1000		V _{GE} = 0V, V _{CE} = 600V, T _J = 150°C	
I _{GES}	Gate-to-Emitter Leakage Current	—	—	±100	nA	V _{GE} = ± 20V	

Switching Characteristics @ T_J = 25°C (unless otherwise specified)

	Parameter	Min.	Typ.	Max.	Units	Conditions	Ref.Fig
Q _g	Total Gate Charge (turn-on)	—	56	84	nC	I _C = 15A V _{GE} = 15V V _{CC} = 400V	CT1
Q _{ge}	Gate-to-Emitter Charge (turn-on)	—	7.0	10			
Q _{gc}	Gate-to-Collector Charge (turn-on)	—	26	39			
E _{on}	Turn-On Switching Loss	—	220	330	μJ	I _C = 15A, V _{CC} = 400V, V _{GE} = 15V R _G = 22Ω, L = 200μH L _S = 150nH T _J = 25°C ②	CT4
E _{off}	Turn-Off Switching Loss	—	340	455			
E _{total}	Total Switching Loss	—	560	785			
t _{d(on)}	Turn-On delay time	—	34	44	ns	I _C = 15A, V _{CC} = 400V, V _{GE} = 15V R _G = 22Ω, L = 200μH L _S = 150nH T _J = 25°C	CT4
t _r	Rise time	—	16	22			
t _{d(off)}	Turn-Off delay time	—	184	200			
t _f	Fall time	—	20	26			
E _{on}	Turn-On Switching Loss	—	355	470	μJ	I _C = 15A, V _{CC} = 400V, V _{GE} = 15V R _G = 22Ω, L = 200μH L _S = 150nH T _J = 150°C ②	CT4 12,14 WF1, WF2
E _{off}	Turn-Off Switching Loss	—	490	600			
E _{total}	Total Switching Loss	—	835	1070			
t _{d(on)}	Turn-On delay time	—	34	44	ns	I _C = 15A, V _{CC} = 400V, V _{GE} = 15V R _G = 22Ω, L = 200μH L _S = 150nH T _J = 150°C	13, 15 CT4 WF1 WF2
t _r	Rise time	—	18	25			
t _{d(off)}	Turn-Off delay time	—	203	226			
t _f	Fall time	—	28	36			
C _{ies}	Input Capacitance	—	850	—	pF	V _{GE} = 0V V _{CC} = 30V f = 1.0Mhz	
C _{oes}	Output Capacitance	—	75	—			
C _{res}	Reverse Transfer Capacitance	—	35	—			
RBSOA	Reverse Bias Safe Operating Area	FULL SQUARE				I _C = 62A V _{CC} = 500V, V _p = 600V R _G = 22Ω, V _{GE} = +20V to 0V, T _J = 150°C	4 CT2
SCSOA	Short Circuit Safe Operating Area	10	—	—	μs	V _{CC} = 360V, V _p = 600V, T _J = 150°C R _G = 22Ω, V _{GE} = +15V to 0V	CT3 WF3

Note ① to ③ are on page 11

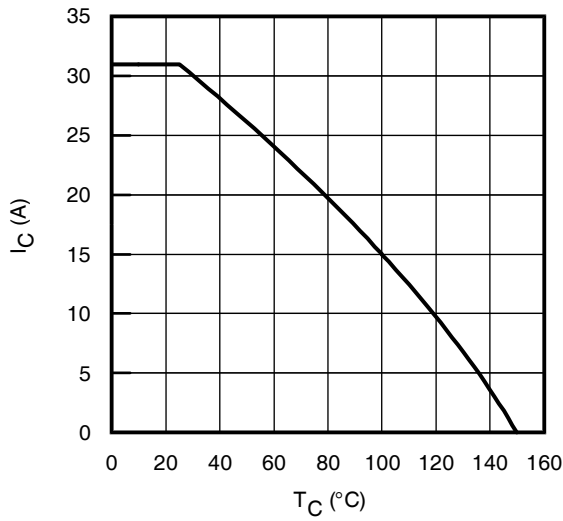

Fig. 1 - Maximum DC Collector Current vs. Case Temperature

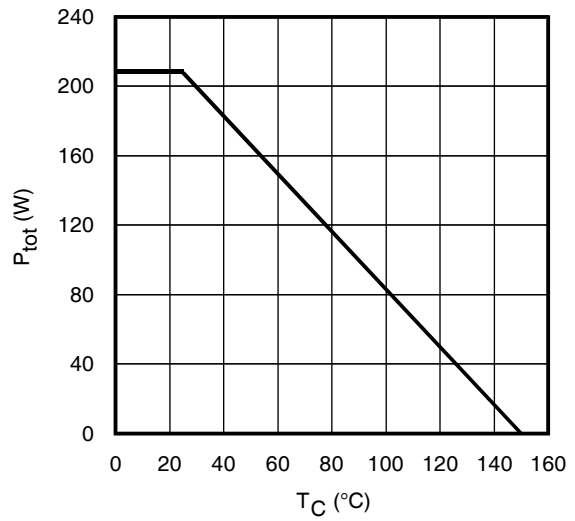

Fig. 2 - Power Dissipation vs. Case Temperature

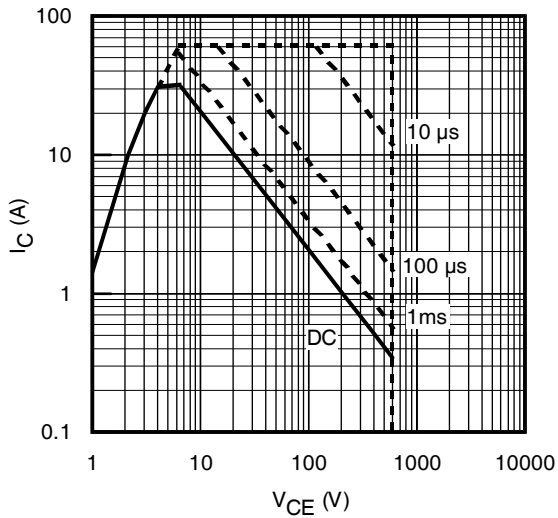

Fig. 3 - Forward SOA
 $T_C = 25^\circ\text{C}$; $T_J \leq 150^\circ\text{C}$

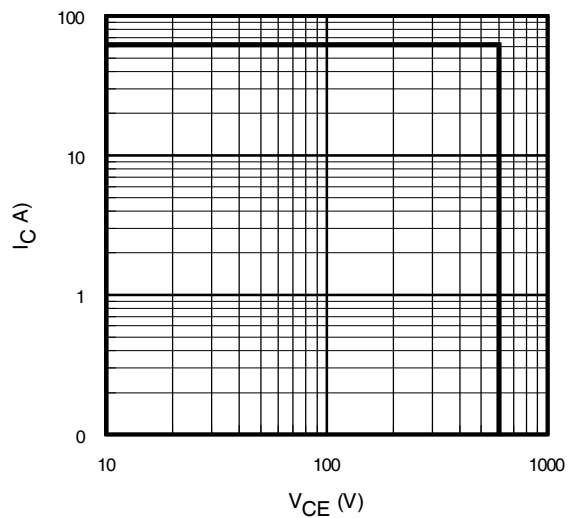

Fig. 4 - Reverse Bias SOA
 $T_J = 150^\circ\text{C}$; $V_{GE} = 15\text{V}$

IRGS15B60KPbF

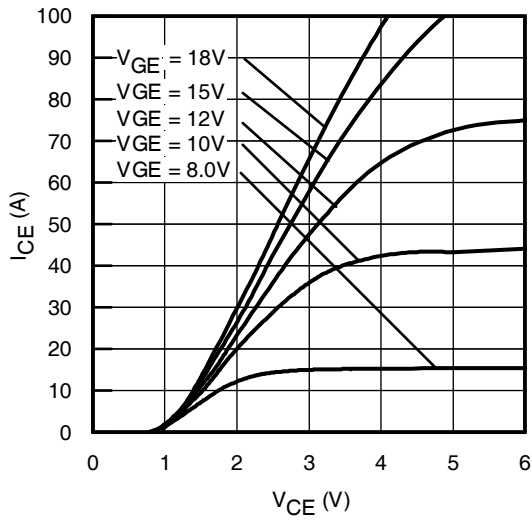

Fig. 5 - Typ. IGBT Output Characteristics
 $T_J = -40^\circ\text{C}$; $t_p = 300\mu\text{s}$

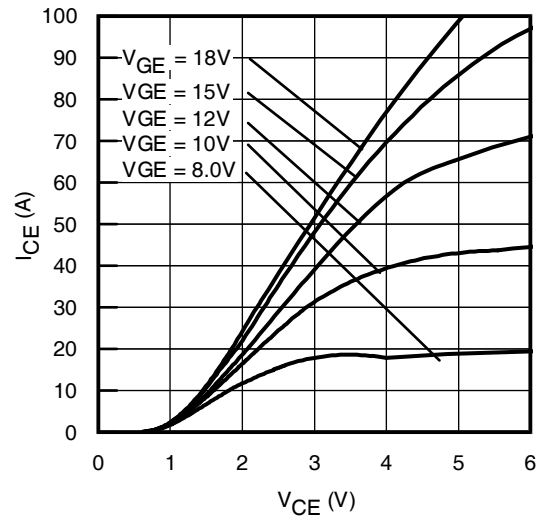

Fig. 6 - Typ. IGBT Output Characteristics
 $T_J = 25^\circ\text{C}$; $t_p = 300\mu\text{s}$

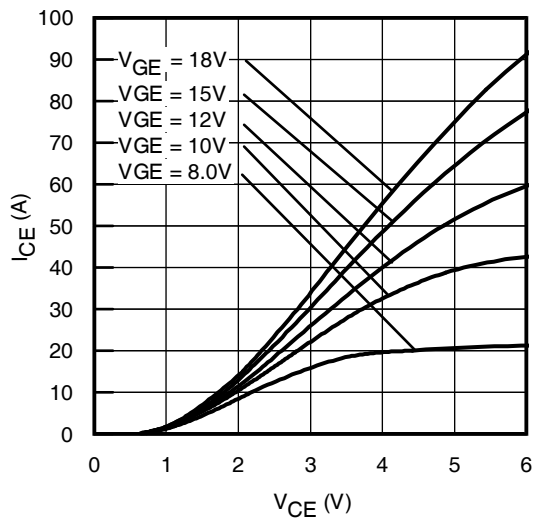

Fig. 7 - Typ. IGBT Output Characteristics
 $T_J = 150^\circ\text{C}$; $t_p = 300\mu\text{s}$

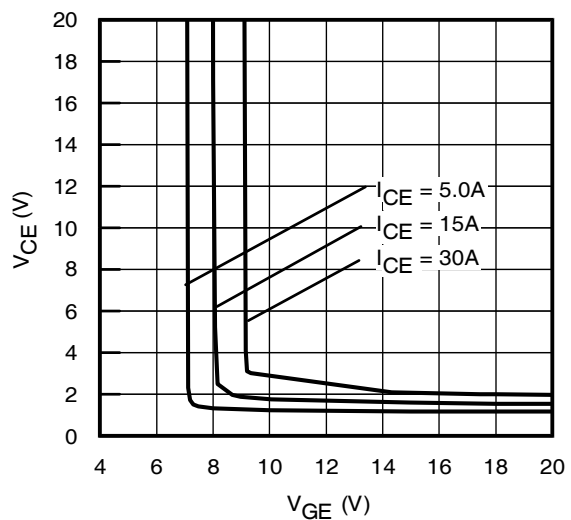

Fig. 8 - Typical V_{CE} vs. V_{GE}
 $T_J = -40^\circ\text{C}$

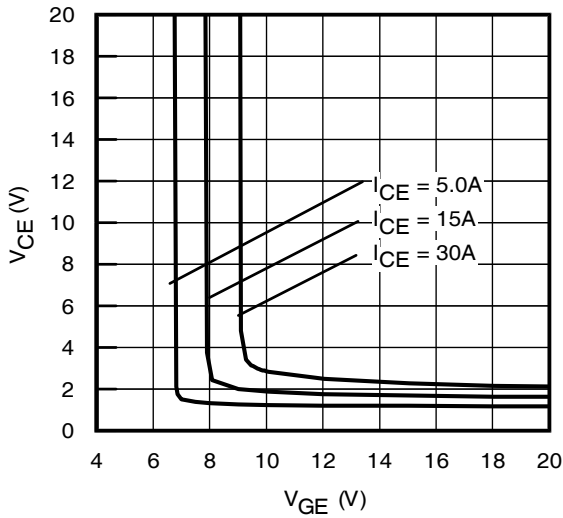

Fig. 9 - Typical V_{CE} vs. V_{GE}
 $T_J = 25^\circ\text{C}$

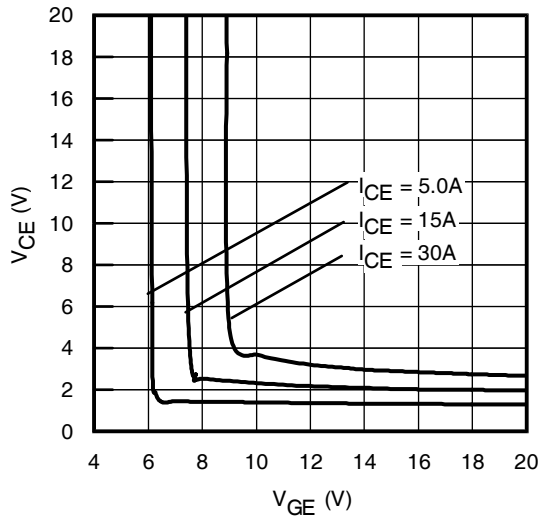

Fig. 10 - Typical V_{CE} vs. V_{GE}
 $T_J = 150^\circ\text{C}$

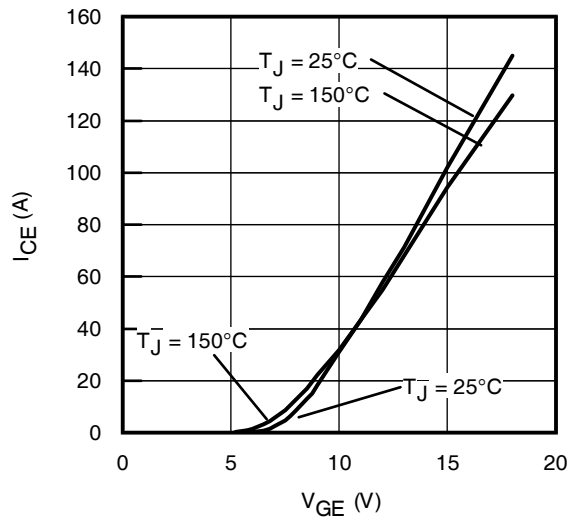

Fig. 11 - Typ. Transfer Characteristics
 $V_{CE} = 50\text{V}$; $t_p = 10\mu\text{s}$

IRGS15B60KPbF

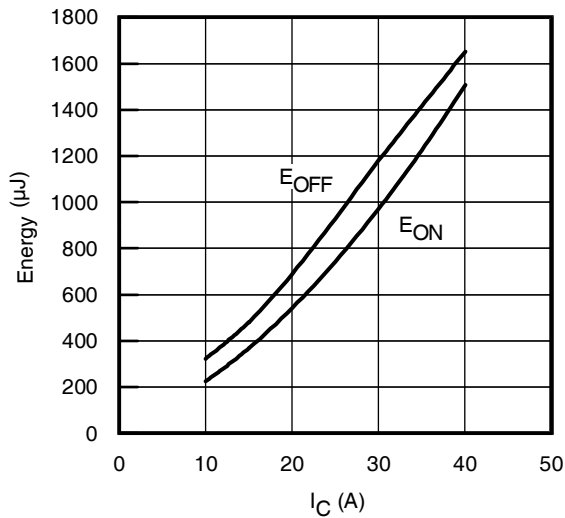

Fig. 12 - Typ. Energy Loss vs. I_C
T_J = 150°C; L=200μH; V_{CE}= 400V
R_G= 22Ω; V_{GE}= 15V

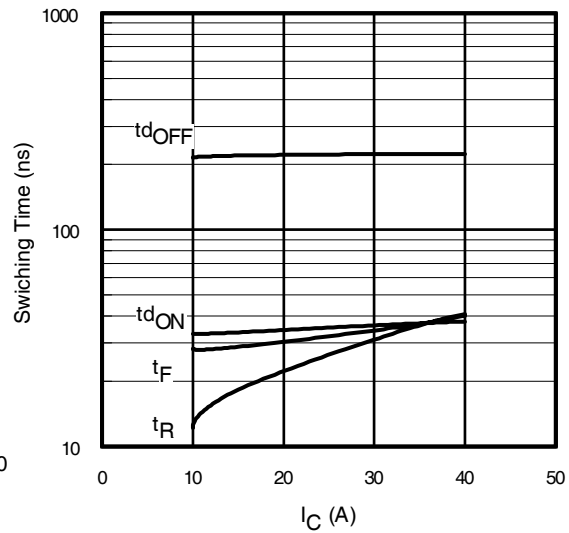

Fig. 13 - Typ. Switching Time vs. I_C
T_J = 150°C; L=200μH; V_{CE}= 400V
R_G= 22Ω; V_{GE}= 15V

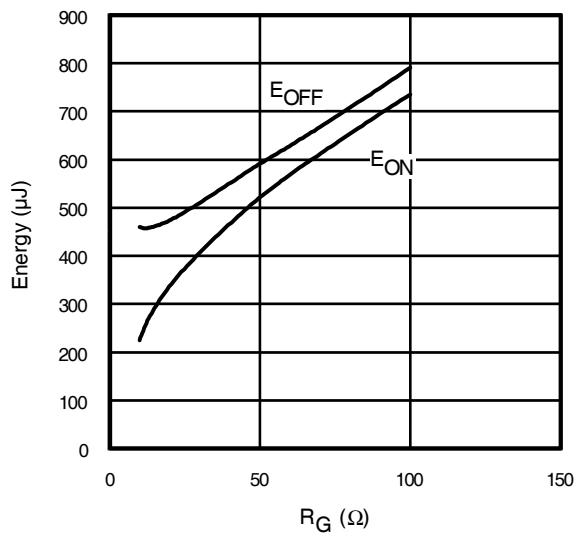

Fig. 14 - Typ. Energy Loss vs. R_G
T_J = 150°C; L=200μH; V_{CE}= 400V
I_{CE}= 15A; V_{GE}= 15V

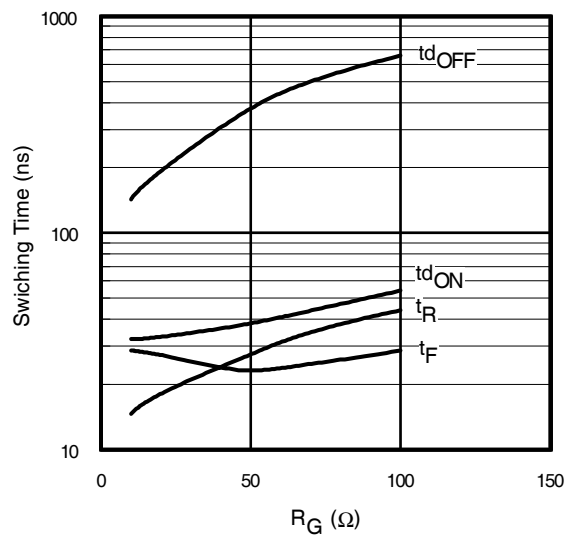

Fig. 15 - Typ. Switching Time vs. R_G
T_J = 150°C; L=200μH; V_{CE}= 600V
I_{CE}= 15A; V_{GE}= 15V

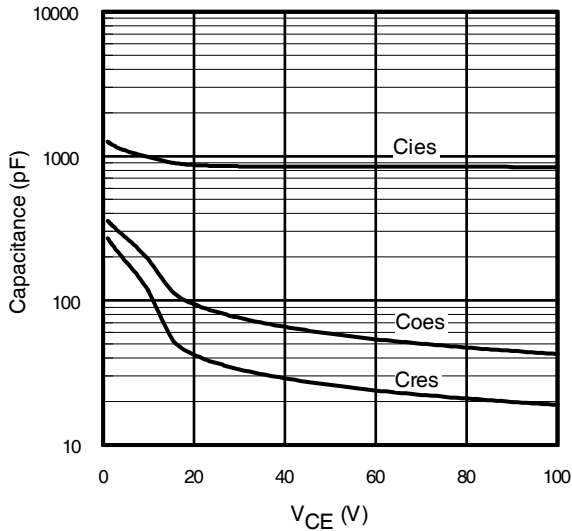

Fig. 16- Typ. Capacitance vs. V_{CE}
V_{GE} = 0V; f = 1MHz

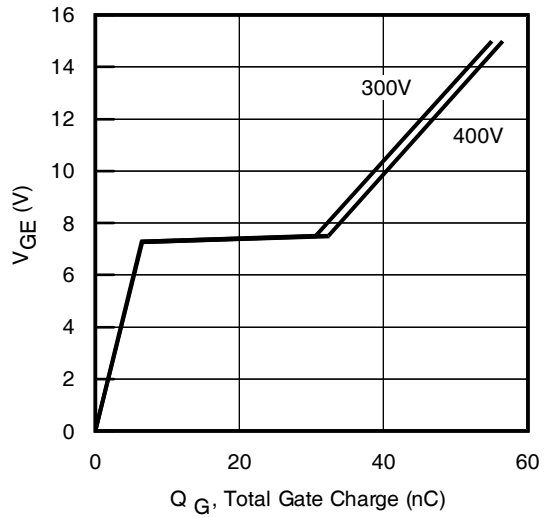

Fig. 17 - Typical Gate Charge vs. V_{GE}
I_{CE} = 15A; L = 600μH

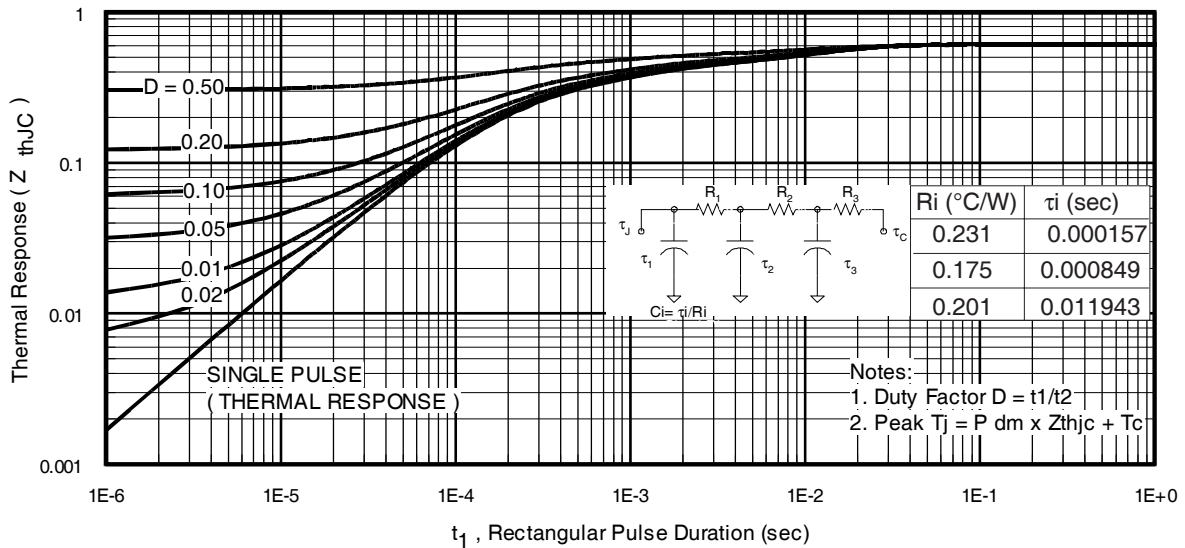

Fig 18. Maximum Transient Thermal Impedance, Junction-to-Case (IGBT)

IRGS15B60KPbF

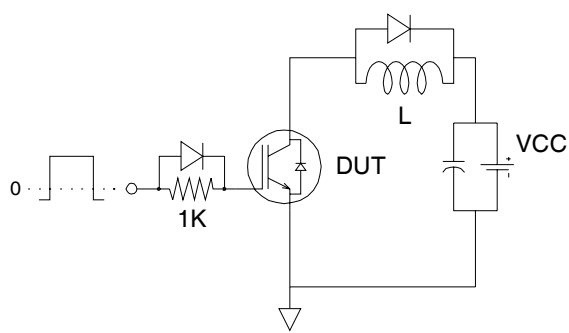

Fig.C.T.1 - Gate Charge Circuit (turn-off)

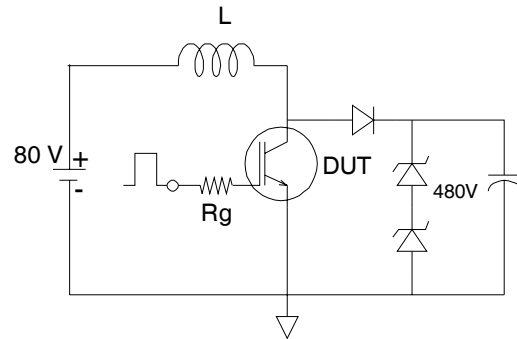

Fig.C.T.2 - RBSOA Circuit

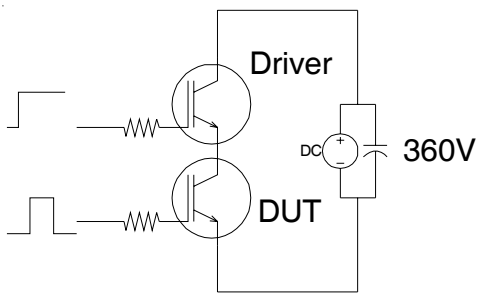

Fig.C.T.3 - S.C.SOA Circuit

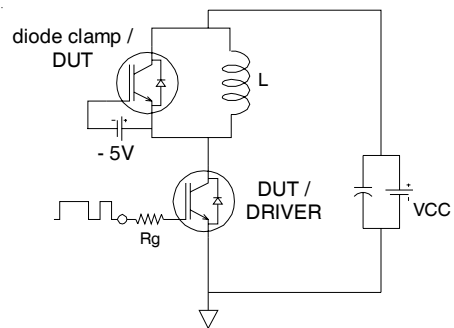

Fig.C.T.4 - Switching Loss Circuit

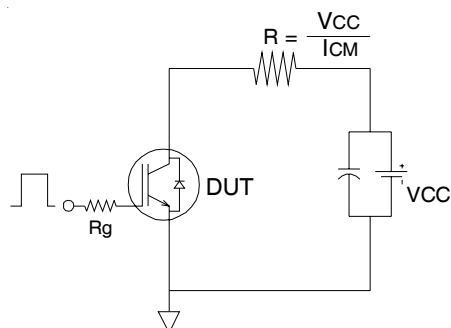
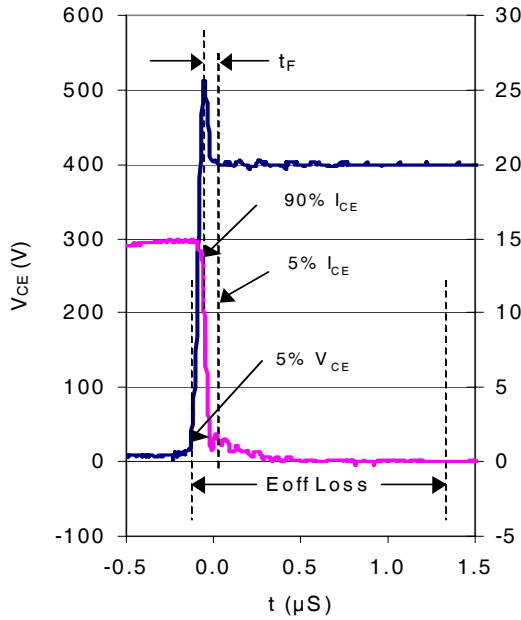
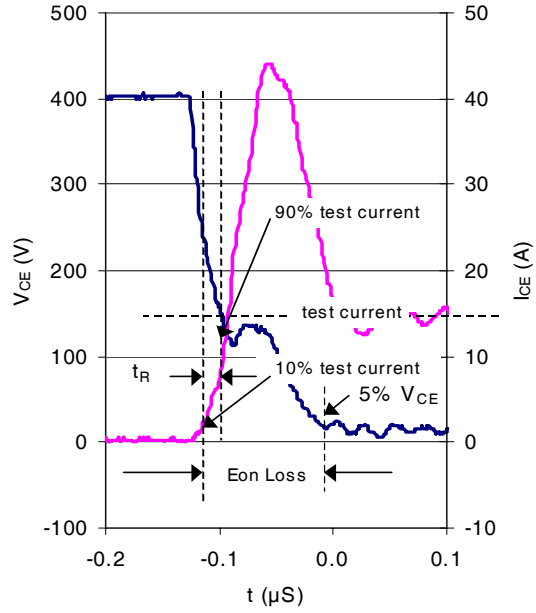

Fig.C.T.5 - Resistive Load Circuit



WF.1- Typ. Turn-off Loss
 @ $T_J = 150^\circ\text{C}$ using CT.4



WF.2- Typ. Turn-on Loss
 @ $T_J = 150^\circ\text{C}$ using Fig. CT.4

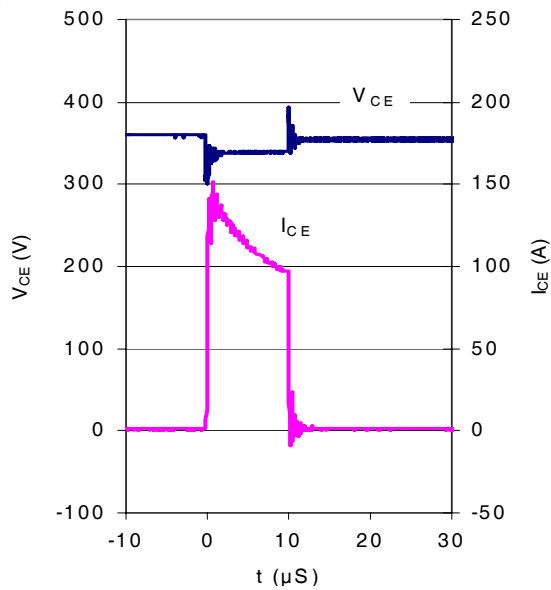

WF.3- Typ. Short Circuit
 @ $T_J = 150^\circ\text{C}$ using CT.3

IRGS15B60KPbF



D²Pak Package Outline

Dimensions are shown in millimeters (inches)

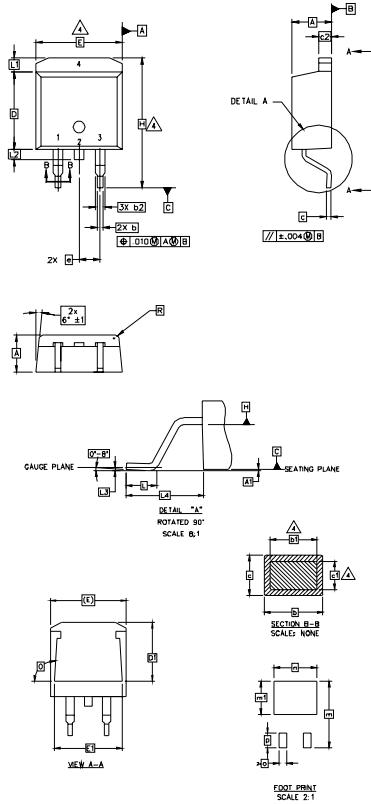

- NOTES:
1. DIMENSIONING AND TOLERANCING PER ASME Y14.5M-1994
 2. DIMENSIONS ARE SHOWN IN MILLIMETERS [INCHES].
 3. DIMENSION D & E DO NOT INCLUDE MOLD FLASH. MOLD FLASH SHALL NOT EXCEED 0.127 [0.005"] PER SIDE. THESE DIMENSIONS ARE MEASURED AT THE OUTMOST EXTREMES OF THE PLASTIC BODY.
 4. DIMENSION b1 AND c1 APPLY TO BASE METAL ONLY.
 5. CONTROLLING DIMENSION: INCH.

SYMBOL	DIMENSIONS				NOTES
	MILLIMETERS		INCHES		
	MIN.	MAX.	MIN.	MAX.	
A	4.06	4.83	.160	.190	4
A1	0.00	0.254	.000	.010	
b	0.51	0.99	.020	.039	
b1	0.51	0.89	.020	.035	
b2	1.14	1.78	.045	.070	4
c	0.38	0.74	.015	.029	
c1	0.38	0.58	.015	.023	3
c2	1.14	1.65	.045	.065	
D	8.51	9.65	.335	.380	3
D1	6.86		.270		
E	9.65	10.67	.380	.420	3
E1	6.22		.245		
e	2.54 BSC		.100 BSC		
H	14.61	15.88	.575	.625	
L	1.78	2.79	.070	.110	
L1		1.65		.065	
L2	1.27	1.78	.050	.070	
L3	0.25 BSC		.010 BSC		
L4	4.78	5.28	.188	.208	
m	17.78		.700		
m1	8.89		.350		
n	11.43		.450		
o	2.08		.082		
p	3.81		.150		
R	0.51	0.71	.020	.028	
θ	90°	93°	90°	93°	

LEAD ASSIGNMENTS

- HEXFET
- 1.- GATE
 - 2, 4.- DRAIN
 - 3.- SOURCE

IGBTs, CoPACK

- 1.- GATE
- 2, 4.- COLLECTOR
- 3.- EMITTER

DIODES

- 1.- ANODE *
- 2, 4.- CATHODE
- 3.- ANODE

* PART DEPENDENT.

D²Pak Part Marking Information

EXAMPLE: THIS IS AN IRF530S WITH
LOT CODE 8024
ASSEMBLED ON WW02, 2000
IN THE ASSEMBLY LINE "L"

Note: "P" in assembly line position
indicates "Lead - Free"

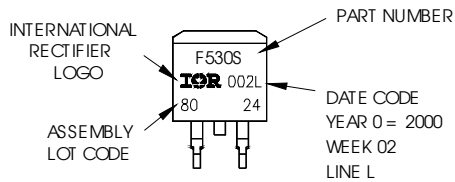

OR

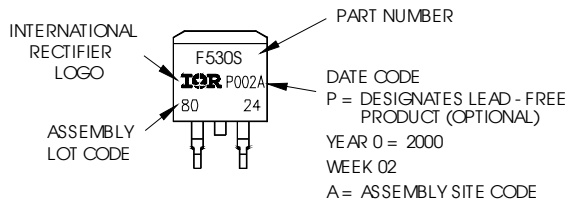

D²Pak Tape & Reel Information

Dimensions are shown in millimeters (inches)

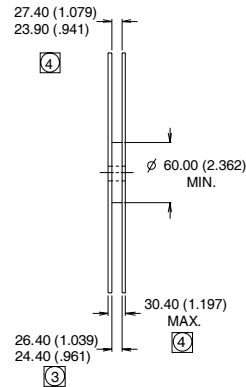
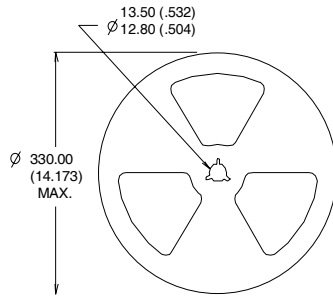
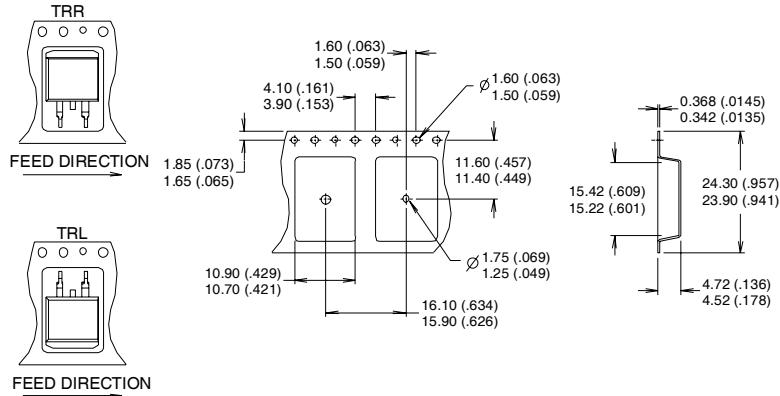

- NOTES:
1. CONFORMS TO EIA-418.
 2. CONTROLLING DIMENSION: MILLIMETER.
 - ③ DIMENSION MEASURED @ HUB.
 - ④ INCLUDES FLANGE DISTORTION @ OUTER EDGE.

Notes:

- ① This is applied to D²Pak, when mounted on 1" square PCB (FR-4 or G-10 Material).
 For recommended footprint and soldering techniques refer to application note #AN-994.
- ② Energy losses include "tail" and diode reverse recovery, using Diode HF15D060ACE.
- ③ $V_{CC} = 80\% (V_{CES})$, $V_{GE} = 20V$, $L = 100\mu H$, $R_G = 22\Omega$.

Data and specifications subject to change without notice.
 This product has been designed and qualified for Industrial market.
 Qualification Standards can be found on IR's Web site.

Mouser Electronics

Authorized Distributor

Click to View Pricing, Inventory, Delivery & Lifecycle Information:

[International Rectifier:](#)

[IRGS15B60KPBF](#)