

# MOSFET

Metal Oxide Semiconductor Field Effect Transistor

## CFDA Automotive

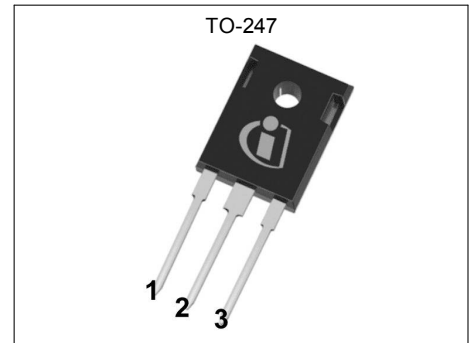
650V CoolMOS™ CFDA Power Transistor  
IPW65R080CFDA

## Data Sheet

Rev. 2.1  
Final

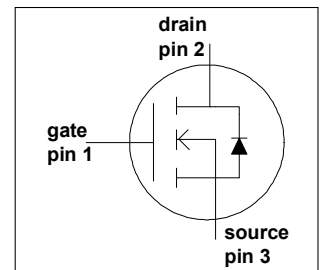
## 1 Description

CoolMOS™ is a revolutionary technology for high voltage power MOSFETs, designed according to the superjunction (SJ) principle and pioneered by Infineon Technologies. 650V CoolMOS™ CFDA series combines the experience of the leading SJ MOSFET supplier with high class innovation. The resulting devices provide all benefits of a fast switching SJ MOSFET while offering an extremely fast and robust body diode. This combination of extremely low switching, commutation and conduction losses together with highest robustness make especially resonant switching applications more reliable, more efficient, lighter, and cooler.



## Features

- Ultra-fast body diode
- Very high commutation ruggedness
- Extremely low losses due to very low FOM  $R_{ds(on)} \cdot Q_g$  and  $E_{oss}$
- Easy to use/drive
- Qualified according to AEC Q101
- Green package (RoHS compliant), Pb-free plating, halogen free for mold compound



## Applications

650V CoolMOS™ CFDA is designed for switching applications.



**Table 1 Key Performance Parameters**

Parameter	Value	Unit
$V_{DS}$	650	V
$R_{DS(on),max}$	0.08	$\Omega$
$Q_g,typ$	161	nC
$I_D,pulse$	137	A
$E_{oss @ 400V}$	12.5	$\mu J$
Body diode $di/dt$	900	A/ $\mu s$
$Q_{rr}$	1.2	$\mu C$
$t_{rr}$	180	ns
$I_{rrm}$	10	A

Type / Ordering Code	Package	Marking	Related Links
IPW65R080CFDA	PG-TO 247	65F6080A	-



**Table of Contents**

Description .....	2
Table of Contents .....	3
Maximum ratings .....	4
Thermal characteristics .....	5
Electrical characteristics .....	6
Electrical characteristics diagrams .....	8
Test Circuits .....	12
Package Outlines .....	13
Revision History .....	14
Disclaimer .....	14

## 2 Maximum ratings

at  $T_j = 25^\circ\text{C}$ , unless otherwise specified

**Table 2 Maximum ratings**

Parameter	Symbol	Values			Unit	Note / Test Condition
		Min.	Typ.	Max.		
Continuous drain current <sup>1)</sup>	$I_D$			43.3	A	$T_C = 25^\circ\text{C}$
				27.4		$T_C = 100^\circ\text{C}$
Pulsed drain current <sup>2)</sup>	$I_{D,pulse}$			137	A	$T_C = 25^\circ\text{C}$
Avalanche energy, single pulse	$E_{AS}$			1160	mJ	$I_D = 8.7\text{A}$ , $V_{DD} = 50\text{V}$ (see table 18)
Avalanche energy, repetitive	$E_{AR}$			1.76	mJ	$I_D = 8.7\text{A}$ , $V_{DD} = 50\text{V}$
Avalanche current, repetitive	$I_{AR}$			8.7	A	
MOSFET dv/dt ruggedness	dv/dt			50	V/ns	$V_{DS} = 0 \dots 400\text{V}$
Gate source voltage	$V_{GS}$	-20		20	V	static
		-30		30		AC ( $f > 1\text{ Hz}$ )
Power dissipation (non FullPAK) TO-247	$P_{Tot}$			391	W	$T_C = 25^\circ\text{C}$
Operating and storage temperature	$T_j, T_{stg}$	-40		150	$^\circ\text{C}$	
Mounting torque (non FullPAK) TO-247				60	Ncm	M3 and M3.5 screws
Continuous diode forward current	$I_S$			43.3	A	$T_C = 25^\circ\text{C}$
Diode pulse current	$I_{S,pulse}$			140	A	$T_C = 25^\circ\text{C}$
Reverse diode dv/dt <sup>3)</sup>	dv/dt			50	V/ns	$V_{DS} = 0 \dots 400\text{V}$ , $I_{SD} \leq I_D$ , $T_j = 25^\circ\text{C}$ (see table 16)
Maximum diode commutation speed	$di_f/dt$			900	A/ $\mu\text{s}$	

<sup>1)</sup> Limited by  $T_{j\text{ max}}$ .

<sup>2)</sup> Pulse width  $t_p$  limited by  $T_{j\text{ max}}$

<sup>3)</sup> Identical low side and high side switch with identical  $R_G$

### 3 Thermal characteristics

**Table 3 Thermal characteristics TO-247**

Parameter	Symbol	Values			Unit	Note / Test Condition
		Min.	Typ.	Max.		
Thermal resistance, junction - case	$R_{thJC}$			0.32	K/W	
Thermal resistance, junction - ambient	$R_{thJA}$			62	K/W	leaded
Soldering temperature, wavesoldering only allowed at leads	$T_{sold}$			260	°C	1.6 mm (0.063 in.) from case for 10s

## 4 Electrical characteristics

at  $T_j = 25^\circ\text{C}$ , unless otherwise specified

**Table 4 Static characteristics**

Parameter	Symbol	Values			Unit	Note / Test Condition
		Min.	Typ.	Max.		
Drain-source breakdown voltage <sup>1)</sup>	$V_{(BR)DSS}$	650			V	$V_{GS} = 0V, I_D = 1mA$
Gate threshold voltage	$V_{GS(th)}$	3.5	4	4.5	V	$V_{DS} = V_{GS}, I_D = 1.76mA$
Zero gate voltage drain current	$I_{DSS}$			2	$\mu A$	$V_{DS} = 650V, V_{GS} = 0V, T_j = 25^\circ C$
			500			$V_{DS} = 650V, V_{GS} = 0V, T_j = 150^\circ C$
Gate-source leakage current	$I_{GSS}$			100	nA	$V_{GS} = 20V, V_{DS} = 0V$
Drain-source on-state resistance	$R_{DS(on)}$		0.072	0.08	$\Omega$	$V_{GS} = 10V, I_D = 17.6A, T_j = 25^\circ C$
			0.19			$V_{GS} = 10V, I_D = 17.6A, T_j = 150^\circ C$
Gate resistance	$R_G$		0.75		$\Omega$	$f = 1MHz, \text{open drain}$

**Table 5 Dynamic characteristics**

Parameter	Symbol	Values			Unit	Note / Test Condition
		Min.	Typ.	Max.		
Input capacitance	$C_{iss}$		4440		pF	$V_{GS} = 0V, V_{DS} = 100V, f = 1MHz$
Output capacitance	$C_{oss}$		210		pF	
Effective output capacitance, energy related <sup>2)</sup>	$C_{o(er)}$		160		pF	$V_{GS} = 0V, V_{DS} = 0 \dots 400V$
Effective output capacitance, time related <sup>3)</sup>	$C_{o(tr)}$		754		pF	$I_D = \text{constant}, V_{GS} = 0V, V_{DS} = 0 \dots 400V$
Turn-on delay time	$t_{d(on)}$		20		ns	$V_{DD} = 480V, V_{GS} = 13V, I_D = 26.3A, R_G = 1.8\Omega$ (see table 17)
Rise time	$t_r$		18		ns	
Turn-off delay time	$t_{d(off)}$		85		ns	
Fall time	$t_f$		6		ns	

**Table 6 Gate charge characteristics**

Parameter	Symbol	Values			Unit	Note / Test Condition
		Min.	Typ.	Max.		
Gate to source charge	$Q_{gs}$		28		nC	$V_{DD} = 480V, I_D = 26.3A, V_{GS} = 0 \text{ to } 10V$
Gate to drain charge	$Q_{gd}$		87		nC	
Gate charge total	$Q_g$		161		nC	
Gate plateau voltage	$V_{plateau}$		6.4		V	

<sup>1)</sup> For applications with applied blocking voltage > 65% of the specified blocking voltage, we recommend to evaluate the impact of the cosmic radiation effect in early design phase. For assessment please contact local Infineon sales office.

<sup>2)</sup>  $C_{o(er)}$  is a fixed capacitance that gives the same stored energy as  $C_{oss}$  while  $V_{DS}$  is rising from 0 to 400V

<sup>3)</sup>  $C_{o(tr)}$  is a fixed capacitance that gives the same charging time as  $C_{oss}$  while  $V_{DS}$  is rising from 0 to 400V

**Table 7 Reverse diode characteristics**

Parameter	Symbol	Values			Unit	Note / Test Condition
		Min.	Typ.	Max.		
Diode forward voltage	$V_{SD}$		0.9		V	$V_{GS} = 0V, I_F = 26.3A, T_j = 25^\circ C$
Reverse recovery time	$t_{rr}$		180		ns	$V_R = 400V, I_F = 26.3A,$ $di_F/dt = 100A/\mu s$ (see table 16)
Reverse recovery charge	$Q_{rr}$		1.2		$\mu C$	
Peak reverse recovery current	$I_{rrm}$		10		A	

### 5 Electrical characteristics diagrams

Table 8

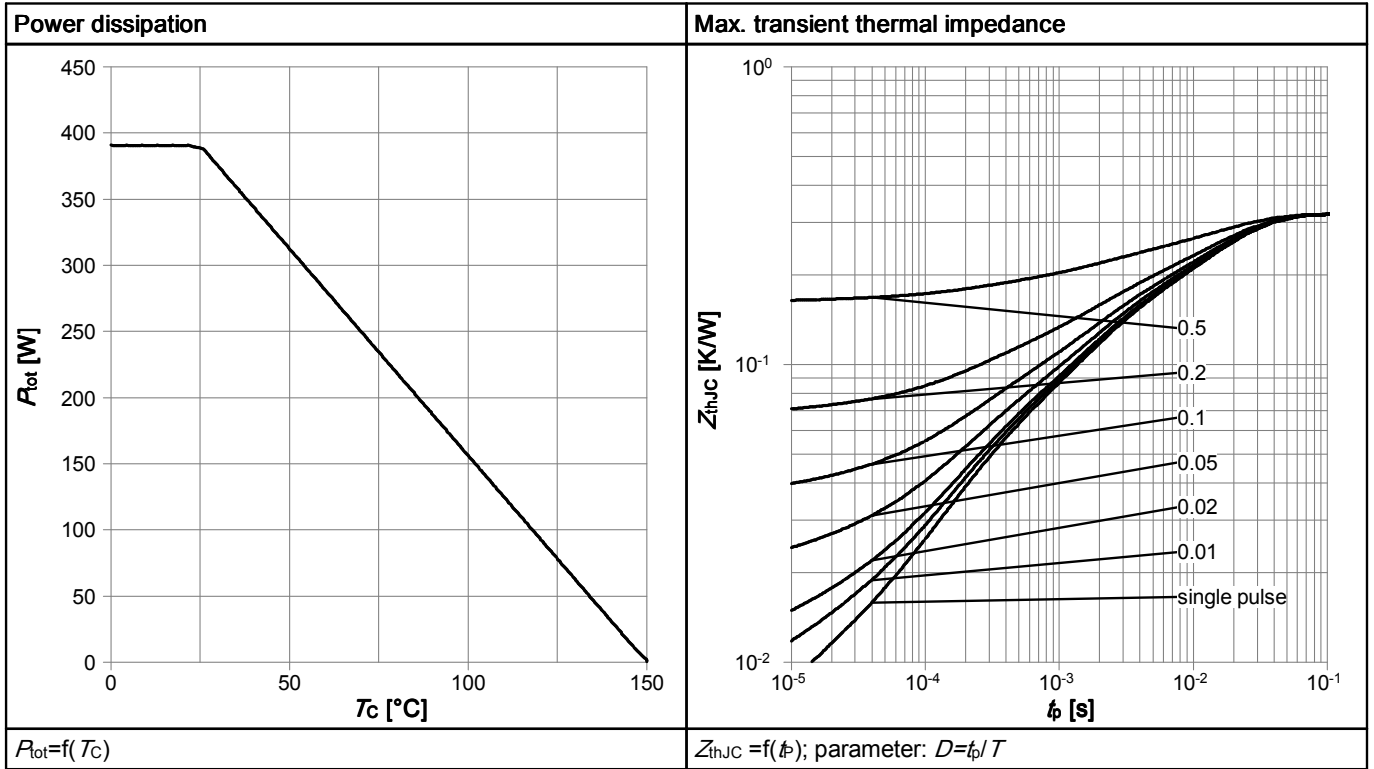


Table 9

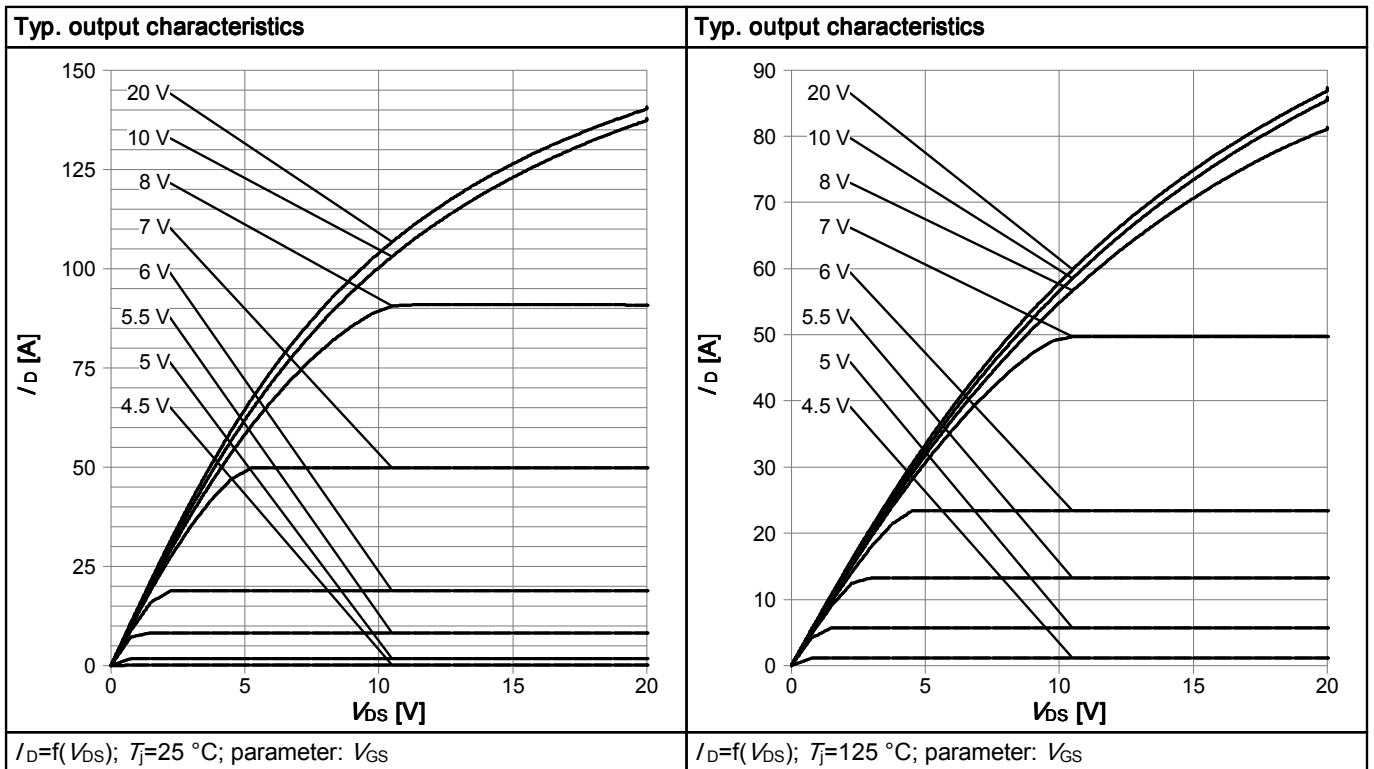




Table 10

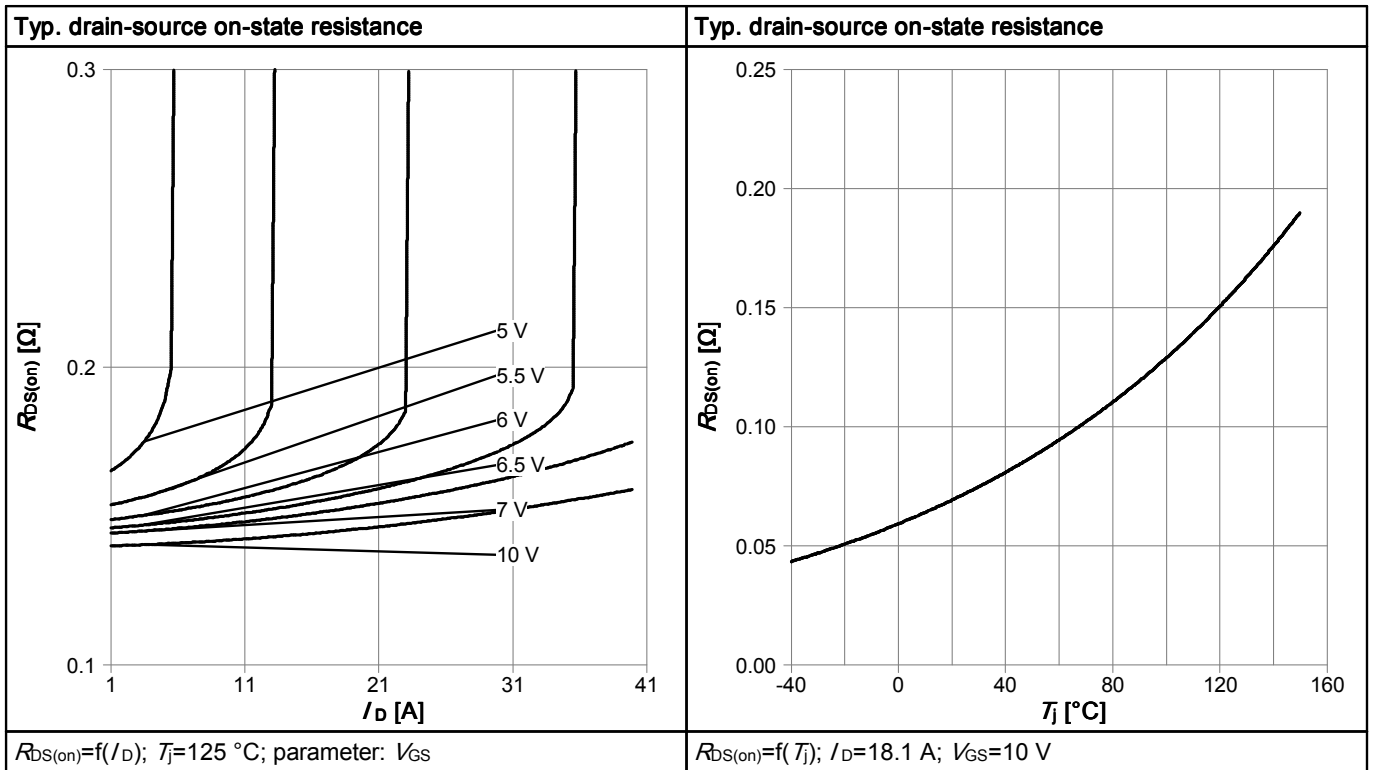


Table 11

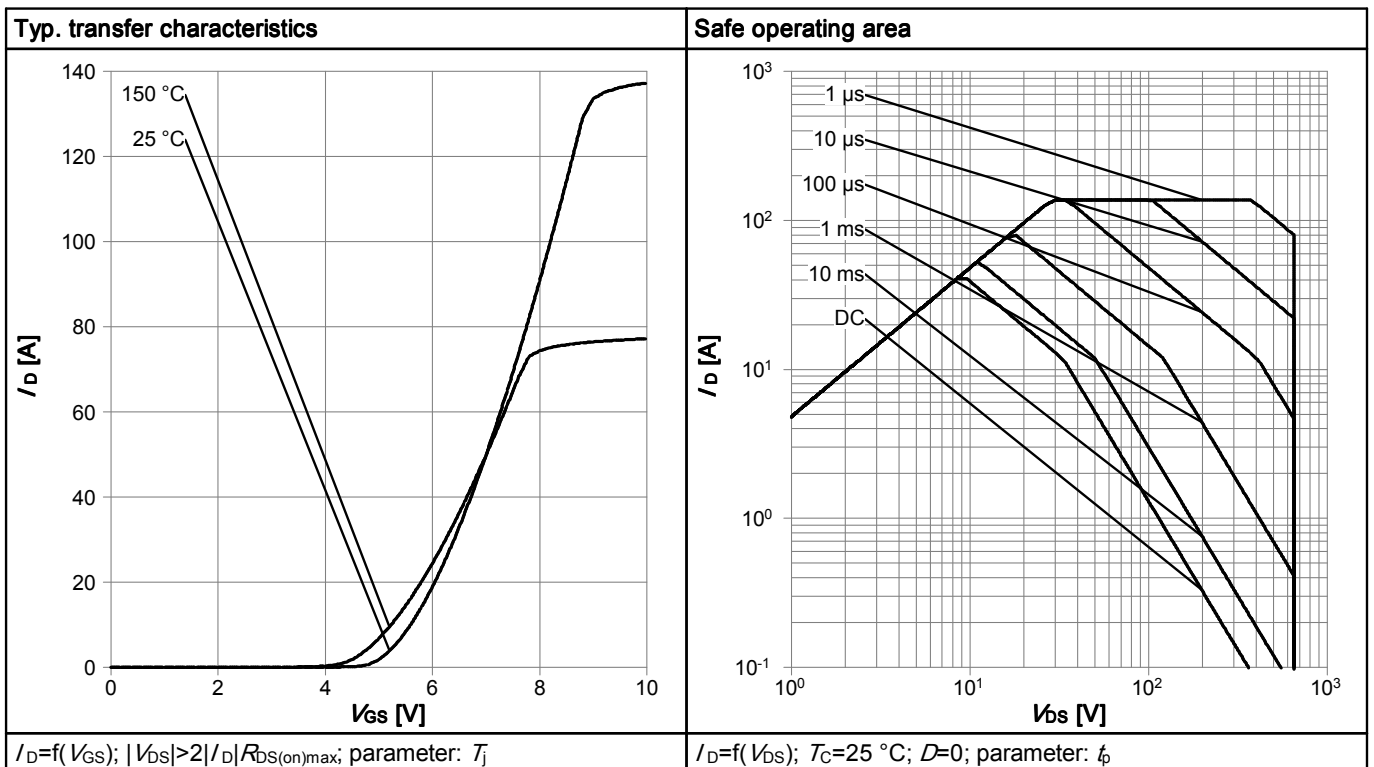


Table 12

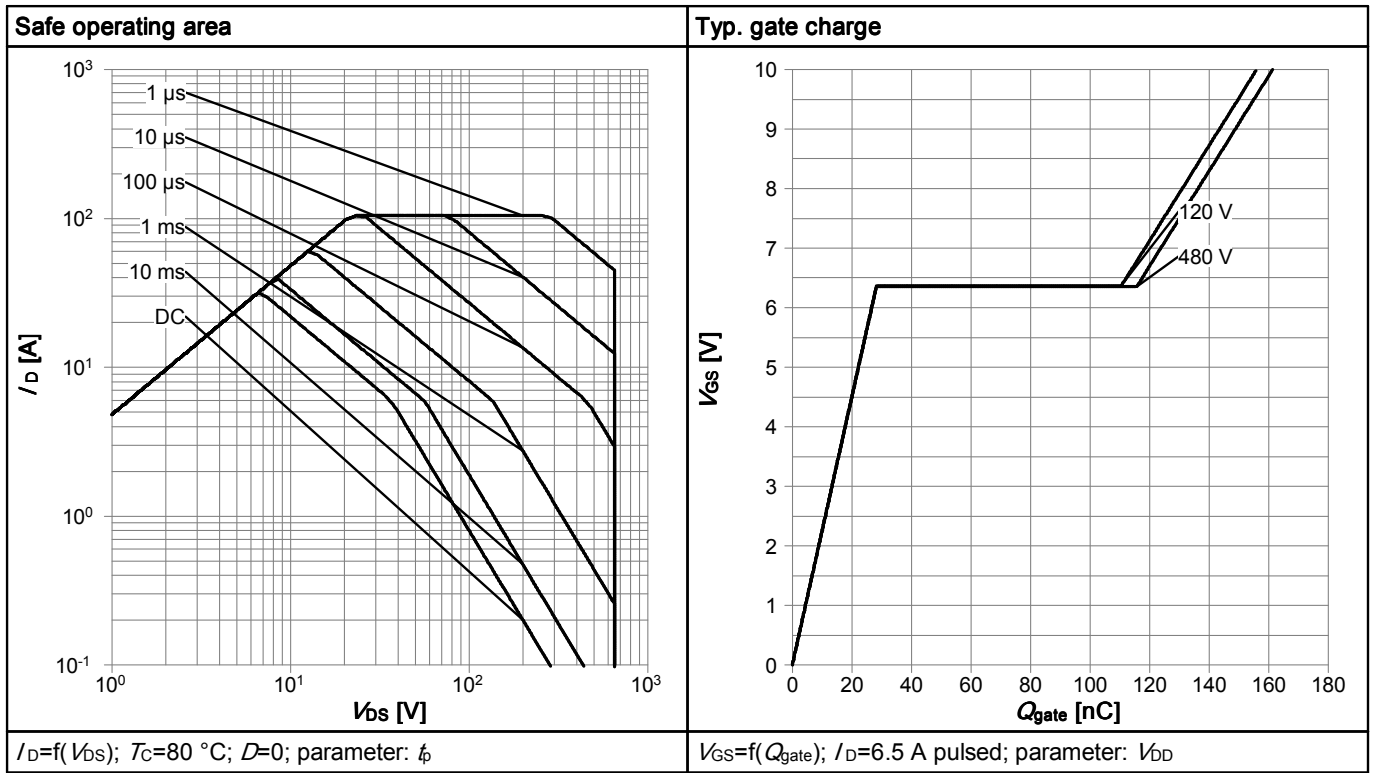
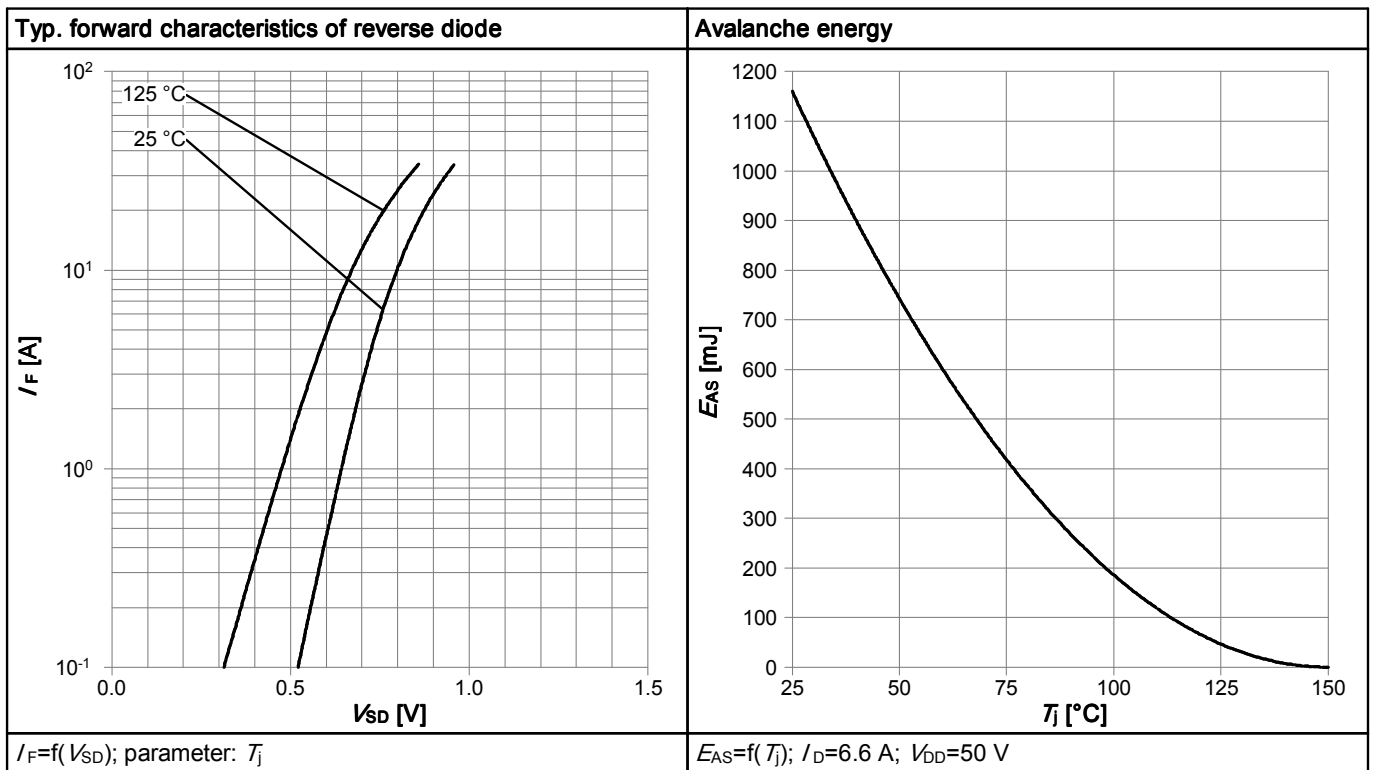
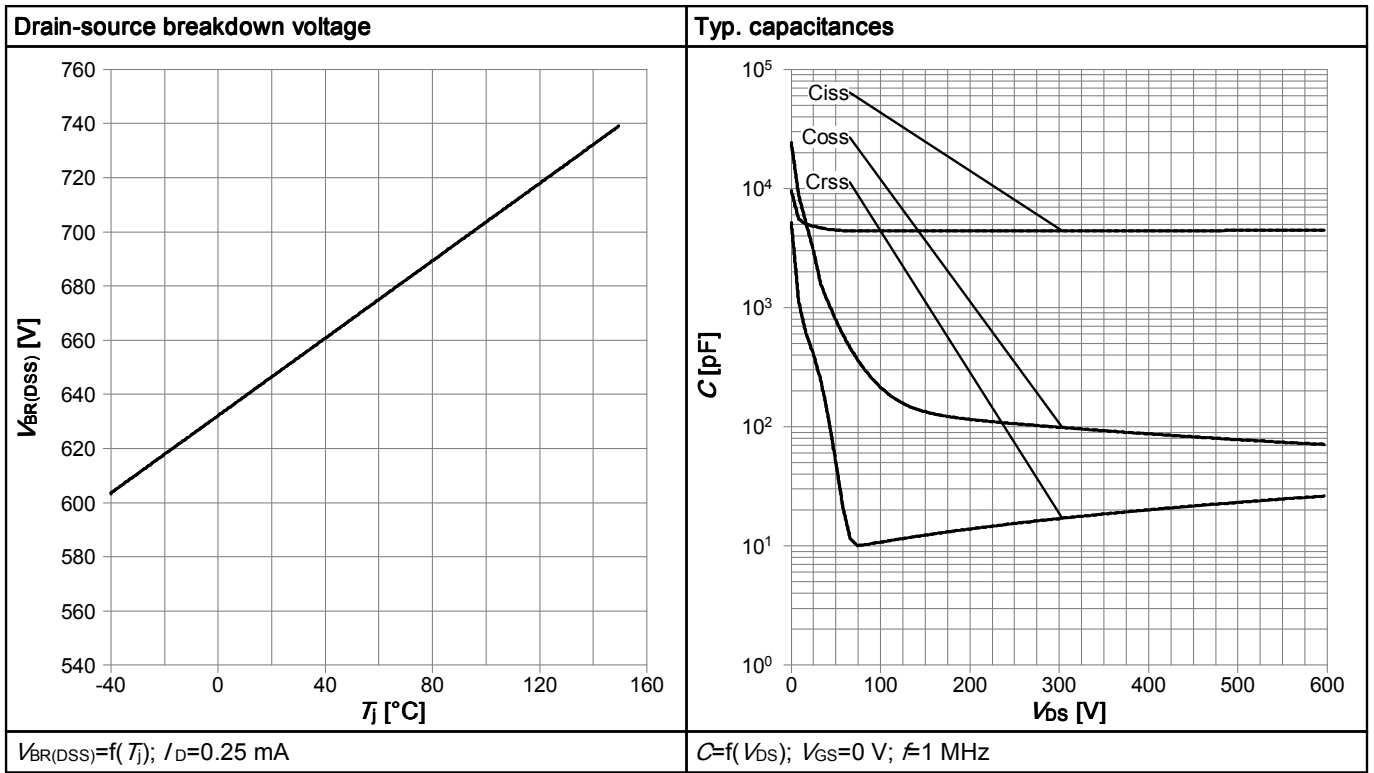


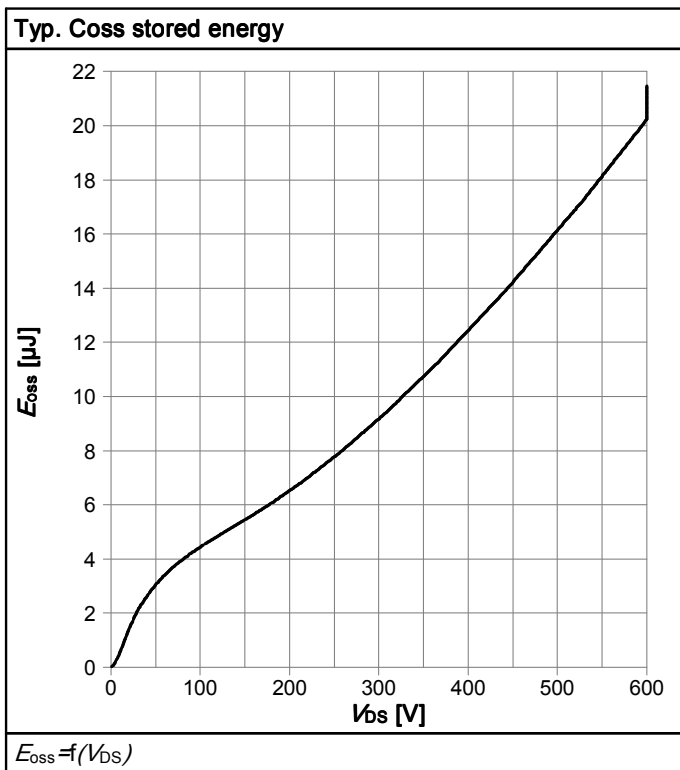
Table 13



**Table 14**

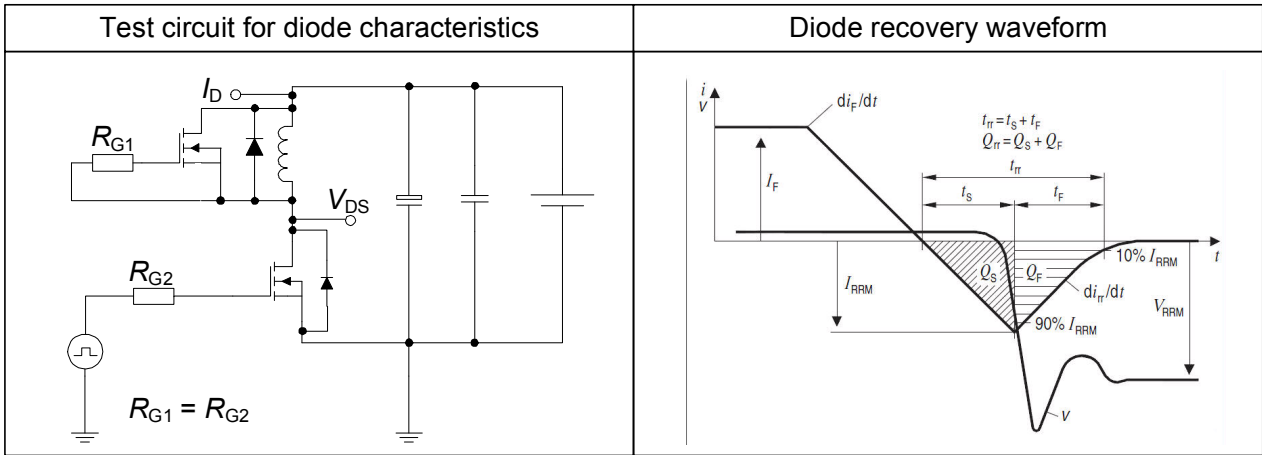


**Table 15**

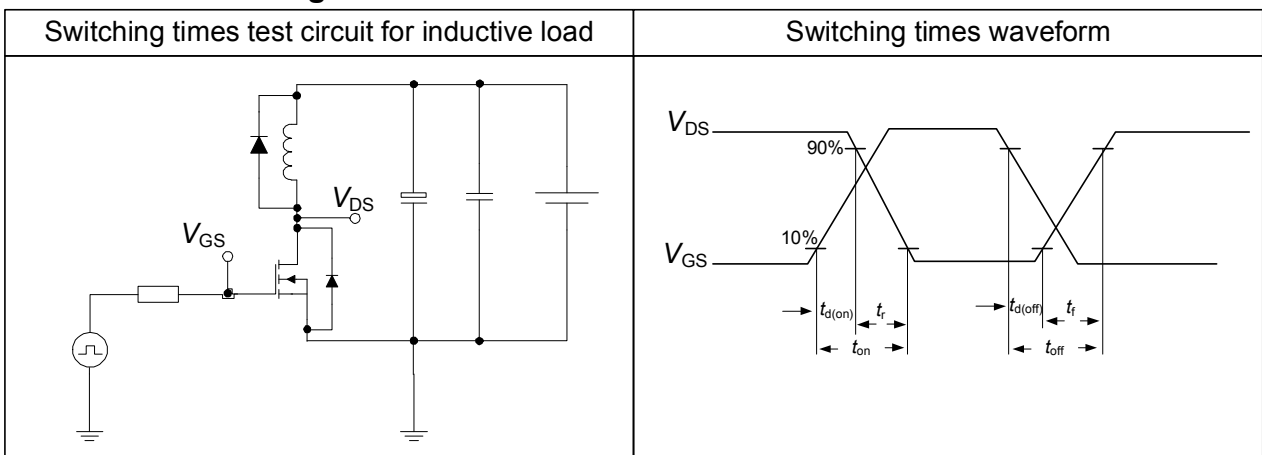


## 6 Test Circuits

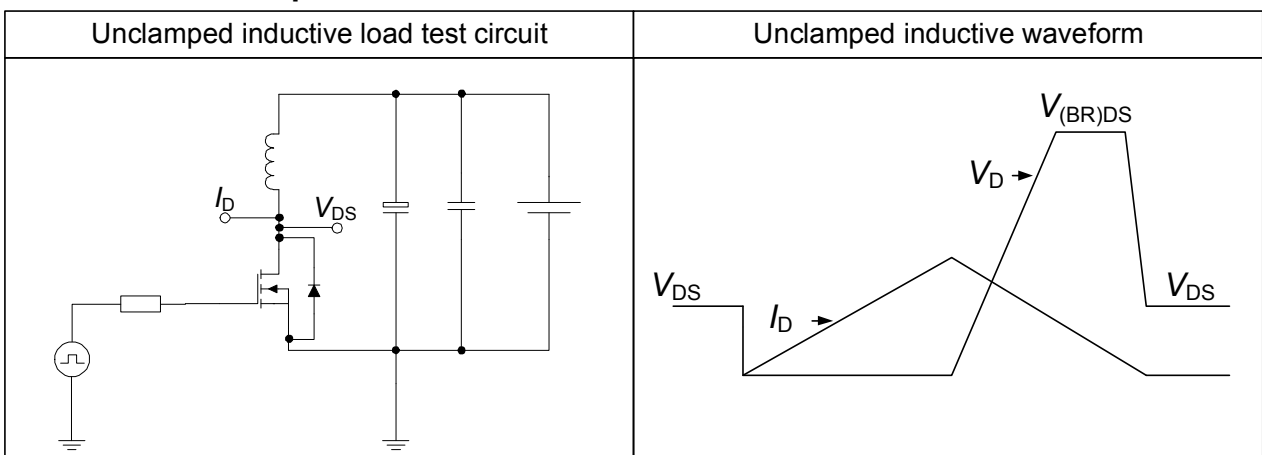
**Table 16 Diode characteristics**



**Table 17 Switching times**



**Table 18 Unclamped inductive**



### 7 Package Outlines

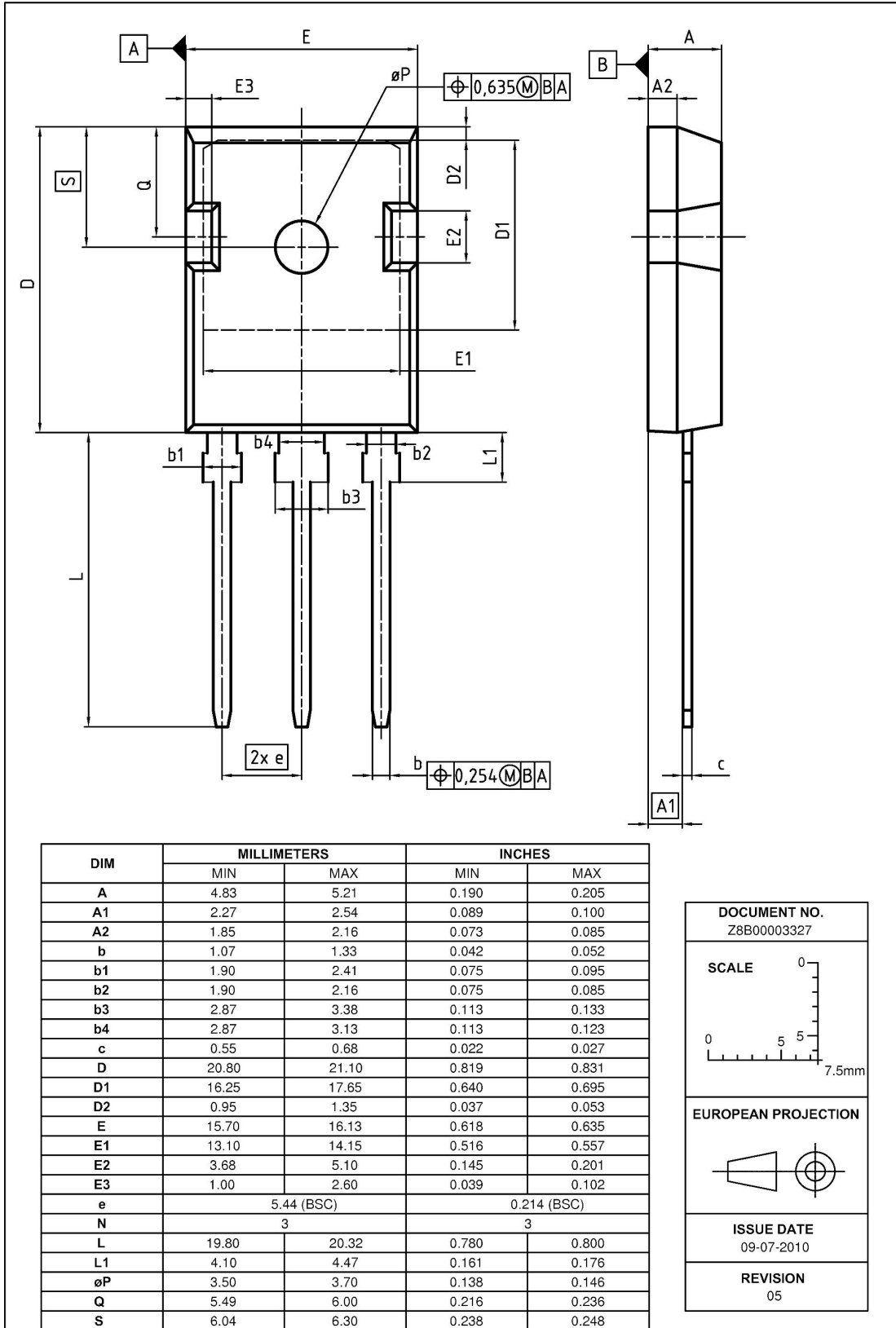


Figure 1 Outline PG-TO 247, dimensions in mm/inches

## Revision History

IPW65R080CFDA

Revision: 2012-04-02, Rev. 2.1

Previous Revision

Revision	Date	Subjects (major changes since last revision)
2.0	2012-03-28	Final datasheet
2.1	2012-04-02	-

### Disclaimer ATV

#### We Listen to Your Comments

Any information within this document that you feel is wrong, unclear or missing at all? Your feedback will help us to continuously improve the quality of this document. Please send your proposal (including a reference to this document) to: [erratum@infineon.com](mailto:erratum@infineon.com)

Edition 2011-09-30

Published by

Infineon Technologies AG

81726 München, Germany

© 2011 Infineon Technologies AG

All Rights Reserved.

### Legal Disclaimer

The information given in this document shall in no event be regarded as a guarantee of conditions or characteristics ("Beschaffenheitsgarantie"). With respect to any examples or hints given herein, any typical values stated herein and/or any information regarding the application of the device, Infineon Technologies hereby disclaims any and all warranties and liabilities of any kind, including without limitation warranties of non-infringement of intellectual property rights of any third party.

### Information

For further information on technology, delivery terms and conditions and prices please contact your nearest Infineon Technologies Office ([www.infineon.com](http://www.infineon.com)).

### Warnings

Due to technical requirements components may contain dangerous substances. For information on the types in question please contact your nearest Infineon Technologies Office.

Infineon Technologies Components may only be used in life-support devices or systems with the express written approval of Infineon Technologies, if a failure of such components can reasonably be expected to cause the failure of that life-support device or system, or to affect the safety or effectiveness of that device or system. Life support devices or systems are intended to be implanted in the human body, or to support and/or maintain and sustain and/or protect human life. If they fail, it is reasonable to assume that the health of the user or other persons may be endangered.

# Mouser Electronics

Authorized Distributor

Click to View Pricing, Inventory, Delivery & Lifecycle Information:

[Infineon:](#)

[IPW65R080CFDAFKSA1](#)