

## MOSFET

Metal Oxide Semiconductor Field Effect Transistor

### CoolMOS™ CFD2 650V

650V CoolMOS™ CFD2 Power Transistor  
IPx65R660CFD

## Data Sheet

Rev. 2.5  
Final

Industrial & Multimarket

## 1 Description

CoolMOS™ is a revolutionary technology for high voltage power MOSFETs, designed according to the superjunction (SJ) principle and pioneered by Infineon Technologies. 650V CoolMOS™ CFD2 series combines the experience of the leading SJ MOSFET supplier with high class innovation. The resulting devices provide all benefits of a fast switching SJ MOSFET while offering an extremely fast and robust body diode. This combination of extremely low switching, commutation and conduction losses together with highest robustness make especially resonant switching applications more reliable, more efficient, lighter, and cooler.

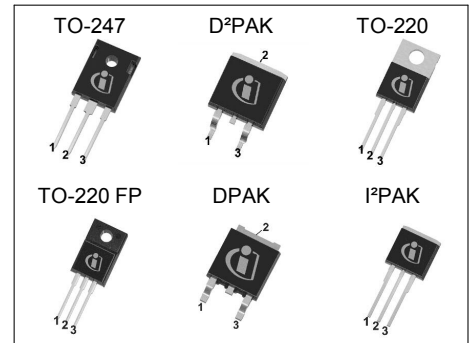

## Features

- Ultra-fast body diode
- Very high commutation ruggedness
- Extremely low losses due to very low FOM  $R_{ds(on)} \cdot Q_g$  and  $E_{oss}$
- Easy to use/drive
- Qualified for industrial grade applications according to JEDEC (J-STD20 and JESD22)
- Pb-free plating, Halogen free mold compound

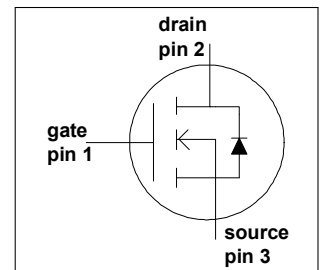

## Applications

650V CoolMOS™ CFD2 is especially suitable for resonant switching PWM stages for e.g. PC Silverbox, LCD TV, Lighting, Server, Telecom, and Solar.



**Table 1 Key Performance Parameters**

Parameter	Value	Unit
$V_{DS} @ T_{j \max}$	700	V
$R_{DS(on),max}$	0.66	$\Omega$
$Q_g,typ$	22	nC
$I_D,pulse$	17	A
$E_{oss} @ 400V$	1.8	$\mu J$
Body diode $di/dt$	900	A/ $\mu s$
$Q_{rr}$	0.2	$\mu C$
$t_{rr}$	65	ns
$I_{rrm}$	4.5	A

Type / Ordering Code	Package	Marking	Related Links
IPW65R660CFD	PG-TO 247	65F6660	see Appendix A
IPB65R660CFD	PG-TO 263		
IPP65R660CFD	PG-TO 220		
IPA65R660CFD	PG-TO 220 FullPAK		
IPD65R660CFD	PG-TO 252		
IPI65R660CFD	PG-TO 262		



## Table of Contents

Description .....	2
Table of Contents .....	3
Maximum ratings .....	4
Thermal characteristics .....	5
Electrical characteristics .....	6
Electrical characteristics diagrams .....	8
Test Circuits .....	13
Package Outlines .....	14
Appendix A .....	20
Revision History .....	21
Disclaimer .....	21

## 2 Maximum ratings

at  $T_j = 25^\circ\text{C}$ , unless otherwise specified

**Table 2 Maximum ratings**

Parameter	Symbol	Values			Unit	Note / Test Condition
		Min.	Typ.	Max.		
Continuous drain current <sup>1)</sup>	$I_D$			6.0	A	$T_C = 25^\circ\text{C}$
				3.8		$T_C = 100^\circ\text{C}$
Pulsed drain current <sup>2)</sup>	$I_{D,pulse}$			17	A	$T_C = 25^\circ\text{C}$
Avalanche energy, single pulse	$E_{AS}$			115	mJ	$I_b = 1.2\text{A}$ , $V_{DD} = 50\text{V}$
Avalanche energy, repetitive	$E_{AR}$			0.21	mJ	$I_b = 1.2\text{A}$ , $V_{DD} = 50\text{V}$
Avalanche current, repetitive	$I_{AR}$			1.2	A	
MOSFET dv/dt ruggedness	dv/dt			50	V/ns	$V_{DS} = 0 \dots 400\text{V}$
Gate source voltage	$V_{GS}$	-20		20	V	static
		-30		30		AC ( $f > 1\text{Hz}$ )
Power dissipation (non FullPAK) TO-247, TO-220, I <sup>2</sup> PAK	$P_{tot}$			62.5	W	$T_C = 25^\circ\text{C}$
Power dissipation (FullPAK) TO-220 FP	$P_{tot}$			27.8	W	$T_C = 25^\circ\text{C}$
Operating and storage temperature	$T_j, T_{stg}$	-55		150	$^\circ\text{C}$	
Mounting torque (non FullPAK) TO-247, TO-220, I <sup>2</sup> PAK				60	Ncm	M3 and M3.5 screws
Mounting torque (FullPAK) TO-220 FP				50	Ncm	M2.5 screws
Continuous diode forward current	$I_S$			6.0	A	$T_C = 25^\circ\text{C}$
Diode pulse current	$I_{S,pulse}$			17	A	$T_C = 25^\circ\text{C}$
Reverse diode dv/dt <sup>3)</sup>	dv/dt			50	V/ns	$V_{DS} = 0 \dots 400\text{V}$ , $t_{SD} \leq t_b$ , $T_j = 25^\circ\text{C}$
Maximum diode commutation speed	$di_f/dt$			900	A/ $\mu\text{s}$	

<sup>1)</sup> Limited by  $T_{j,max}$ .

<sup>2)</sup> Pulse width  $t_p$  limited by  $T_{j,max}$

<sup>3)</sup>  $V_{peak} < V_{(BR)DSS}$ ,  $T_j < T_{j,max}$ , identical low side and high side switch with same  $R_g$

### 3 Thermal characteristics

**Table 3 Thermal characteristics TO-247, TO-220, I<sup>2</sup>PAK**

Parameter	Symbol	Values			Unit	Note / Test Condition
		Min.	Typ.	Max.		
Thermal resistance, junction - case	$R_{thJC}$			2	°C/W	
Thermal resistance, junction - ambient	$R_{thJA}$			62	°C/W	leaded
Soldering temperature, wavesoldering only allowed at leads	$T_{sold}$			260	°C	1.6 mm (0.063 in.) from case for 10s

**Table 4 Thermal characteristics TO-220 FP**

Parameter	Symbol	Values			Unit	Note / Test Condition
		Min.	Typ.	Max.		
Thermal resistance, junction - case	$R_{thJC}$			4.5	°C/W	
Thermal resistance, junction - ambient	$R_{thJA}$			80	°C/W	leaded
Soldering temperature, wavesoldering only allowed at leads	$T_{sold}$			260	°C	1.6 mm (0.063 in.) from case for 10s

**Table 5 Thermal characteristics D<sup>2</sup>PAK, DPAK**

Parameter	Symbol	Values			Unit	Note / Test Condition
		Min.	Typ.	Max.		
Thermal resistance, junction - case	$R_{thJC}$			2	°C/W	
Thermal resistance, junction - ambient <sup>1)</sup>	$R_{thJA}$			62	°C/W	SMD version, device on PCB, minimal footprint
			35			SMD version, device on PCB, 6cm <sup>2</sup> cooling area
Soldering temperature, wave- & reflowsoldering allowed	$T_{sold}$			260	°C	reflow MSL

<sup>1)</sup> Device on 40mm\*40mm\*1.5mm one layer epoxy PCB FR4 with 6cm<sup>2</sup> copper area (thickness 70µm) for drain connection. PCB is vertical without air stream cooling.

## 4 Electrical characteristics

at  $T_j = 25^\circ\text{C}$ , unless otherwise specified

**Table 6 Static characteristics**

Parameter	Symbol	Values			Unit	Note / Test Condition
		Min.	Typ.	Max.		
Drain-source breakdown voltage	$V_{(BR)DSS}$	650			V	$V_{GS} = 0V, I_D = 1mA$
Gate threshold voltage	$V_{GS(th)}$	3.5	4	4.5	V	$V_{DS} = V_{GS}, I_D = 0.2mA$
Zero gate voltage drain current	$I_{DSS}$			1	$\mu A$	$V_{DS} = 650V, V_{GS} = 0V, T_j = 25^\circ C$
			100			$V_{DS} = 650V, V_{GS} = 0V, T_j = 150^\circ C$
Gate-source leakage current	$I_{GSS}$			100	nA	$V_{GS} = 20V, V_{DS} = 0V$
Drain-source on-state resistance	$R_{DS(on)}$		0.594	0.66	$\Omega$	$V_{GS} = 10V, I_D = 2.1A, T_j = 25^\circ C$
			1.544			$V_{GS} = 10V, I_D = 2.1A, T_j = 150^\circ C$
Gate resistance	$R_G$		6.5		$\Omega$	$f = 1MHz, \text{open drain}$

**Table 7 Dynamic characteristics**

Parameter	Symbol	Values			Unit	Note / Test Condition
		Min.	Typ.	Max.		
Input capacitance	$C_{iss}$		615		pF	$V_{GS} = 0V, V_{DS} = 100V, f = 1MHz$
Output capacitance	$C_{oss}$		33		pF	
Effective output capacitance, energy related <sup>1)</sup>	$C_{o(er)}$		21		pF	$V_{GS} = 0V, V_{DS} = 0 \dots 400V$
Effective output capacitance, time related <sup>2)</sup>	$C_{o(tr)}$		88		pF	$I_D = \text{constant}, V_{GS} = 0V, V_{DS} = 0 \dots 400V$
Turn-on delay time	$t_{d(on)}$		9		ns	$V_{DD} = 400V, V_{GS} = 13V, I_D = 3.2A, R_G = 6.8\Omega$
Rise time	$t_r$		8		ns	
Turn-off delay time	$t_{d(off)}$		40		ns	
Fall time	$t_f$		10		ns	

**Table 8 Gate charge characteristics**

Parameter	Symbol	Values			Unit	Note / Test Condition
		Min.	Typ.	Max.		
Gate to source charge	$Q_{gs}$		3.5		nC	$V_{DD} = 480V, I_D = 3.2A, V_{GS} = 0 \text{ to } 10V$
Gate to drain charge	$Q_{gd}$		12		nC	
Gate charge total	$Q_g$		22		nC	
Gate plateau voltage	$V_{plateau}$		6.4		V	

<sup>1)</sup>  $C_{o(er)}$  is a fixed capacitance that gives the same stored energy as  $C_{oss}$  while  $V_{DS}$  is rising from 0 to 400V

<sup>2)</sup>  $C_{o(tr)}$  is a fixed capacitance that gives the same charging time as  $C_{oss}$  while  $V_{DS}$  is rising from 0 to 400V

**Table 9 Reverse diode characteristics**

Parameter	Symbol	Values			Unit	Note / Test Condition
		Min.	Typ.	Max.		
Diode forward voltage	$V_{SD}$		0.9		V	$V_{GS} = 0V, I_F = 3.2A, T_j = 25^\circ C$
Reverse recovery time	$t_{rr}$		65		ns	$V_R = 400V, I_F = 3.2A, dI/dt = 100A/\mu s$
Reverse recovery charge	$Q_{rr}$		0.2		$\mu C$	
Peak reverse recovery current	$I_{rrm}$		4.5		A	

## 5 Electrical characteristics diagrams

Table 10

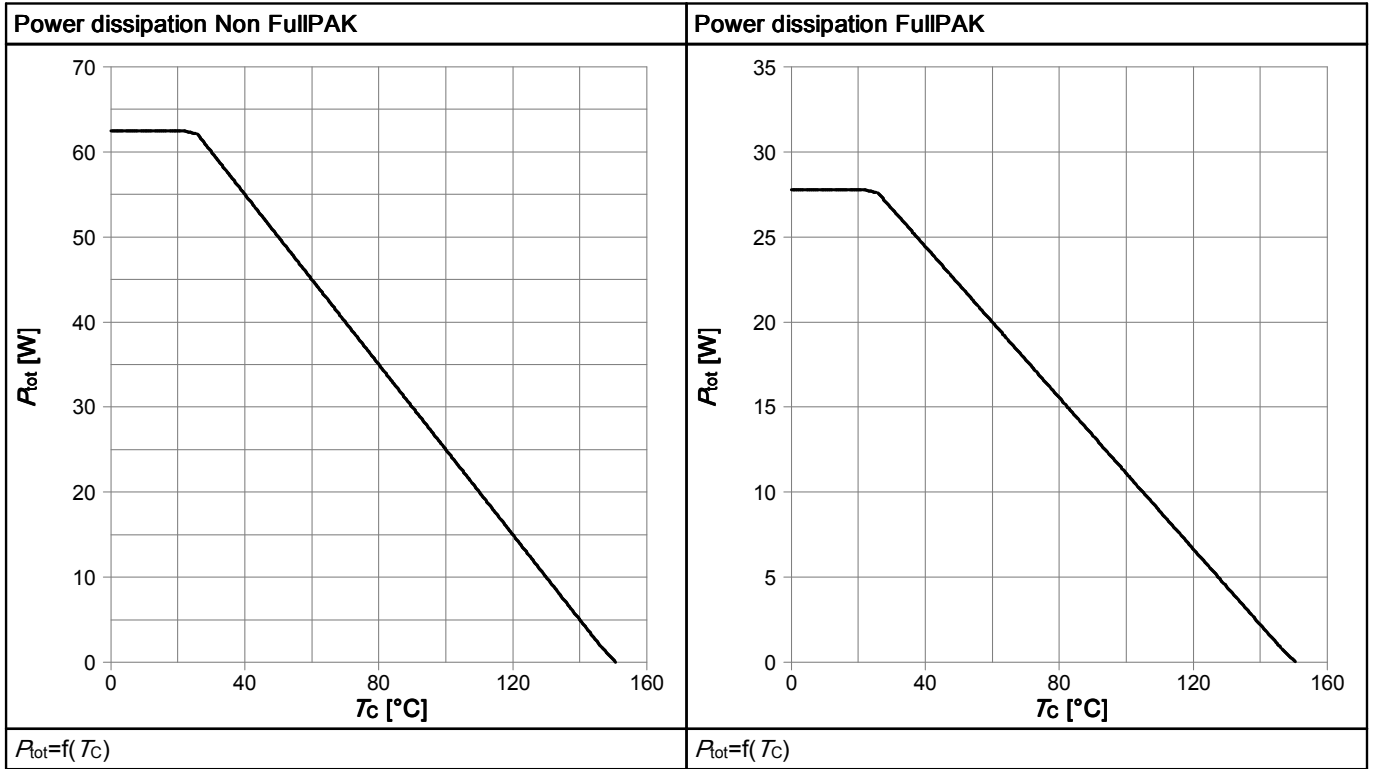

Table 11

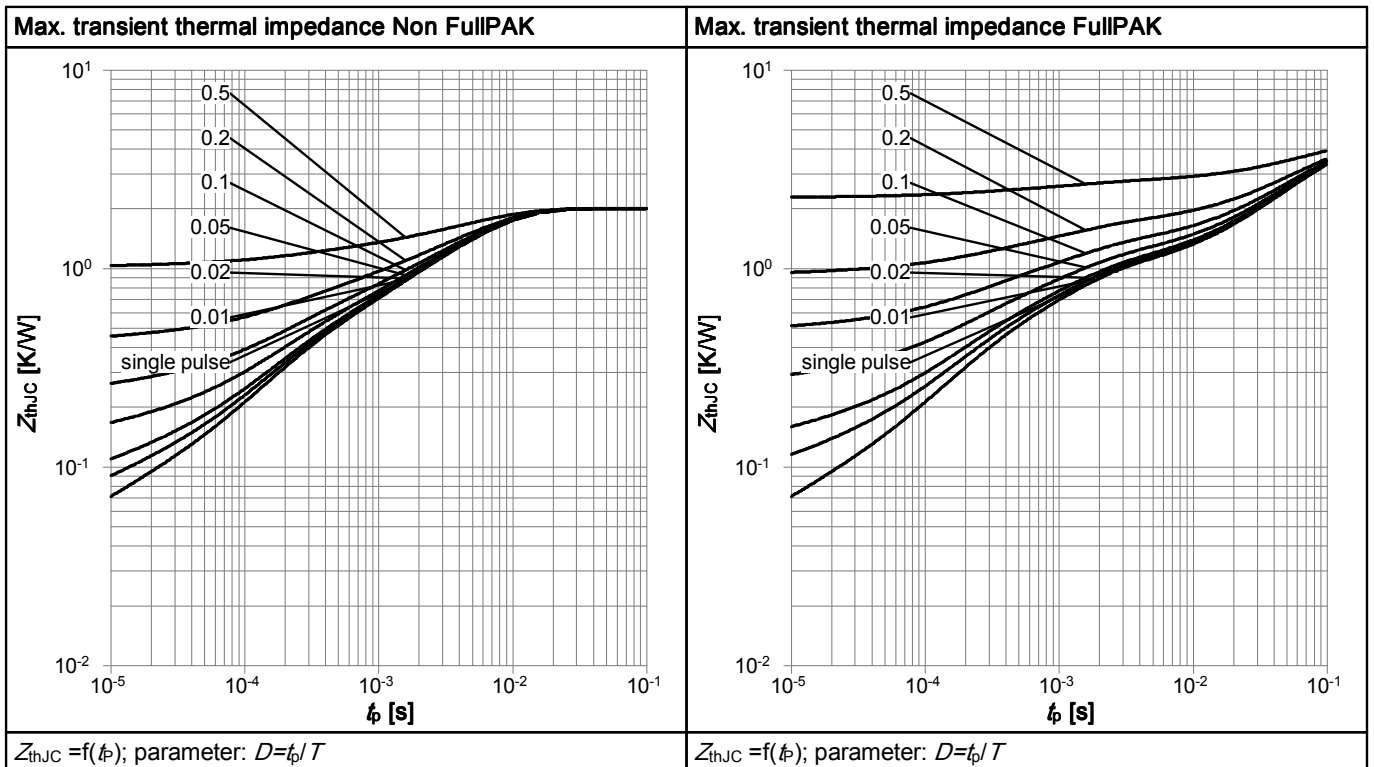



Table 12

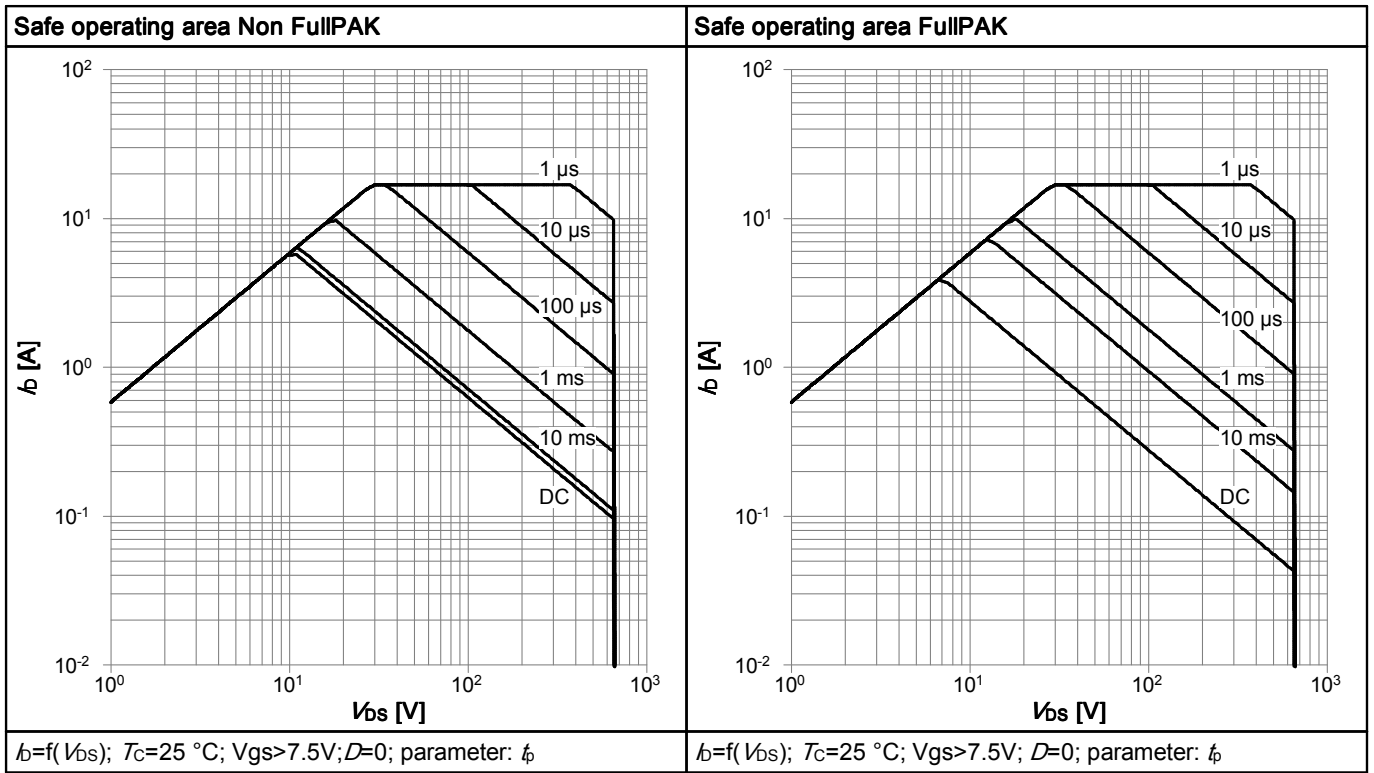

Table 13

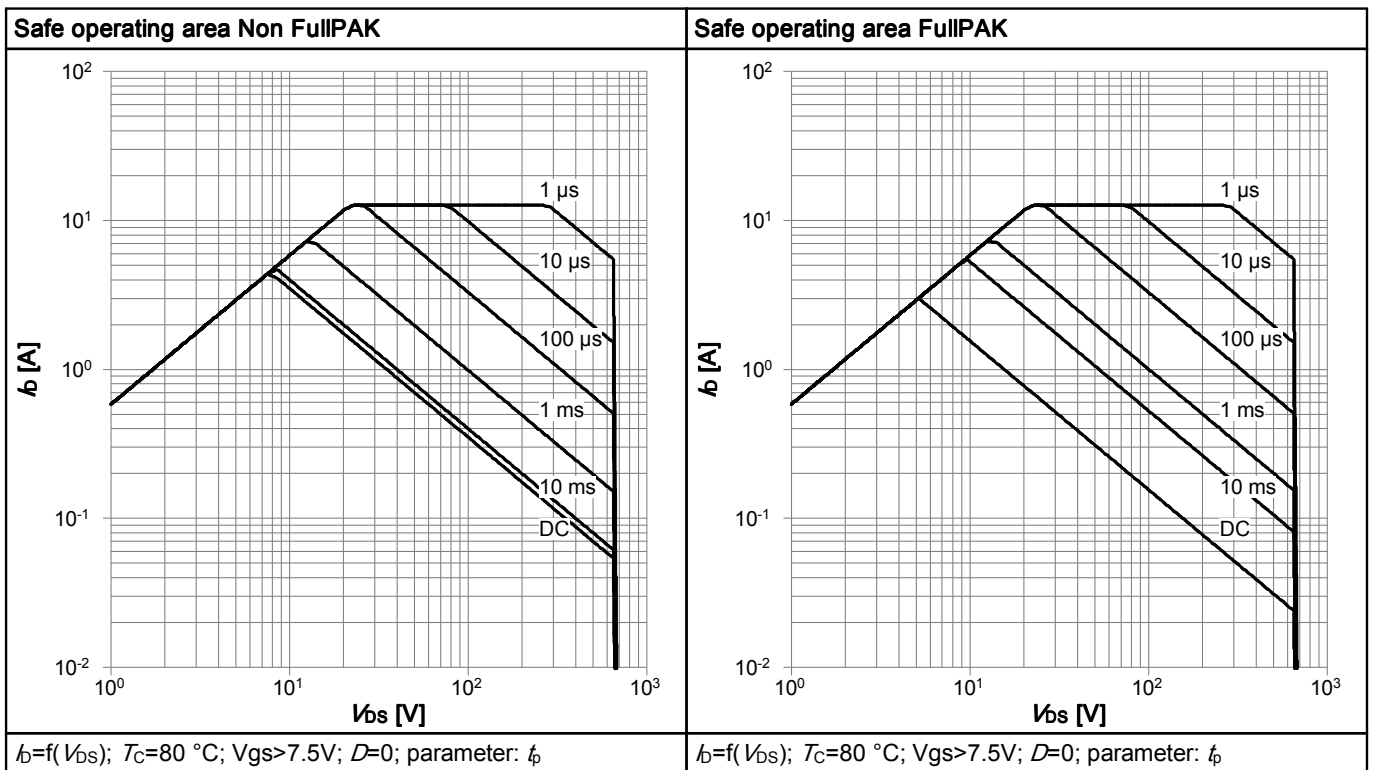

Table 14

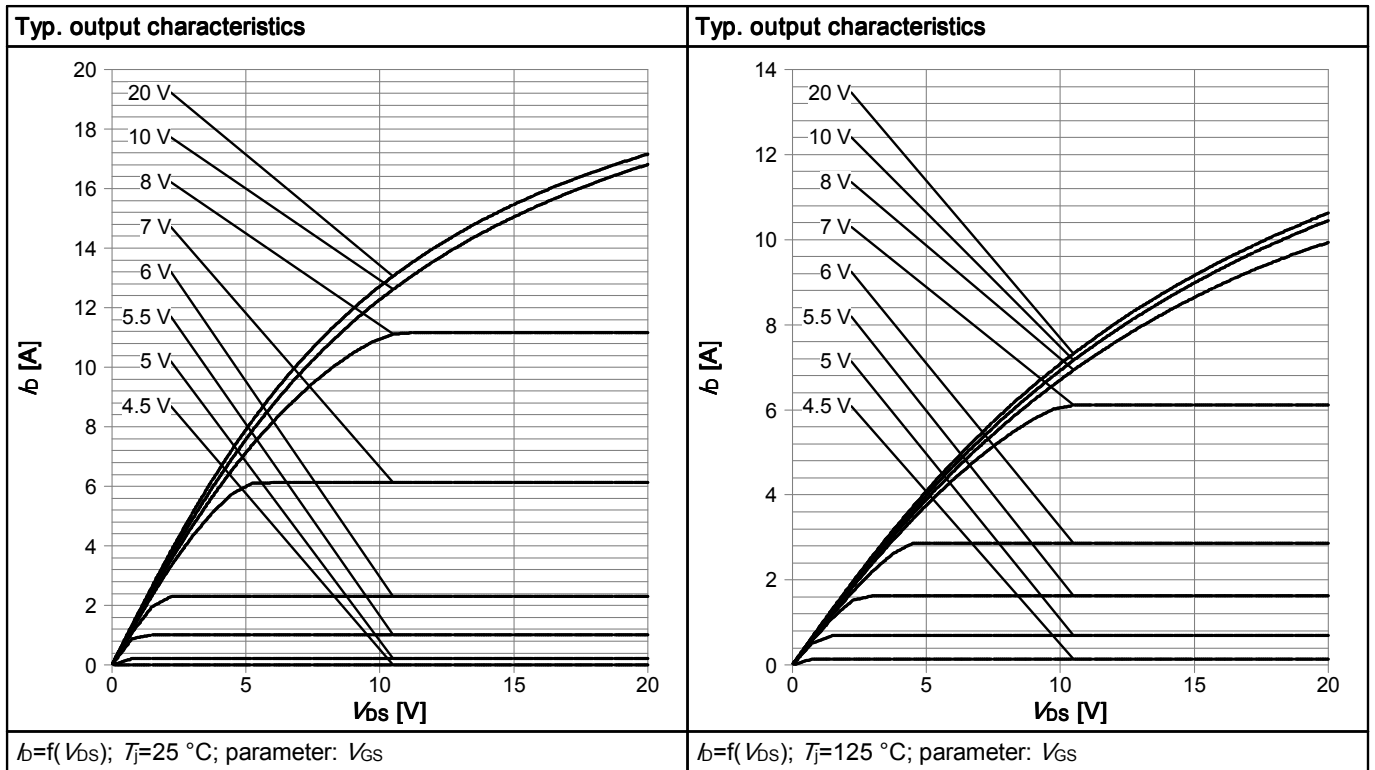

Table 15

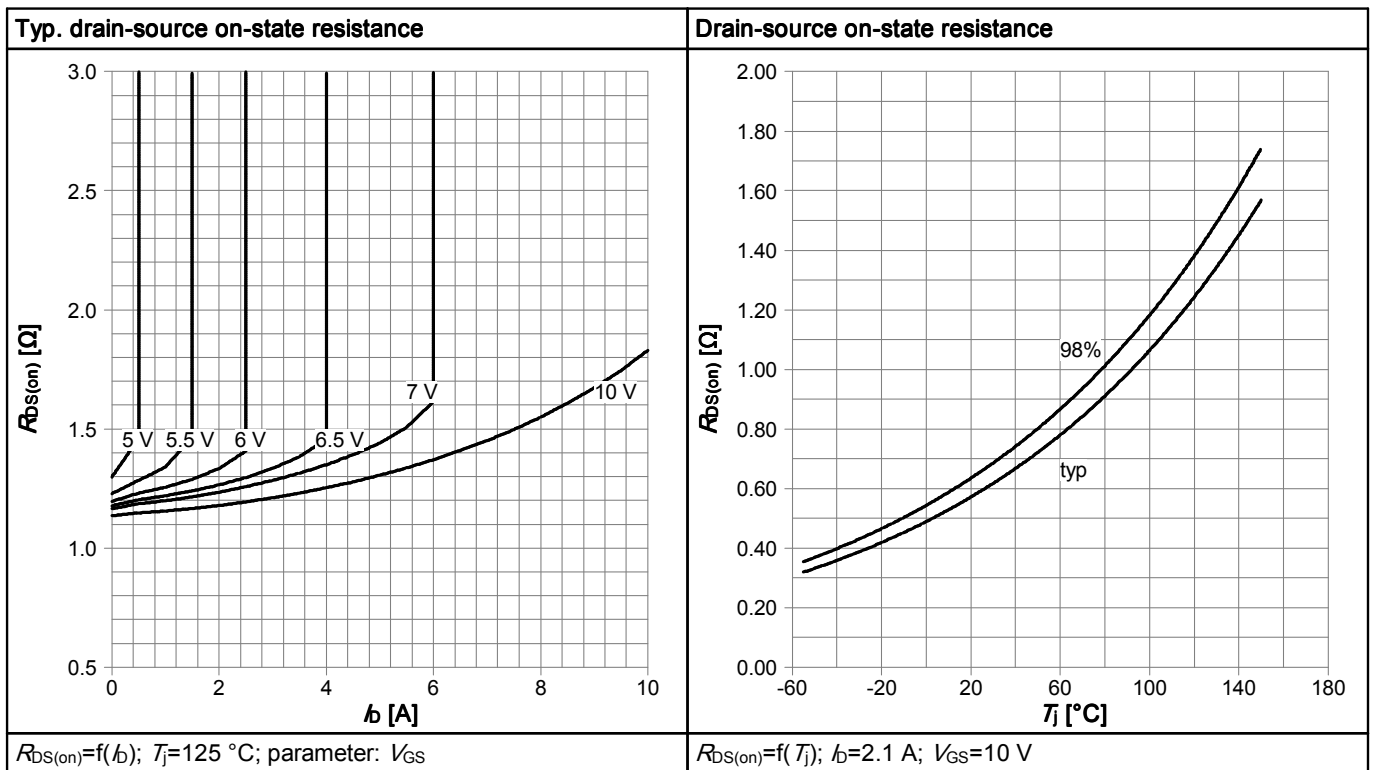

Table 16

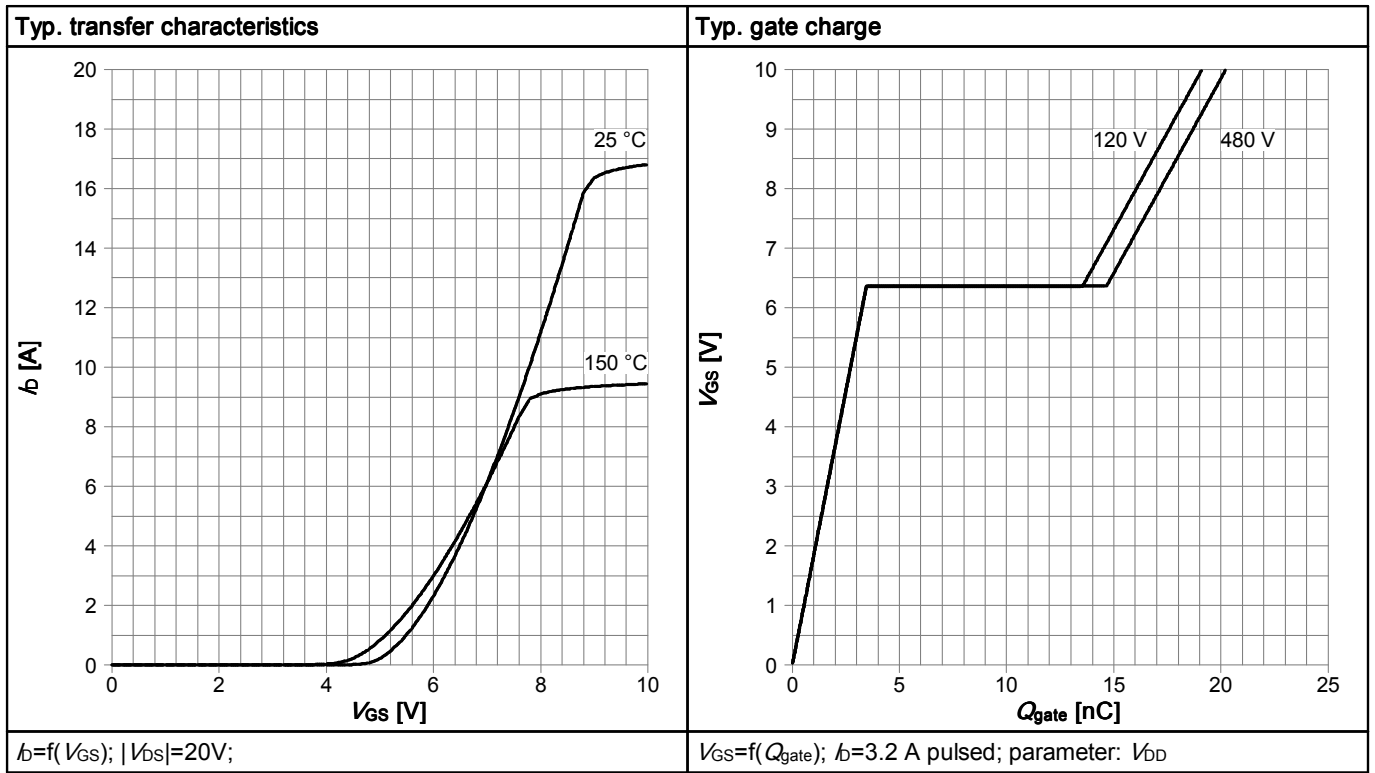
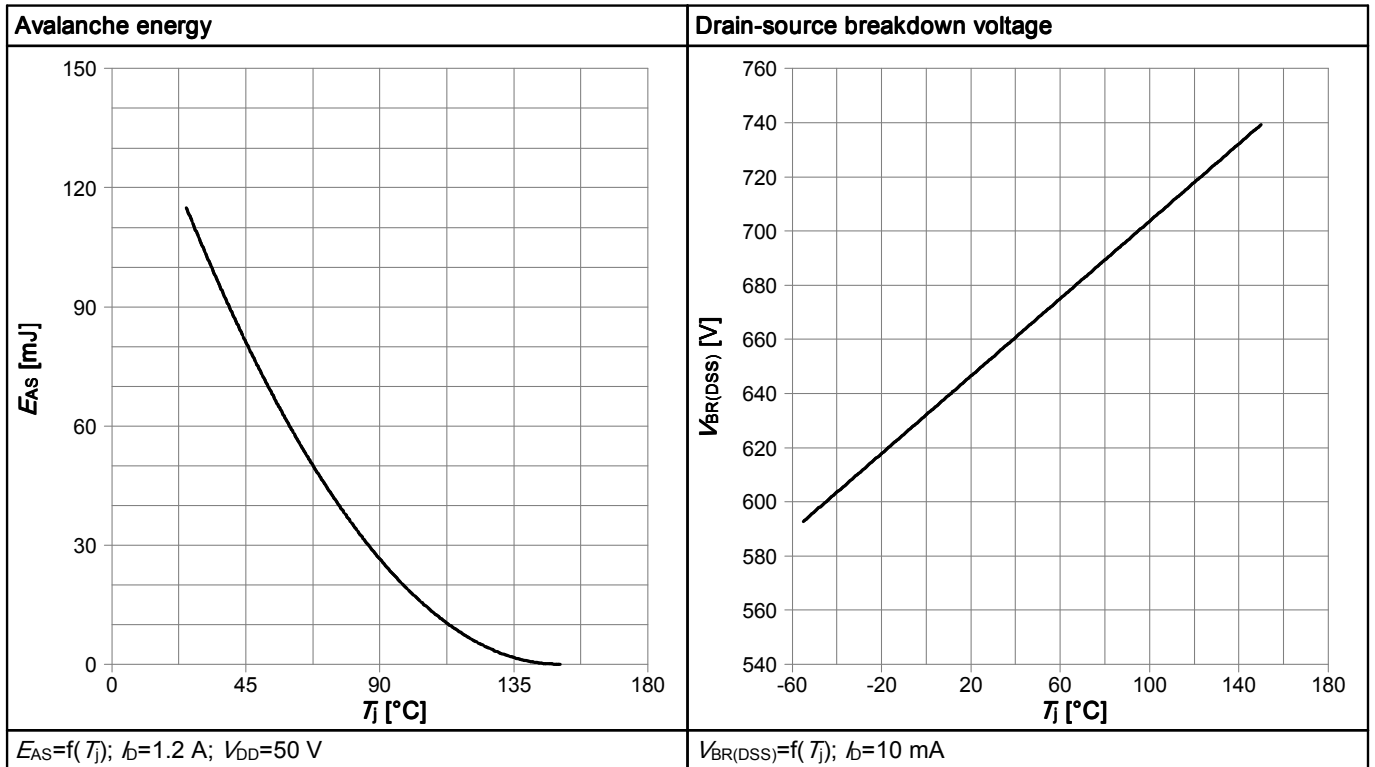
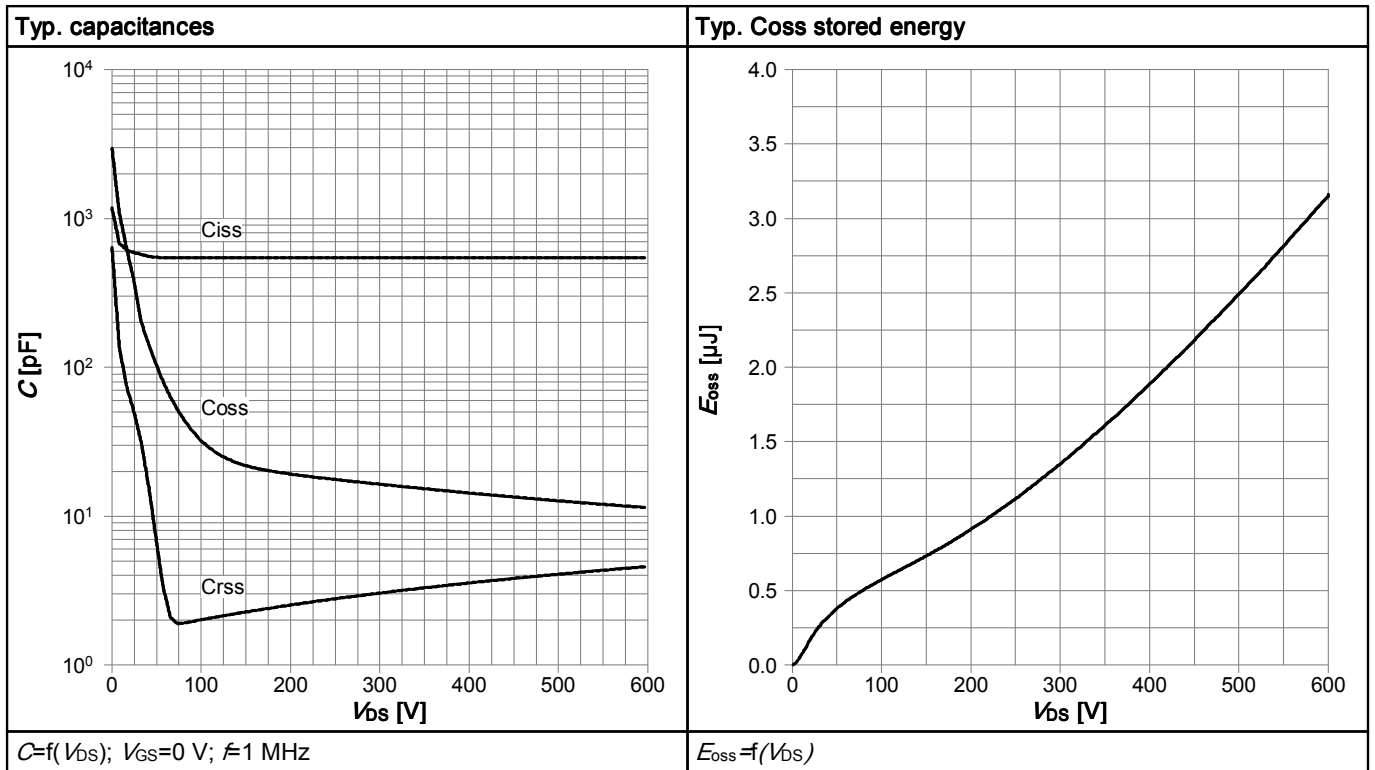

Table 17



**Table 18**



**Table 19**

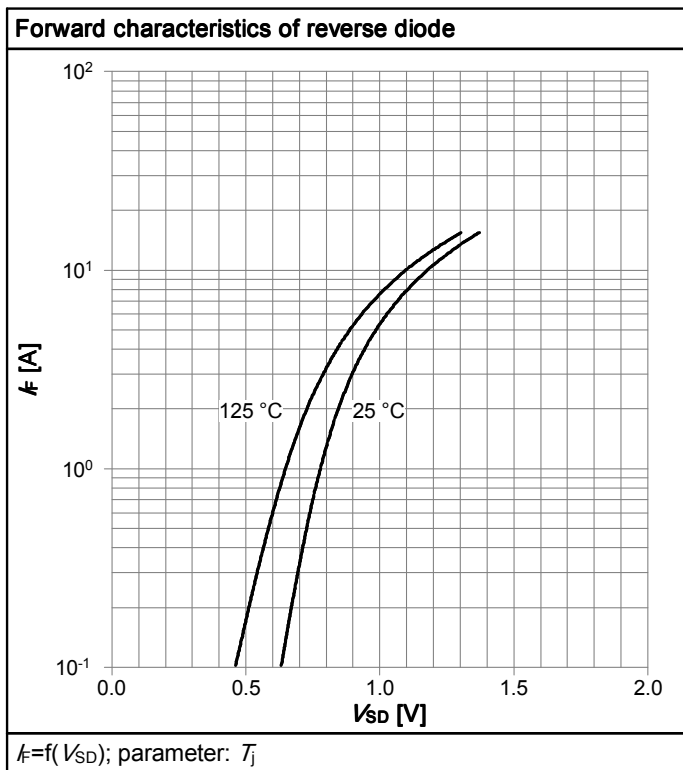

## 6 Test Circuits

**Table 20 Diode\_characteristics**



**Table 21 Switching\_times**



**Table 22 Unclamped\_inductive**



## 7 Package Outlines

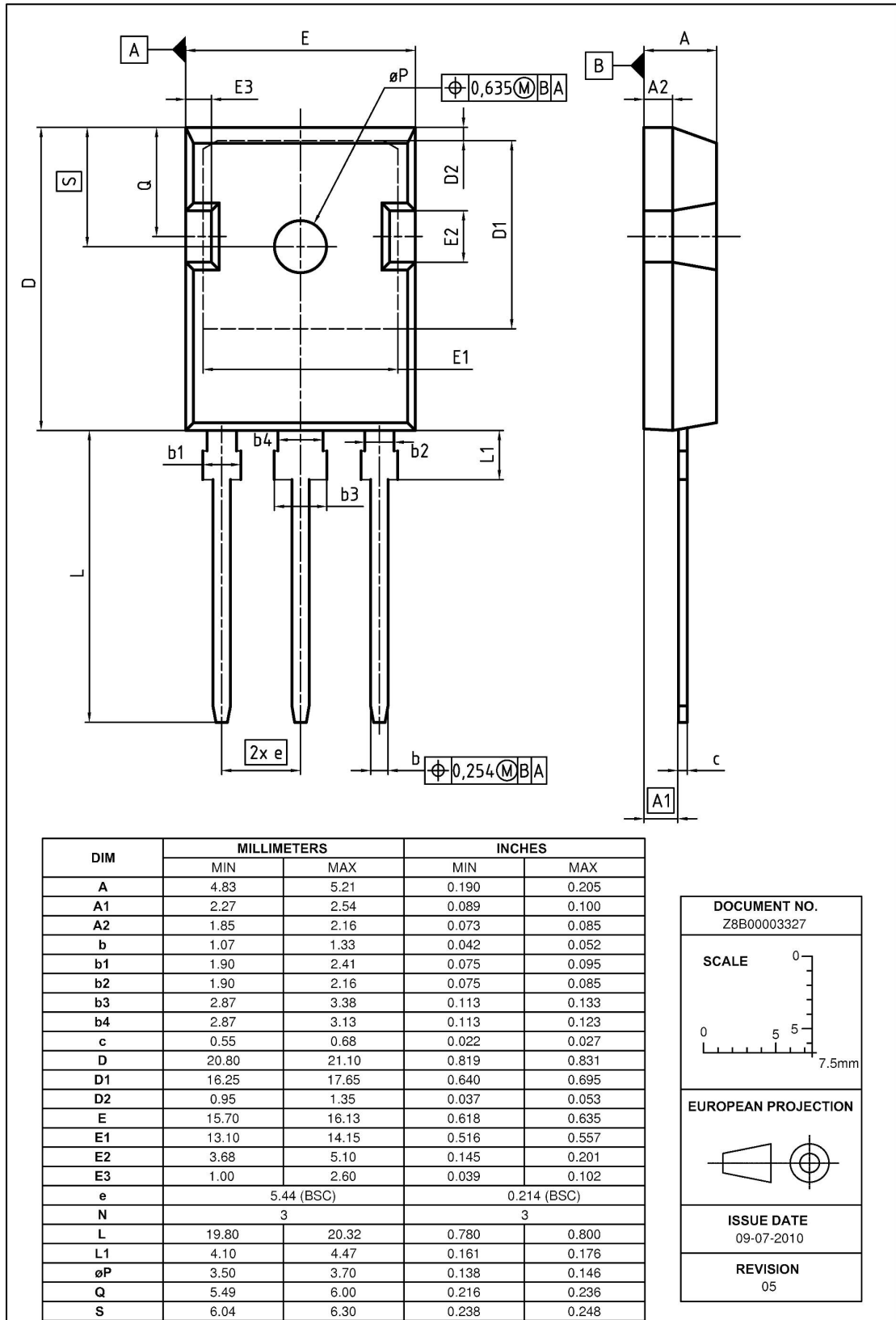

Figure 1 Outline PG-TO 247, dimensions in mm/inches



Figure 2 Outline PG-TO 263, dimensions in mm/inches



Figure 3 Outline PG-TO 220, dimensions in mm/inches





Figure 4 Outline PG-TO 220 FullPAK, dimensions in mm/inches

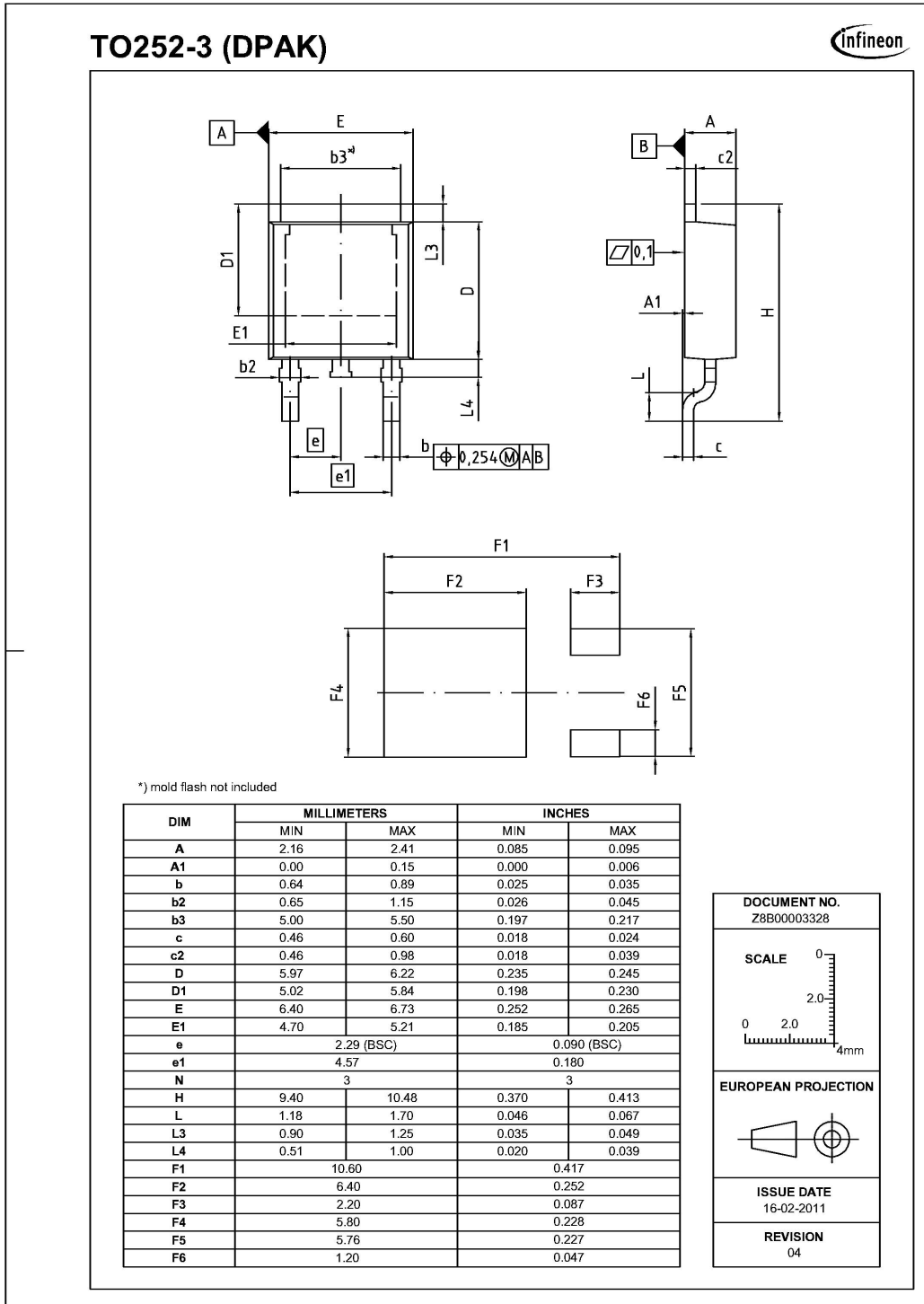

Figure 5 Outline PG-TO 252, dimensions in mm/inches

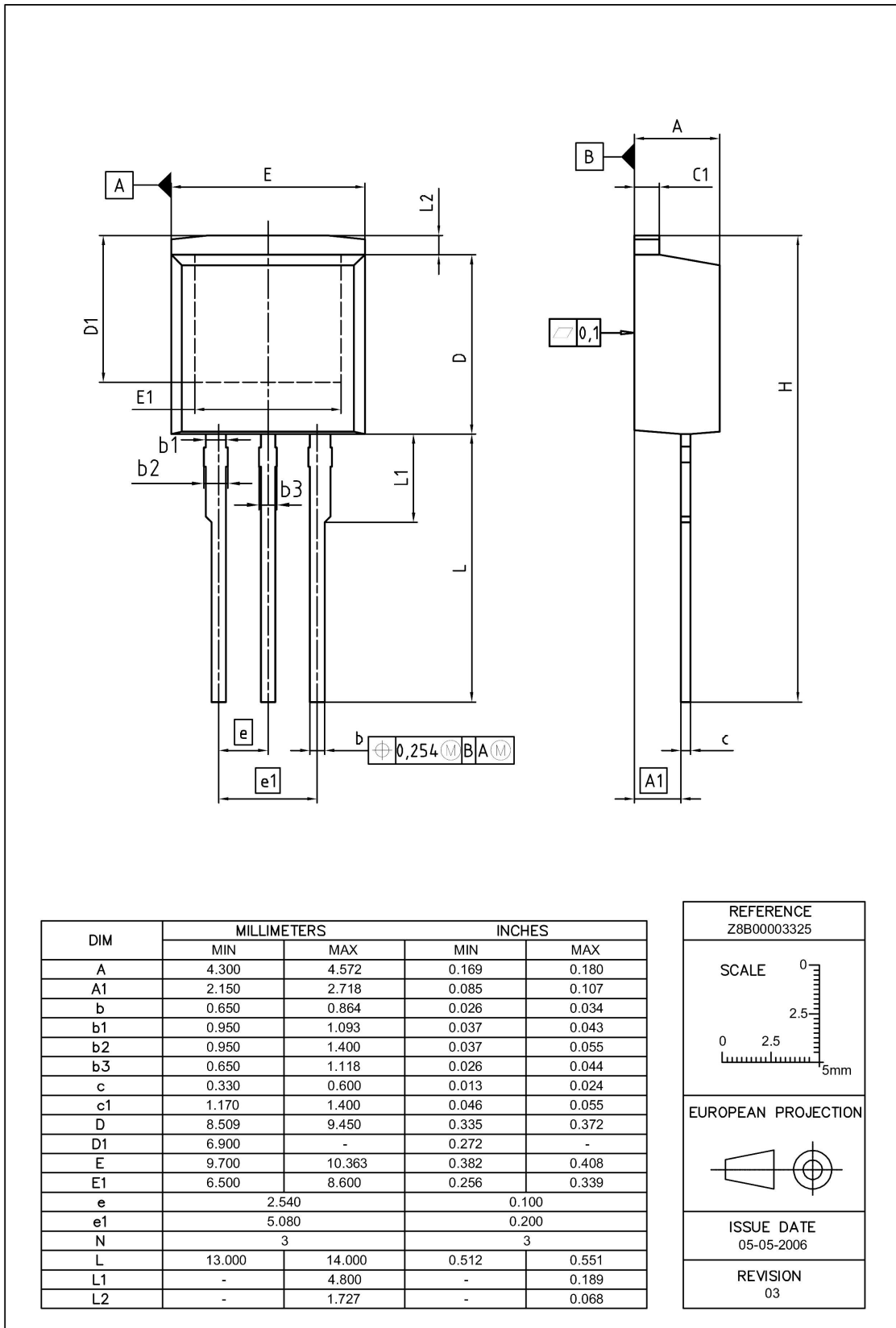

Figure 6 Outline PG-TO 262, dimensions in mm/inches



## 8 Appendix A

### Table 23 Related Links

- **IFX Design Tools:**  
<http://www.infineon.com/cms/en/product/promopages/designtools/index.html>
- **IFX CoolMOS Webpage:**  
<http://www.infineon.com/cms/en/product/channel.html?channel=ff80808112ab681d0112ab6a628704d8>



## Revision History

IPW65R660CFD, IPB65R660CFD, IPP65R660CFD, IPA65R660CFD, IPD65R660CFD, IPI65R660CFD

**Revision: 2011-09-27, Rev. 2.5**

Previous Revision

Revision	Date	Subjects (major changes since last revision)
2.1	2011-08-29	update to CFD2 standard
2.2	2011-09-15	update pin naming
2.3	2011-09-15	update pin naming
2.4	2011-09-15	release of new pin naming
2.5	2011-09-27	update Igss test condition

### We Listen to Your Comments

Any information within this document that you feel is wrong, unclear or missing at all? Your feedback will help us to continuously improve the quality of this document. Please send your proposal (including a reference to this document) to: [erratum@infineon.com](mailto:erratum@infineon.com)

**Edition 2011-08-01**

**Published by**

**Infineon Technologies AG**

**81726 München, Germany**

**© 2011 Infineon Technologies AG**

**All Rights Reserved.**

### Legal Disclaimer

The information given in this document shall in no event be regarded as a guarantee of conditions or characteristics. With respect to any examples or hints given herein, any typical values stated herein and/or any information regarding the application of the device, Infineon Technologies hereby disclaims any and all warranties and liabilities of any kind, including without limitation, warranties of non-infringement of intellectual property rights of any third party.

### Information

For further information on technology, delivery terms and conditions and prices please contact your nearest Infineon Technologies Office ([www.infineon.com](http://www.infineon.com)).

### Warnings

Due to technical requirements, components may contain dangerous substances. For information on the types in question, please contact the nearest Infineon Technologies Office.

The Infineon Technologies component described in this Data Sheet may be used in life-support devices or systems and/or automotive, aviation and aerospace applications or systems only with the express written approval of Infineon Technologies, if a failure of such components can reasonably be expected to cause the failure of that life-support, automotive, aviation and aerospace device or system or to affect the safety or effectiveness of that device or system. Life support devices or systems are intended to be implanted in the human body or to support and/or maintain and sustain and/or protect human life. If they fail, it is reasonable to assume that the health of the user or other persons may be endangered.

# Mouser Electronics

Authorized Distributor

Click to View Pricing, Inventory, Delivery & Lifecycle Information:

[Infineon:](#)

[IPB65R660CFD](#) [IPI65R660CFD](#) [IPW65R660CFD](#) [IPD65R660CFD](#) [IPP65R660CFD](#)