

Fast Switching Emitter Controlled Diode
Product Summary

Features

- 600V Emitter Controlled technology
- Fast recovery
- Soft switching
- Low reverse recovery charge
- Low forward voltage
- Easy paralleling
- Pb-free lead plating; RoHS compliant
- Halogen-free according to IEC61249-2-21
- Qualified according to JEDEC for target applications

V_{RRM}	600	V
I_F	15	A
V_F	1.5	V
T_{jmax}	175	°C



Type	Package	Ordering Code	Marking	Pin 1	PIN 2	PIN 3
IDP15E60	PG-TO220-2	-	D15E60	C	A	-

Maximum Ratings, at $T_j = 25\text{ °C}$, unless otherwise specified

Parameter	Symbol	Value	Unit
Repetitive peak reverse voltage	V_{RRM}	600	V
Continuous forward current $T_C = 25\text{ °C}$ $T_C = 90\text{ °C}$	I_F	29.2 19.6	A
Surge non repetitive forward current $T_C = 25\text{ °C}$, $t_p = 10\text{ ms}$, sine halfwave	I_{FSM}	60	A
Maximum repetitive forward current $T_C = 25\text{ °C}$, t_p limited by $t_{j,max}$, $D = 0.5$	I_{FRM}	45	A
Power dissipation $T_C = 25\text{ °C}$ $T_C = 90\text{ °C}$	P_{tot}	83.3 47.2	W
Operating junction temperature	T_j	-40...+175	°C
Storage temperature	T_{stg}	-55...+150	
Soldering temperature 1.6mm (0.063 in.) from case for 10 s	T_S	260	

Thermal Characteristics

Parameter	Symbol	Values			Unit
		min.	typ.	max.	
Characteristics					
Thermal resistance, junction - case	R_{thJC}	-	-	1.8	K/W
Thermal resistance, junction - ambient, leaded	R_{thJA}	-	-	62	
SMD version, device on PCB: @ min. footprint @ 6 cm ² cooling area ¹⁾	R_{thJA}	-	-	62	
		-	35	-	

Electrical Characteristics, at $T_j = 25\text{ }^\circ\text{C}$, unless otherwise specified

Parameter	Symbol	Values			Unit
		min.	typ.	max.	
Static Characteristics					
Reverse leakage current $V_R=600\text{V}$, $T_j=25\text{ }^\circ\text{C}$ $V_R=600\text{V}$, $T_j=150\text{ }^\circ\text{C}$	I_R	-	-	50 1250	μA
Forward voltage drop $I_F=15\text{A}$, $T_j=25\text{ }^\circ\text{C}$ $I_F=15\text{A}$, $T_j=150\text{ }^\circ\text{C}$	V_F	-	1.5 1.5	2 -	V

⁰J-STD20 and JESD22

¹Device on 40mm*40mm*1.5mm epoxy PCB FR4 with 6cm² (one layer, 70 μm thick) copper area for drain connection. PCB is vertical without blown air.

Electrical Characteristics, at $T_j = 25\text{ °C}$, unless otherwise specified

Parameter	Symbol	Values			Unit
		min.	typ.	max.	
Dynamic Characteristics					
Reverse recovery time $V_R=400\text{V}$, $I_F=15\text{A}$, $di_F/dt=1000\text{A}/\mu\text{s}$, $T_j=25\text{°C}$ $V_R=400\text{V}$, $I_F=15\text{A}$, $di_F/dt=1000\text{A}/\mu\text{s}$, $T_j=125\text{°C}$ $V_R=400\text{V}$, $I_F=15\text{A}$, $di_F/dt=1000\text{A}/\mu\text{s}$, $T_j=150\text{°C}$	t_{rr}	-	87 124 131	-	ns
Peak reverse current $V_R=400\text{V}$, $I_F = 15\text{A}$, $di_F/dt=1000\text{A}/\mu\text{s}$, $T_j=25\text{°C}$ $V_R=400\text{V}$, $I_F = 15\text{A}$, $di_F/dt=1000\text{A}/\mu\text{s}$, $T_j=125\text{°C}$ $V_R=400\text{V}$, $I_F = 15\text{A}$, $di_F/dt=1000\text{A}/\mu\text{s}$, $T_j=150\text{°C}$	I_{rrm}	-	13.7 16.4 19.3	-	A
Reverse recovery charge $V_R=400\text{V}$, $I_F=15\text{A}$, $di_F/dt=1000\text{A}/\mu\text{s}$, $T_j=25\text{°C}$ $V_R=400\text{V}$, $I_F = 15\text{A}$, $di_F/dt=1000\text{A}/\mu\text{s}$, $T_j=125\text{°C}$ $V_R=400\text{V}$, $I_F = 15\text{A}$, $di_F/dt=1000\text{A}/\mu\text{s}$, $T_j=150\text{°C}$	Q_{rr}	-	595 995 1104	-	nC
Reverse recovery softness factor $V_R=400\text{V}$, $I_F=15\text{A}$, $di_F/dt=1000\text{A}/\mu\text{s}$, $T_j=25\text{°C}$ $V_R=400\text{V}$, $I_F=15\text{A}$, $di_F/dt=1000\text{A}/\mu\text{s}$, $T_j=125\text{°C}$ $V_R=400\text{V}$, $I_F=15\text{A}$, $di_F/dt=1000\text{A}/\mu\text{s}$, $T_j=150\text{°C}$	S	-	3.6 4.3 4.5	-	

1 Power dissipation

$$P_{\text{tot}} = f(T_C)$$

parameter: $T_j \leq 175^\circ\text{C}$

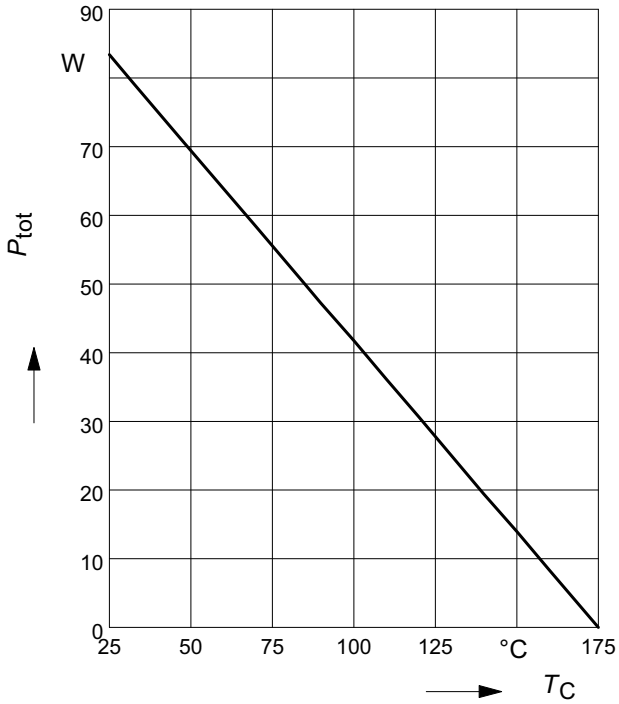

2 Diode forward current

$$I_F = f(T_C)$$

parameter: $T_j \leq 175^\circ\text{C}$

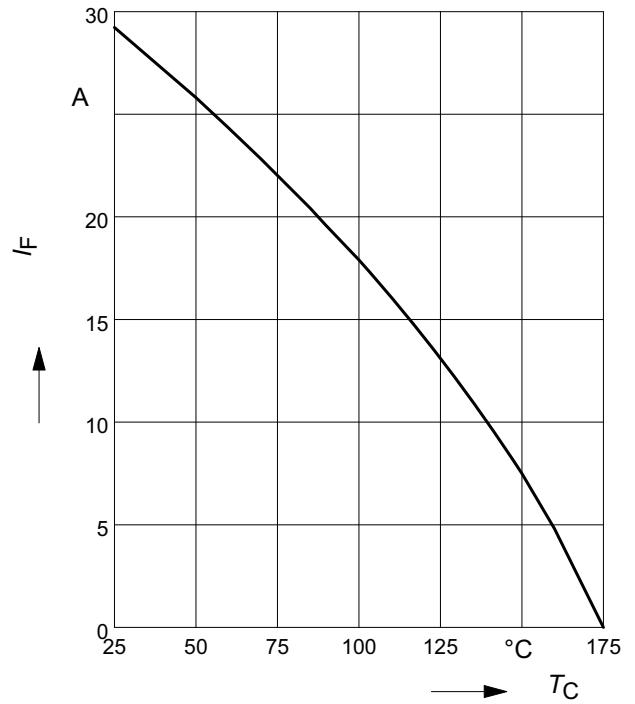

3 Typ. diode forward current

$$I_F = f(V_F)$$

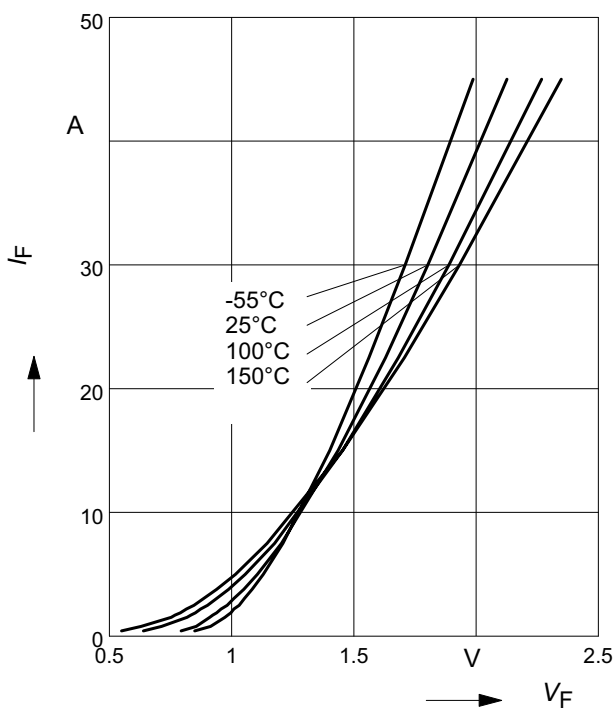

4 Typ. diode forward voltage

$$V_F = f(T_j)$$

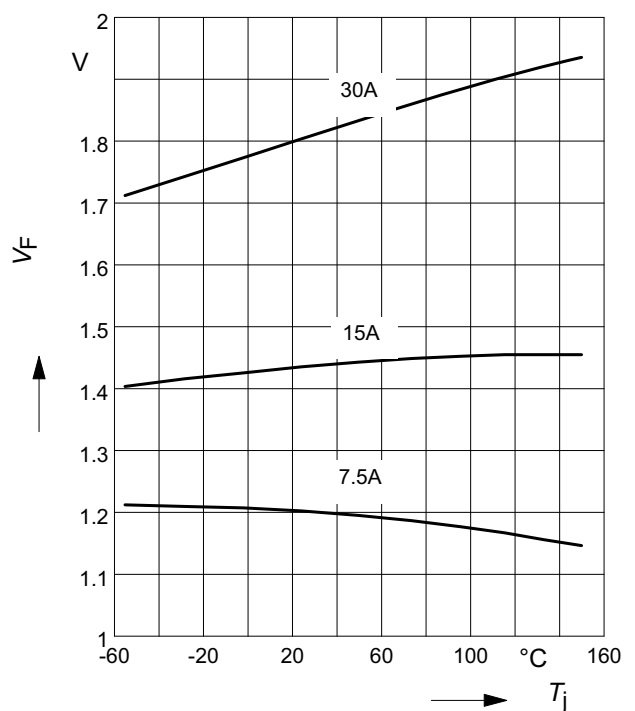

5 Typ. reverse recovery time

$$t_{rr} = f(dI_F/dt)$$

parameter: $V_R = 400V, T_j = 125^\circ C$

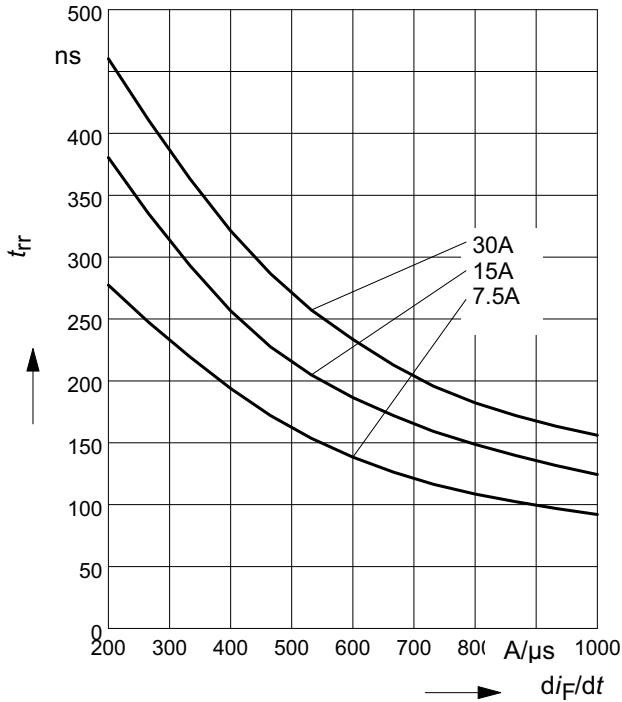

6 Typ. reverse recovery charge

$$Q_{rr} = f(dI_F/dt)$$

parameter: $V_R = 400V, T_j = 125^\circ C$

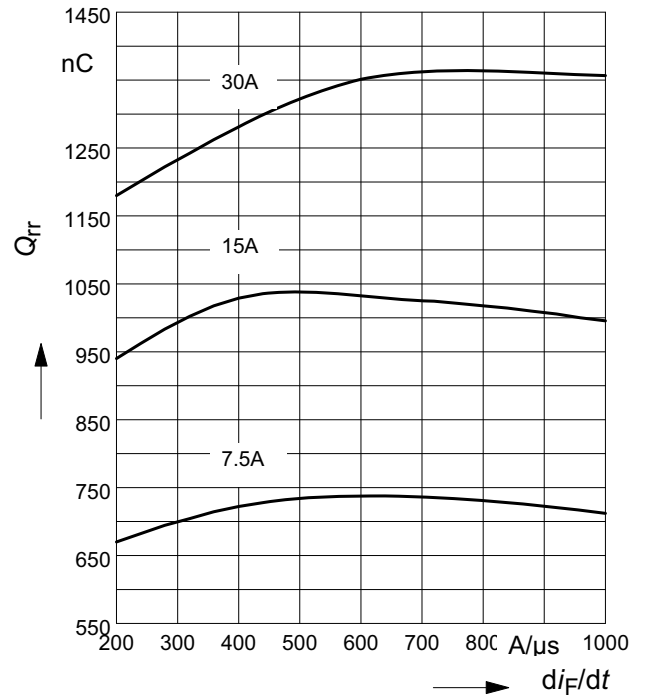

7 Typ. reverse recovery current

$$I_{rr} = f(dI_F/dt)$$

parameter: $V_R = 400V, T_j = 125^\circ C$

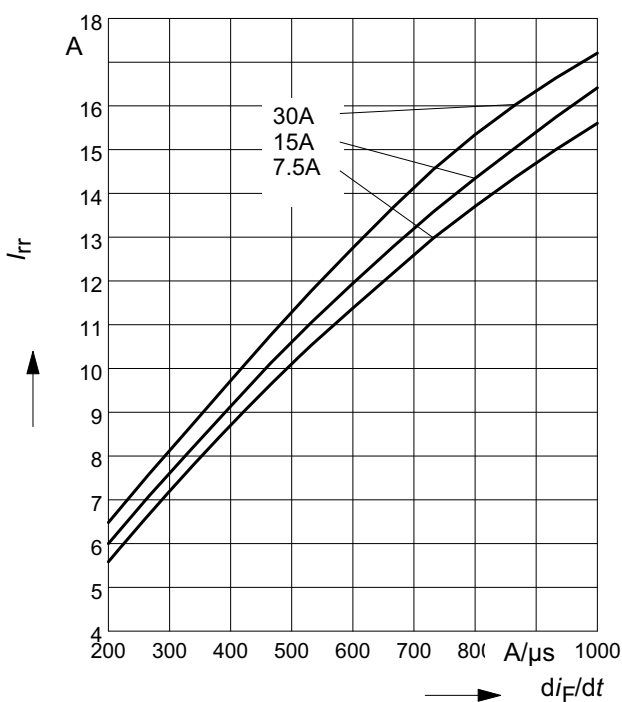

8 Typ. reverse recovery softness factor

$$S = f(dI_F/dt)$$

parameter: $V_R = 400V, T_j = 125^\circ C$

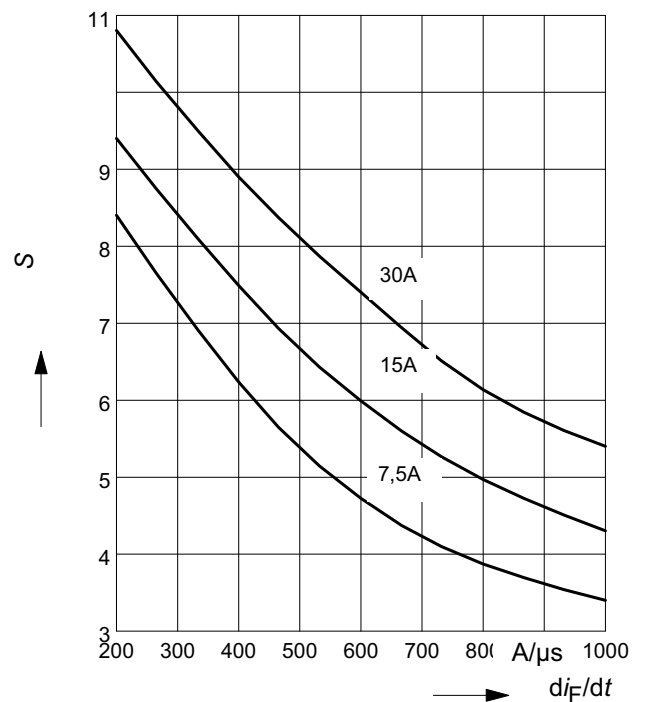

9 Max. transient thermal impedance

$$Z_{thJC} = f(t_p)$$

parameter : $D = t_p/T$

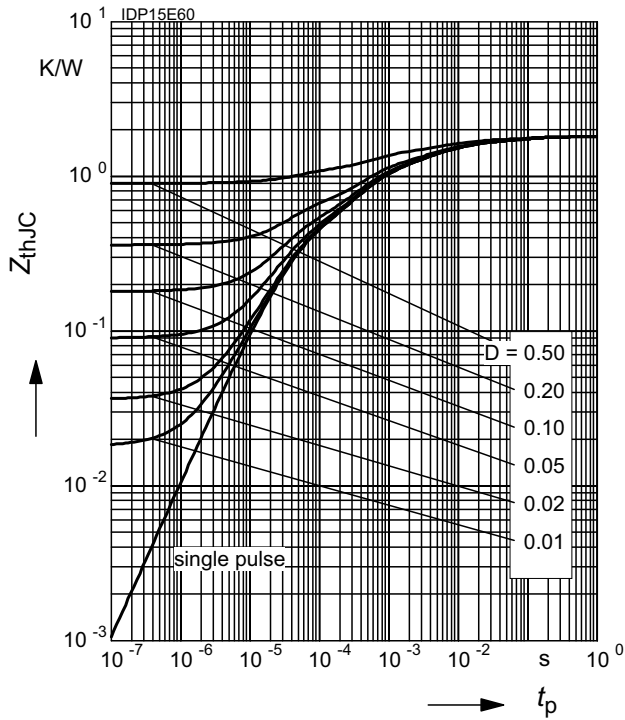

Package Outline: TO220-2

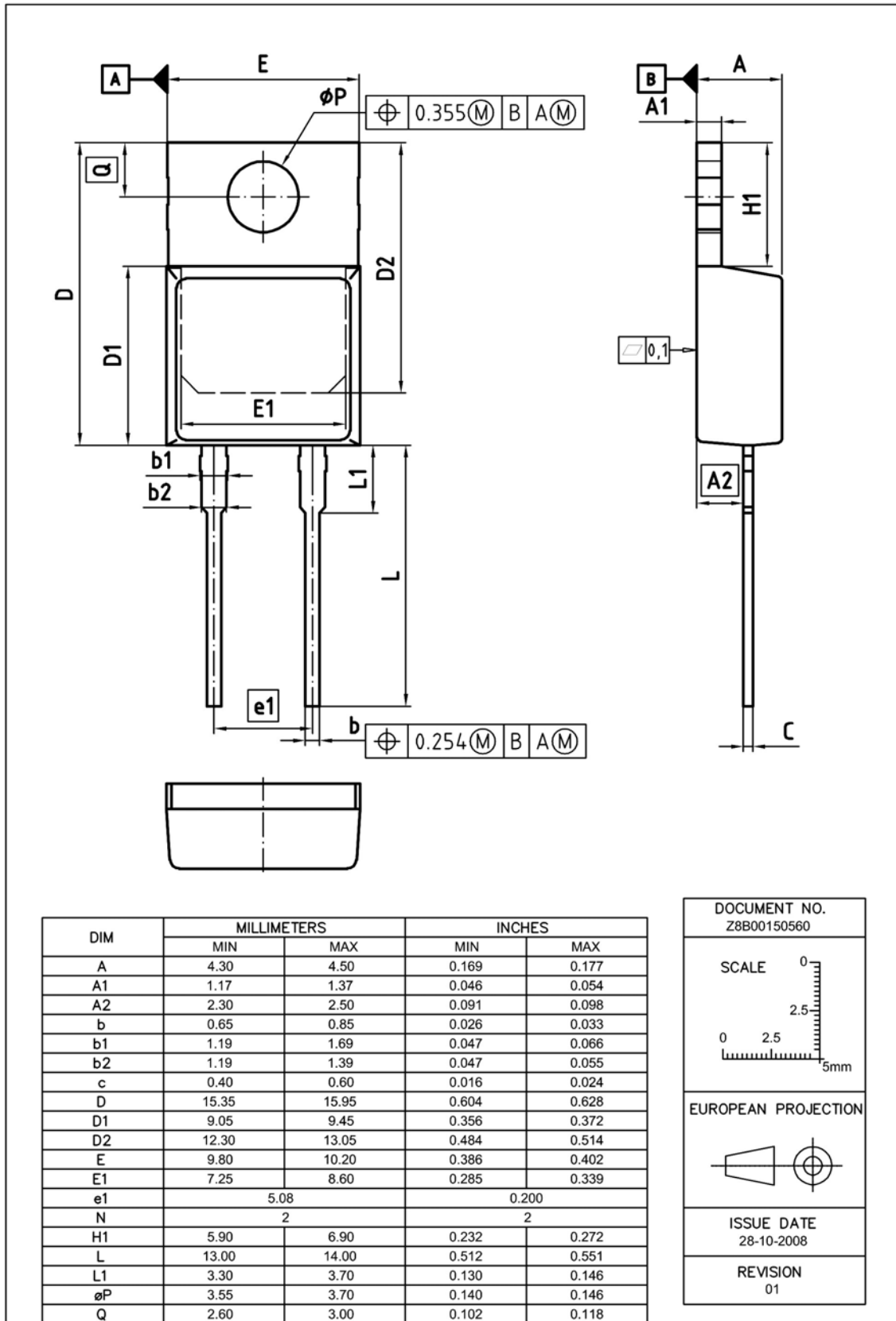

Published by
Infineon Technologies AG
81726 Munich, Germany
© 2013 Infineon Technologies AG
All Rights Reserved.

Legal Disclaimer

The information given in this document shall in no event be regarded as a guarantee of conditions or characteristics. With respect to any examples or hints given herein, any typical values stated herein and/or any information regarding the application of the device, Infineon Technologies hereby disclaims any and all warranties and liabilities of any kind, including without limitation, warranties of non-infringement of intellectual property rights of any third party.

Information

For further information on technology, delivery terms and conditions and prices, please contact the nearest Infineon Technologies Office (www.infineon.com).

Warnings

Due to technical requirements, components may contain dangerous substances. For information on the types in question, please contact the nearest Infineon Technologies Office.

The Infineon Technologies component described in this Data Sheet may be used in life-support devices or systems and/or automotive, aviation and aerospace applications or systems only with the express written approval of Infineon Technologies, if a failure of such components can reasonably be expected to cause the failure of that life-support, automotive, aviation and aerospace device or system or to affect the safety or effectiveness of that device or system. Life support devices or systems are intended to be implanted in the human body or to support and/or maintain and sustain and/or protect human life. If they fail, it is reasonable to assume that the health of the user or other persons may be endangered.

Mouser Electronics

Authorized Distributor

Click to View Pricing, Inventory, Delivery & Lifecycle Information:

[Infineon:](#)

[IDP15E60](#)