

**Low Loss IGBT: IGBT in TrenchStop® and Fieldstop technology**

- TrenchStop® and Fieldstop technology for 1000 V applications offers:
  - low  $V_{CEsat}$
  - very tight parameter distribution
  - high ruggedness, temperature stable behavior
  - positive temperature coefficient in  $V_{CEsat}$
- Designed for:
  - frequency Converters
  - uninterrupted Power Supply
- Low EMI
- Low gate charge
- Qualified according to JEDEC for target applications
- Pb-free lead plating; RoHS compliant
- Complete product spectrum and PSpice Models:  
<http://www.infineon.com/igbt/>

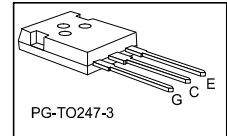
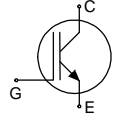

Type	$V_{CE}$	$I_C$	$V_{CEsat}, T_{vj}=25^\circ\text{C}$	$T_{vjmax}$	Marking	Package
IGW30N100T	1000V	30A	1.55V	175°C	G30T100	PG-TO247-3

**Maximum ratings**

Parameter	Symbol	Value	Unit
Collector-emitter voltage	$V_{CE}$	1000	V
DC collector current, limited by $T_{vjmax}$ $T_C = 25^\circ\text{C}$ $T_C = 100^\circ\text{C}$	$I_C$	60.0 30.0	A
Pulsed collector current, $t_p$ limited by $T_{vjmax}$	$I_{Cpuls}$	90.0	A
Turn off safe operating area $V_{CE} = 1000\text{V}, T_{vj}= 175^\circ\text{C}$	-	90.0	A
Gate-emitter voltage Transient Gate-emitter voltage ( $t_p = 5\mu\text{s}, D < 0.010$ )	$V_{GE}$	$\pm 20$ $\pm 25$	V
Power dissipation $T_C = 25^\circ\text{C}$	$P_{tot}$	412.0	W
Operating junction temperature	$T_{vj}$	-55...+175	°C
Storage temperature	$T_{stg}$	-55...+175	°C
Soldering temperature, wavesoldering 1.6 mm (0.063 in.) from case for 10s		260	°C
Mounting torque, M3 screw Maximum of mounting processes: 3	$M$	0.6	Nm

**Thermal Resistance**

Parameter	Symbol	Conditions	Max. Value	Unit
<b>Characteristic</b>				
IGBT thermal resistance, junction - case	$R_{th(j-c)}$		0.36	K/W
Thermal resistance junction - ambient	$R_{th(j-a)}$		40	K/W

**Electrical Characteristic, at  $T_{vj} = 25^{\circ}\text{C}$ , unless otherwise specified**

Parameter	Symbol	Conditions	Value			Unit
			min.	typ.	max.	
<b>Static Characteristic</b>						
Collector-emitter breakdown voltage	$V_{(BR)CES}$	$V_{GE} = 0\text{V}, I_C = 0.50\text{mA}$	1000	-	-	V
Collector-emitter saturation voltage	$V_{CEsat}$	$V_{GE} = 15.0\text{V}, I_C = 30.0\text{A}$ $T_{vj} = 25^{\circ}\text{C}$ $T_{vj} = 150^{\circ}\text{C}$ $T_{vj} = 175^{\circ}\text{C}$	- - -	1.55 1.70 1.80	1.90 - -	V
Gate-emitter threshold voltage	$V_{GE(th)}$	$I_C = 0.80\text{mA}, V_{CE} = V_{GE}$	5.1	5.8	6.4	V
Zero gate voltage collector current	$I_{CES}$	$V_{CE} = 1000\text{V}, V_{GE} = 0\text{V}$ $T_{vj} = 25^{\circ}\text{C}$ $T_{vj} = 175^{\circ}\text{C}$	- -	- -	50.0 2500.0	$\mu\text{A}$
Gate-emitter leakage current	$I_{GES}$	$V_{CE} = 0\text{V}, V_{GE} = 20\text{V}$	-	-	600	nA
Transconductance	$g_{fs}$	$V_{CE} = 20\text{V}, I_C = 30.0\text{A}$	-	28.0	-	S
Integrated gate resistor	$r_G$			none		$\Omega$

**Electrical Characteristic, at  $T_{vj} = 25^{\circ}\text{C}$ , unless otherwise specified**

Parameter	Symbol	Conditions	Value			Unit
			min.	typ.	max.	
<b>Dynamic Characteristic</b>						
Input capacitance	$C_{ies}$	$V_{CE} = 25\text{V}, V_{GE} = 0\text{V}, f = 1\text{MHz}$	-	3575	-	pF
Output capacitance	$C_{oes}$		-	98	-	
Reverse transfer capacitance	$C_{res}$		-	76	-	
Gate charge	$Q_G$	$V_{CC} = 800\text{V}, I_C = 30.0\text{A},$ $V_{GE} = 15\text{V}$	-	217.0	-	nC
Internal emitter inductance measured 5mm (0.197 in.) from case	$L_E$		-	13.0	-	nH

**Switching Characteristic, Inductive Load, at  $T_{vj} = 25^{\circ}\text{C}$** 

Parameter	Symbol	Conditions	Value			Unit
			min.	typ.	max.	
<b>IGBT Characteristic</b>						
Turn-on delay time	$t_{d(on)}$	$T_{vj} = 25^{\circ}\text{C},$ $V_{CC} = 600\text{V}, I_C = 30.0\text{A},$ $V_{GE} = 0.0/15.0\text{V},$ $r_G = 16.0\Omega, L_{\sigma} = 105\text{nH},$ $C_{\sigma} = 50\text{pF}$ $L_{\sigma}, C_{\sigma}$ from Fig. E Energy losses include "tail" and diode reverse recovery using the IKW30N100T duopak.	-	33	-	ns
Rise time	$t_r$		-	21	-	ns
Turn-off delay time	$t_{d(off)}$		-	535	-	ns
Fall time	$t_f$		-	34	-	ns
Turn-on energy	$E_{on}$		-	2.20	-	mJ
Turn-off energy	$E_{off}$		-	1.60	-	mJ
Total switching energy	$E_{ts}$		-	3.80	-	mJ

**Switching Characteristic, Inductive Load, at  $T_{vj} = 175^{\circ}\text{C}$** 

Parameter	Symbol	Conditions	Value			Unit
			min.	typ.	max.	
<b>IGBT Characteristic</b>						
Turn-on delay time	$t_{d(on)}$	$T_{vj} = 175^{\circ}\text{C}$ , $V_{CC} = 600\text{V}$ , $I_C = 30.0\text{A}$ , $V_{GE} = 0.0/15.0\text{V}$ , $r_G = 16.0\Omega$ , $L_{\sigma} = 105\text{nH}$ , $C_{\sigma} = 50\text{pF}$ Energy losses include "tail" and diode reverse recovery using the IKW30N100T duopak.	-	33	-	ns
Rise time	$t_r$		-	30	-	ns
Turn-off delay time	$t_{d(off)}$		-	610	-	ns
Fall time	$t_f$		-	60	-	ns
Turn-on energy	$E_{on}$		-	3.20	-	mJ
Turn-off energy	$E_{off}$		-	2.40	-	mJ
Total switching energy	$E_{ts}$		-	5.60	-	mJ

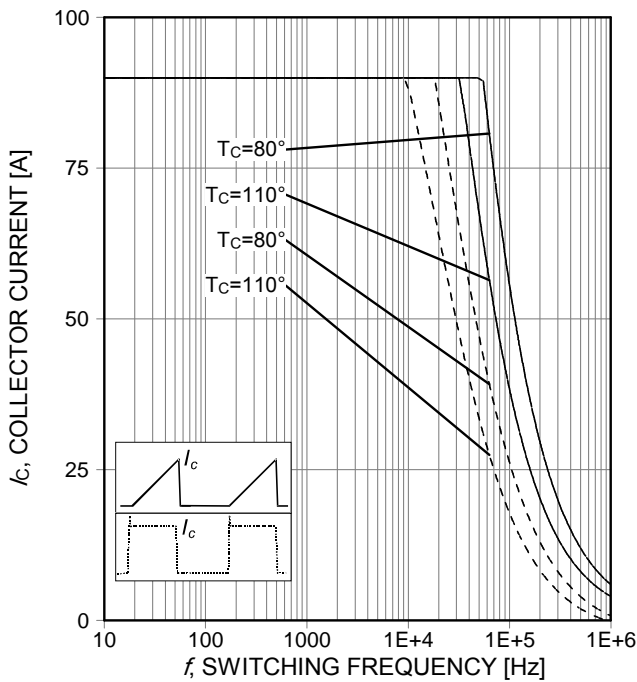

**Figure 1. Collector current as a function of switching frequency**  
 ( $T_j \leq 175^\circ\text{C}$ ,  $D=0.5$ ,  $V_{CE}=600\text{V}$ ,  $V_{GE}=15/0\text{V}$ ,  $R_G=16\Omega$ )

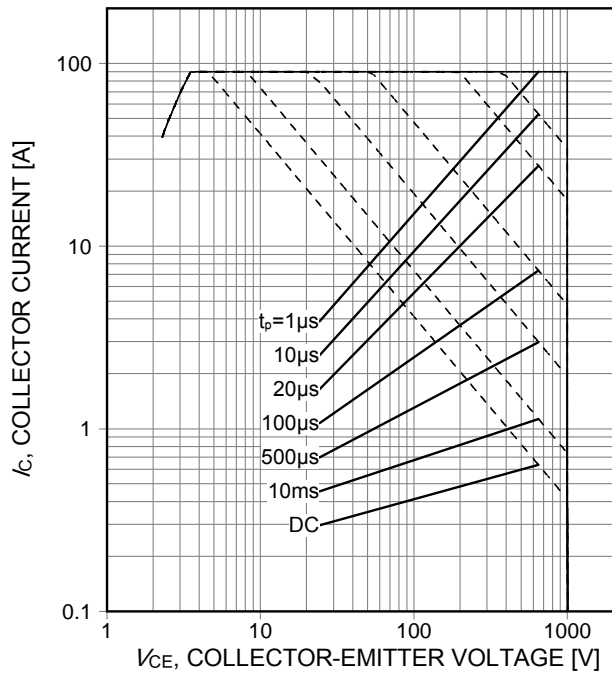

**Figure 2. Forward bias safe operating area**  
 ( $D=0$ ,  $T_C=25^\circ\text{C}$ ,  $T_j \leq 175^\circ\text{C}$ ;  $V_{GE}=15\text{V}$ )

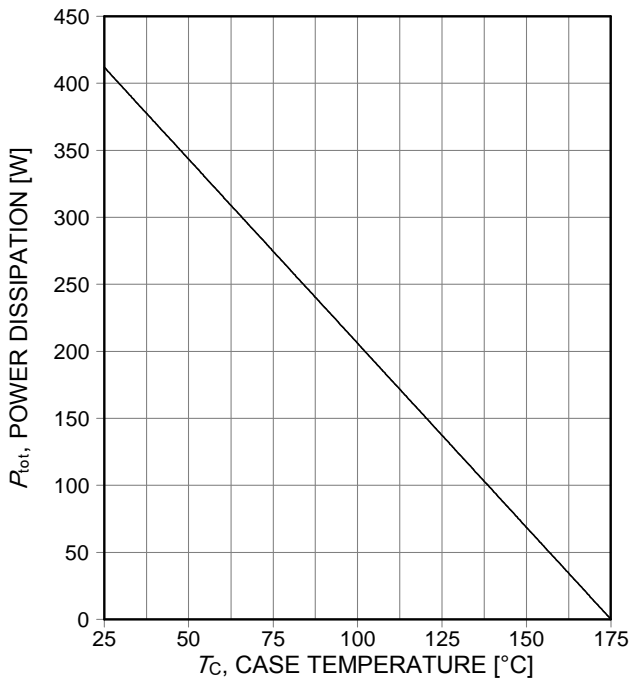

**Figure 3. Power dissipation as a function of case temperature**  
 ( $T_j \leq 175^\circ\text{C}$ )

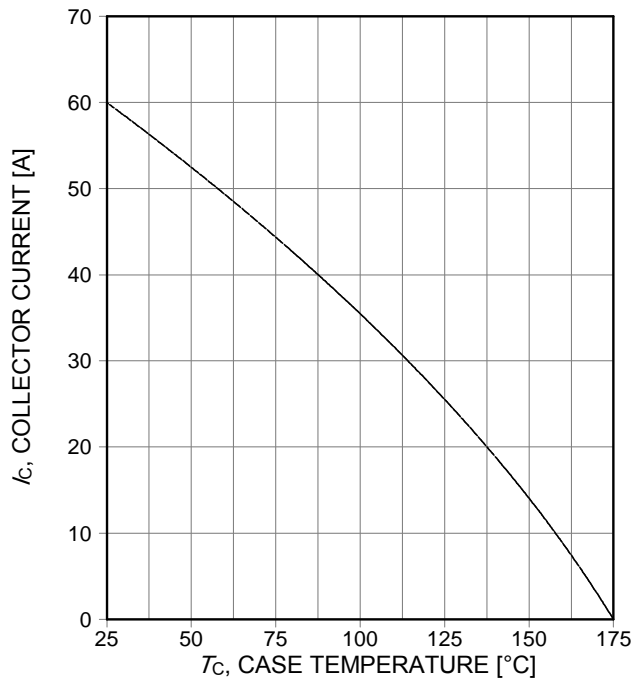

**Figure 4. Collector current as a function of case temperature**  
 ( $V_{GE} \geq 15\text{V}$ ,  $T_j \leq 175^\circ\text{C}$ )

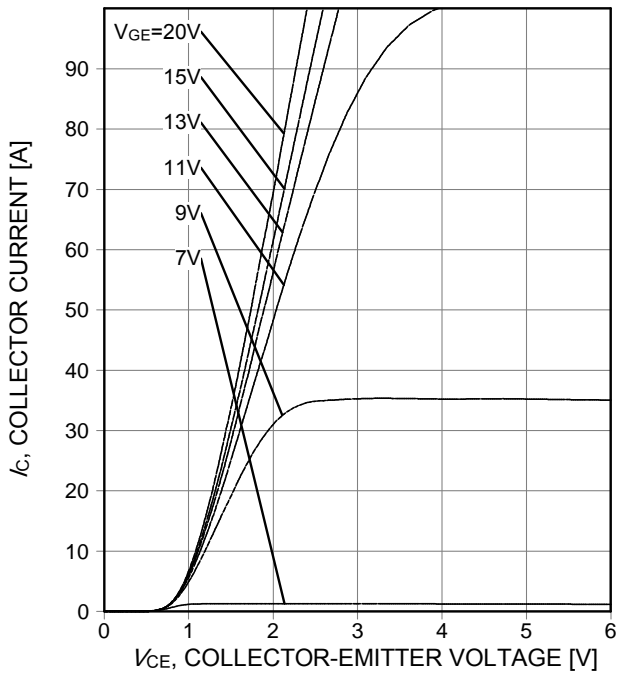

Figure 5. Typical output characteristic ( $T_j=25^\circ\text{C}$ )

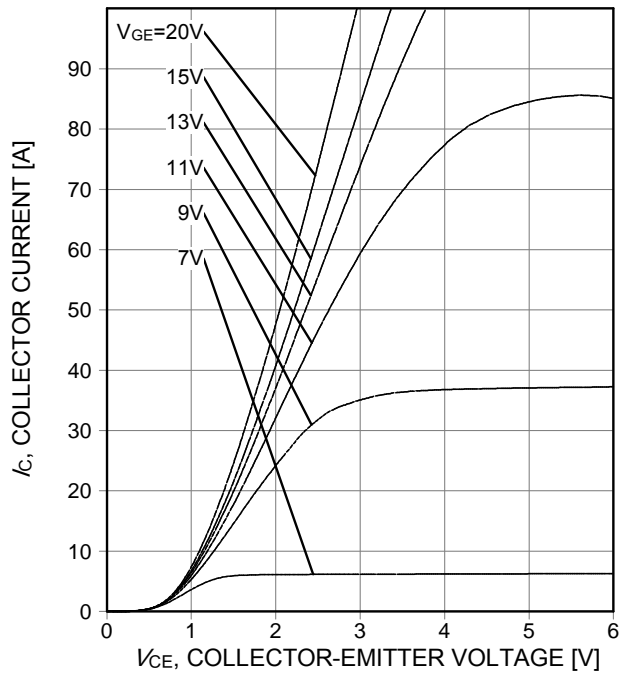

Figure 6. Typical output characteristic ( $T_j=175^\circ\text{C}$ )

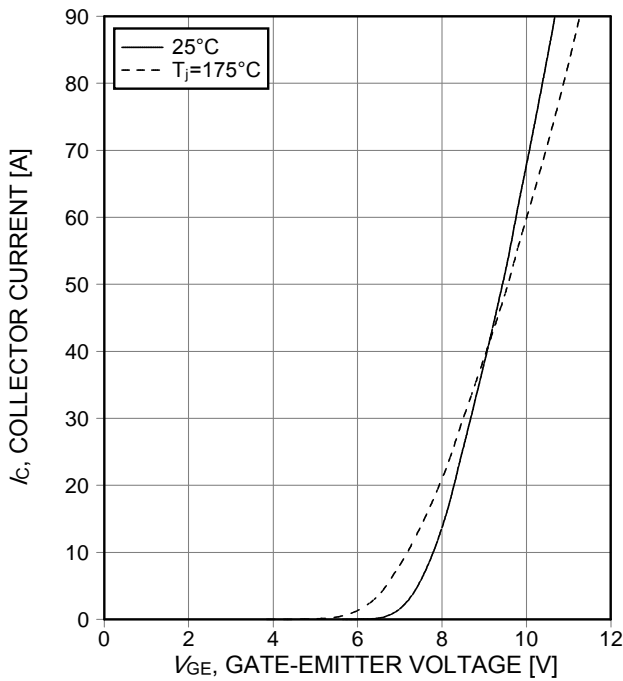

Figure 7. Typical transfer characteristic ( $V_{CE}=20\text{V}$ )

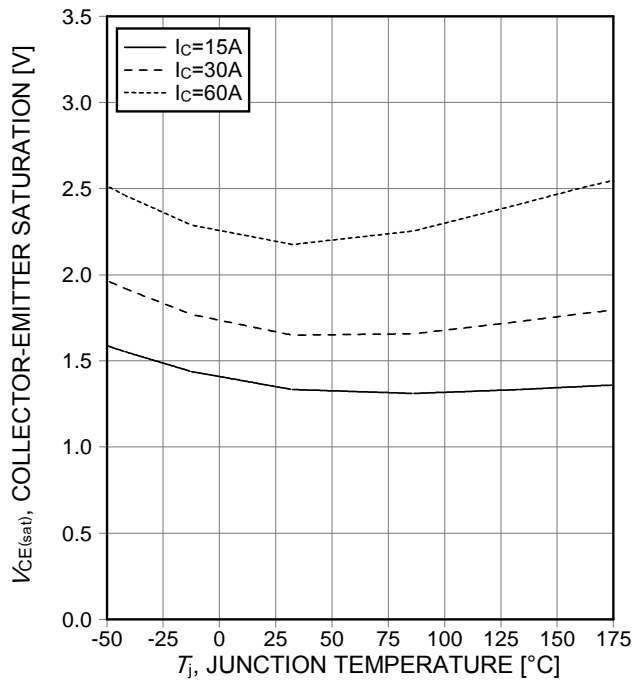
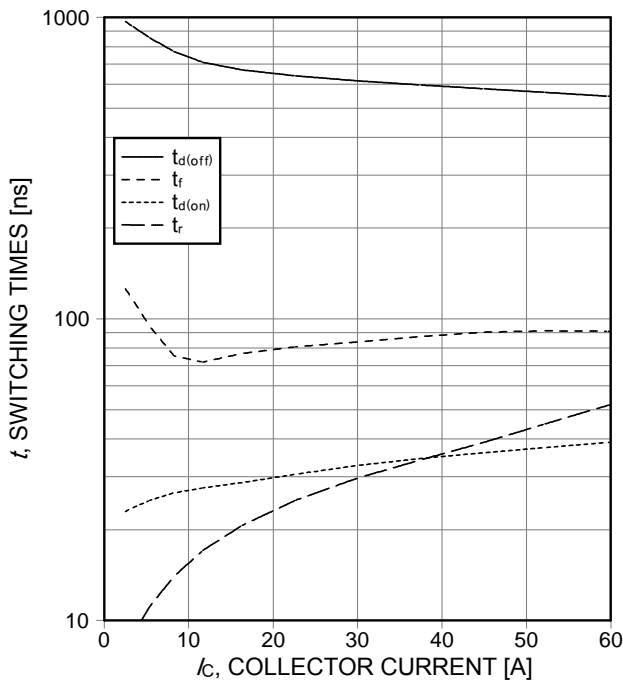
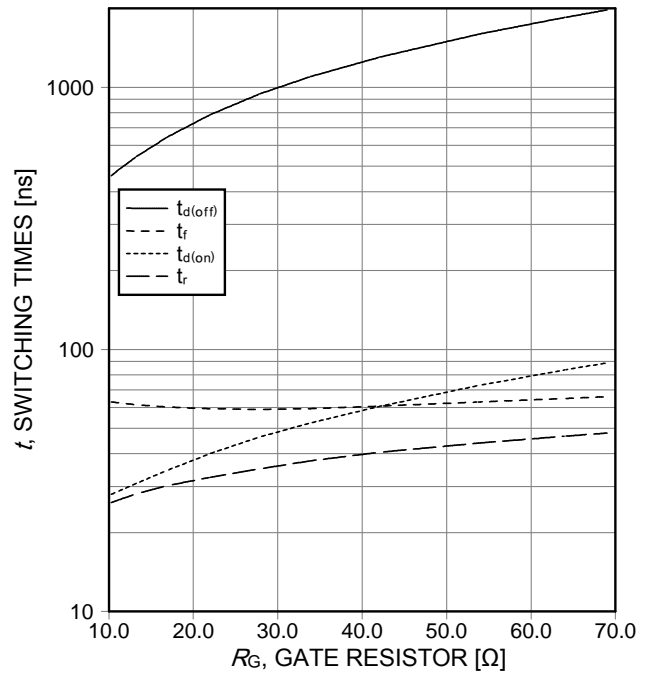

Figure 8. Typical collector-emitter saturation voltage as a function of junction temperature ( $V_{GE}=15\text{V}$ )



**Figure 9. Typical switching times as a function of collector current**  
(inductive load,  $T_j=175^\circ\text{C}$ ,  $V_{CE}=600\text{V}$ ,  $V_{GE}=15/0\text{V}$ ,  $R_G=16\Omega$ , Dynamic test circuit in Figure E)



**Figure 10. Typical switching times as a function of gate resistor**  
(inductive load,  $T_j=175^\circ\text{C}$ ,  $V_{CE}=600\text{V}$ ,  $V_{GE}=15/0\text{V}$ ,  $I_C=30\text{A}$ , Dynamic test circuit in Figure E)

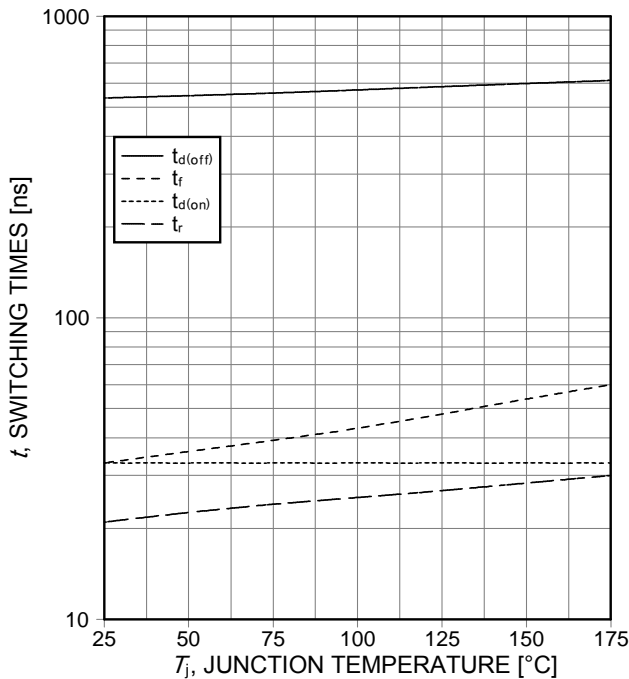

**Figure 11. Typical switching times as a function of junction temperature**  
(inductive load,  $V_{CE}=600\text{V}$ ,  $V_{GE}=15/0\text{V}$ ,  $I_C=30\text{A}$ ,  $R_G=16\Omega$ , Dynamic test circuit in Figure E)

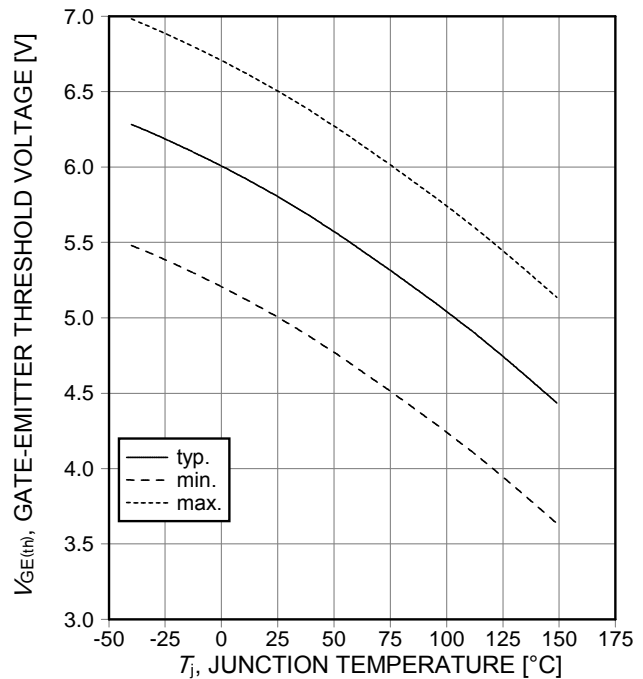

**Figure 12. Gate-emitter threshold voltage as a function of junction temperature**  
( $I_C=0.7\text{mA}$ )

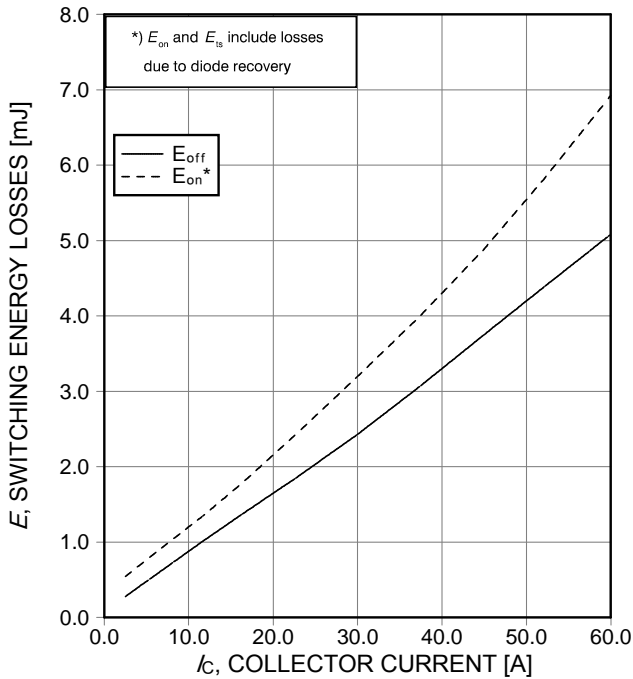

**Figure 13. Typical switching energy losses as a function of collector current**  
 (inductive load,  $T_j=175^\circ\text{C}$ ,  $V_{CE}=600\text{V}$ ,  $V_{GE}=15/0\text{V}$ ,  $R_G=16\Omega$ , Dynamic test circuit in Figure E)

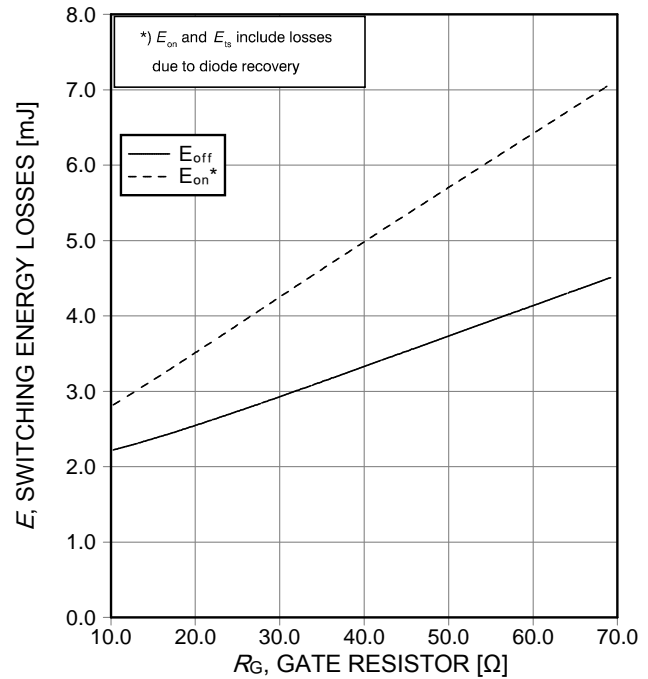

**Figure 14. Typical switching energy losses as a function of gate resistor**  
 (inductive load,  $T_j=175^\circ\text{C}$ ,  $V_{CE}=600\text{V}$ ,  $V_{GE}=15/0\text{V}$ ,  $I_C=30\text{A}$ , Dynamic test circuit in Figure E)

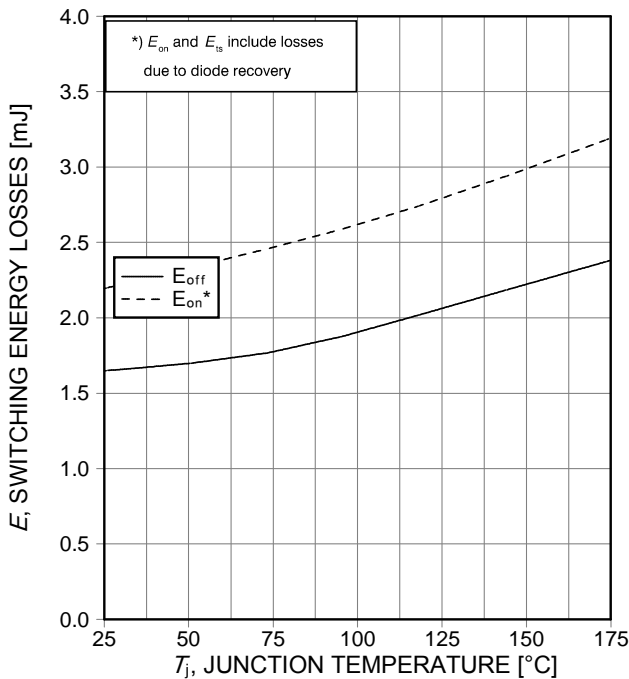

**Figure 15. Typical switching energy losses as a function of junction temperature**  
 (inductive load,  $V_{CE}=600\text{V}$ ,  $V_{GE}=15/0\text{V}$ ,  $I_C=30\text{A}$ ,  $R_G=16\Omega$ , Dynamic test circuit in Figure E)

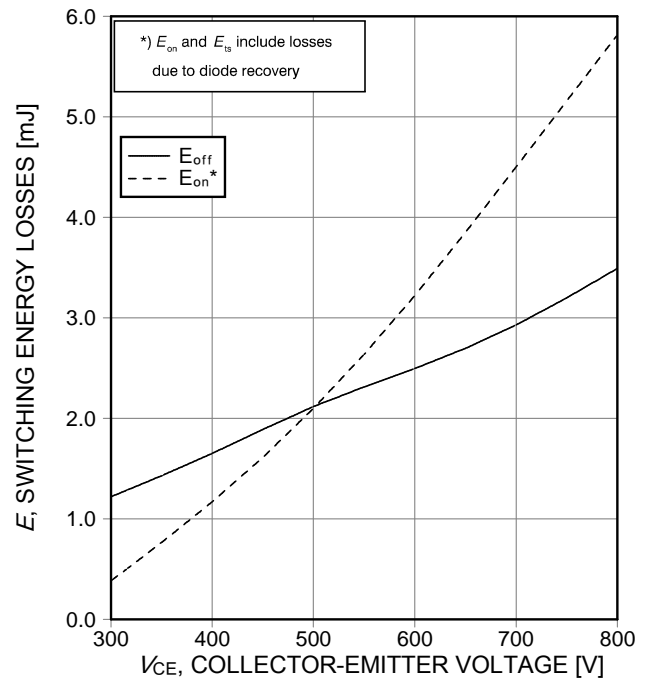

**Figure 16. Typical switching energy losses as a function of collector emitter voltage**  
 (inductive load,  $T_j=175^\circ\text{C}$ ,  $V_{GE}=15/0\text{V}$ ,  $I_C=30\text{A}$ ,  $R_G=16\Omega$ , Dynamic test circuit in Figure E)

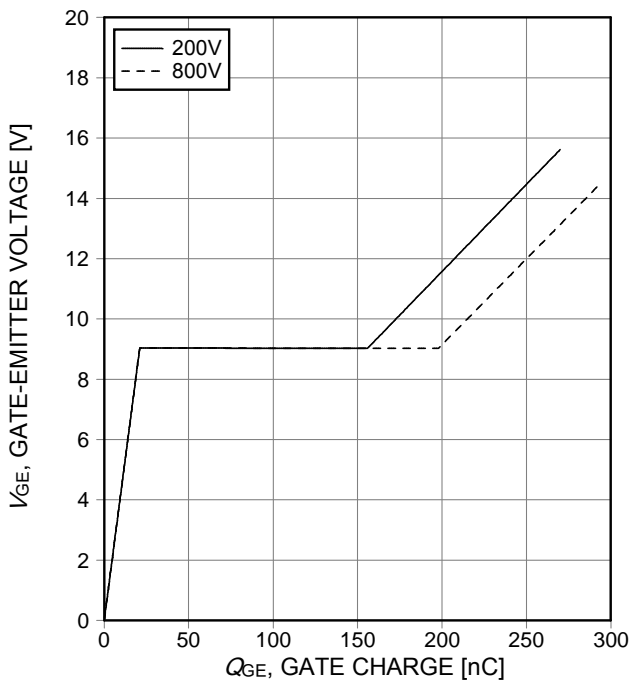

Figure 17. Typical gate charge  
( $I_C=30A$ )

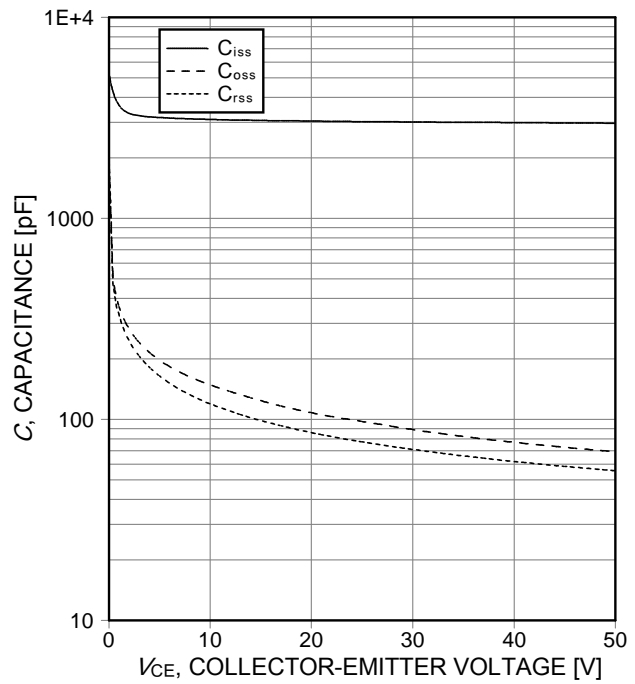

Figure 18. Typical capacitance as a function of collector-emitter voltage  
( $V_{GE}=0V$ ,  $f=1MHz$ )

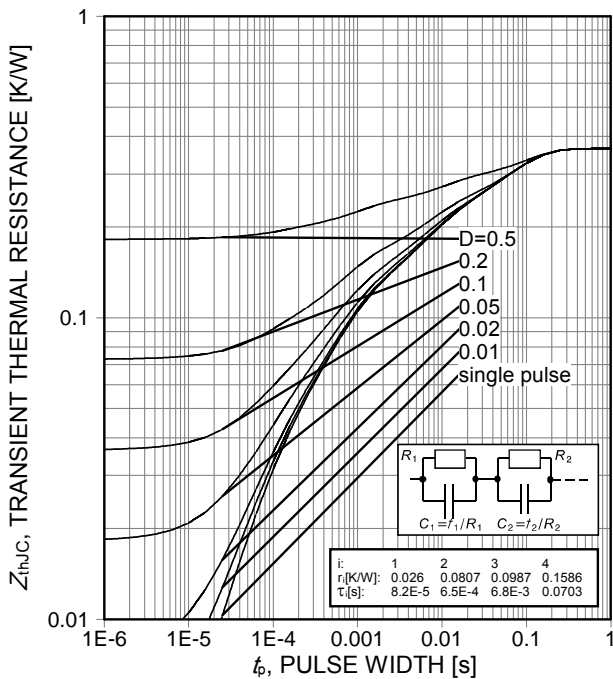
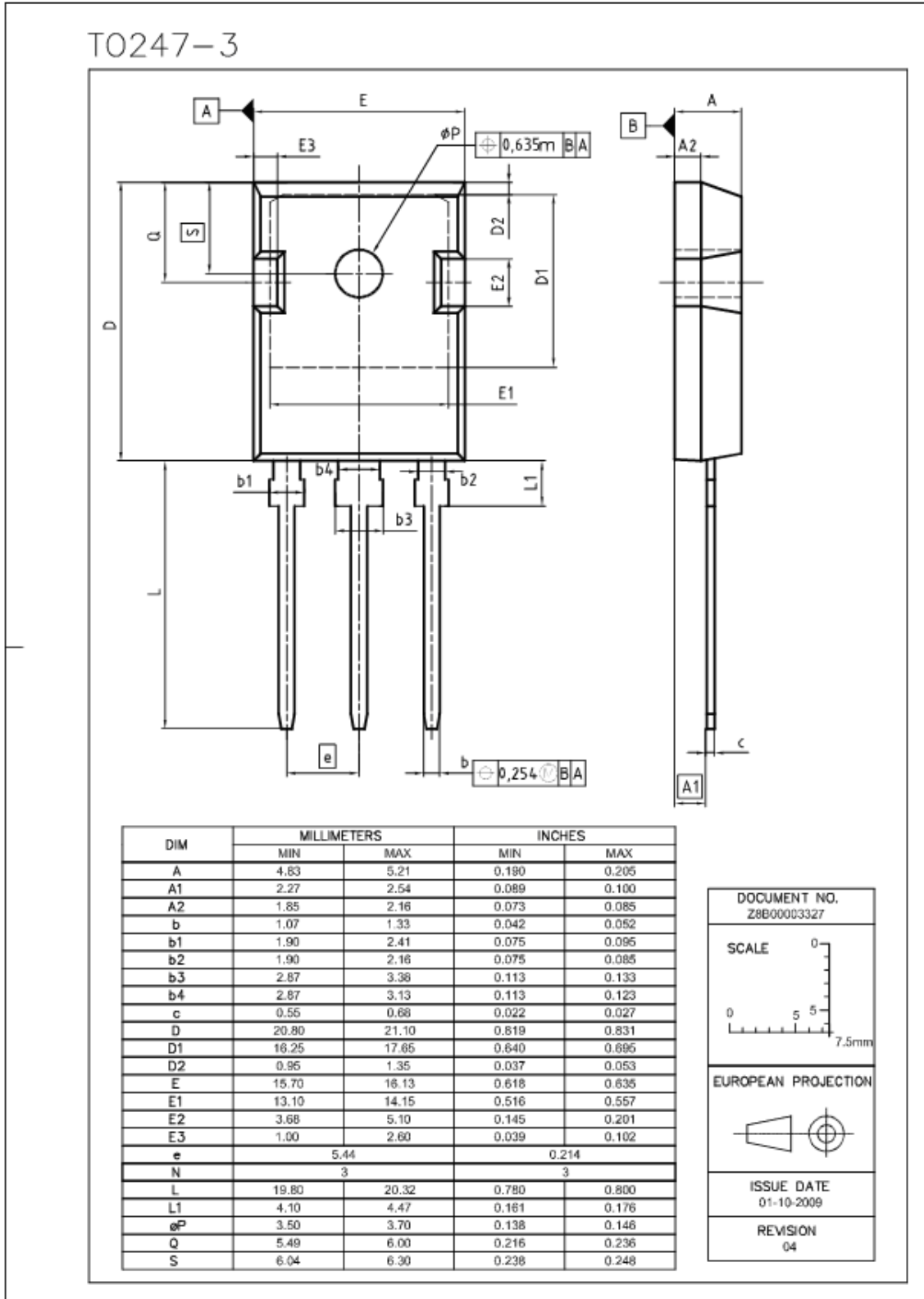

Figure 19. IGBT transient thermal resistance  
( $D=tp/T$ )



PG-TO247-3



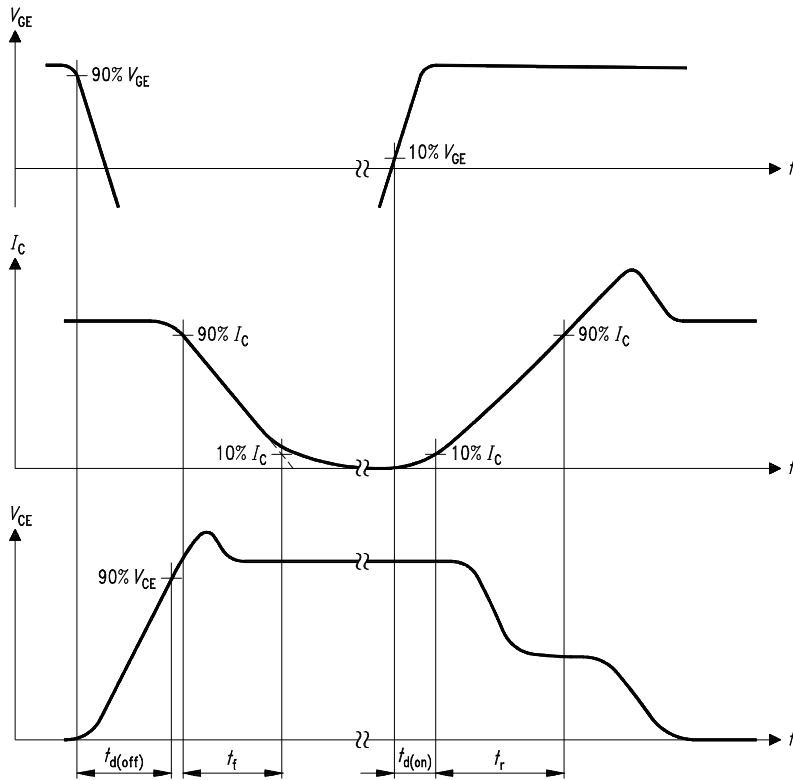

Figure A. Definition of switching times

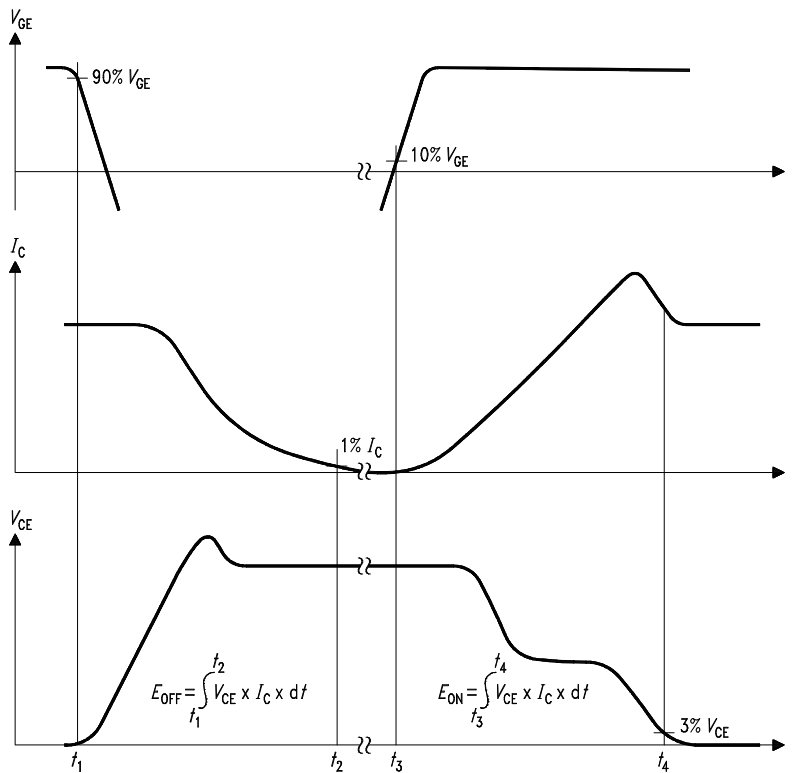

Figure B. Definition of switching losses

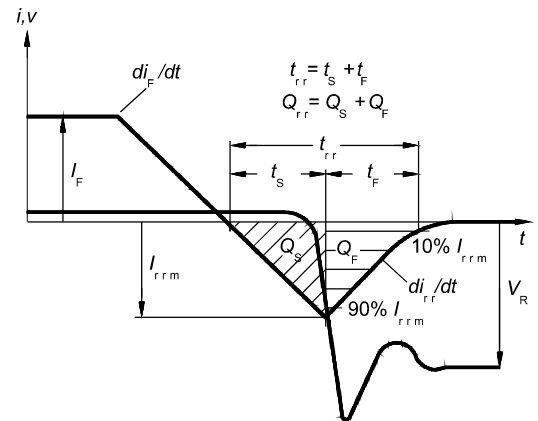

Figure C. Definition of diodes switching characteristics

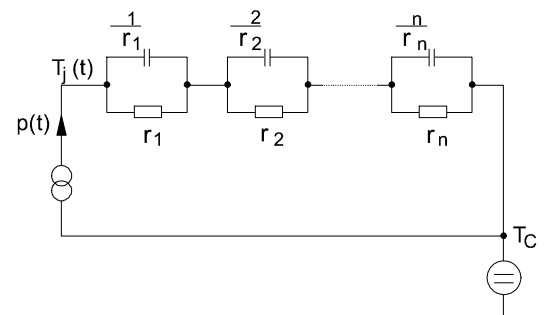

Figure D. Thermal equivalent circuit

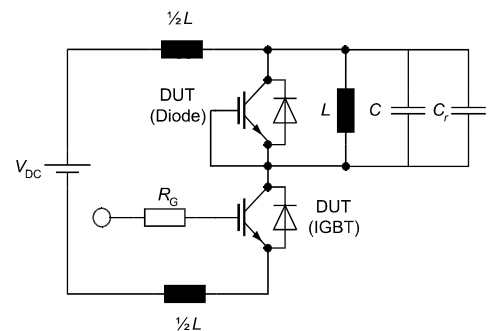

Figure E. Dynamic test circuit  
Leakage inductance  $L = 180\text{nH}$ ,  
Stray capacitor  $C_s = 40\text{pF}$ ,  
Relief capacitor  $C_r = 1\text{nF}$   
(only for ZVT switching)

**Published by**  
**Infineon Technologies AG**  
**81726 Munich, Germany**  
**81726 München, Germany**  
**© 2008 Infineon Technologies AG**  
**All Rights Reserved.**

**Legal Disclaimer**

The information given in this document shall in no event be regarded as a guarantee of conditions or characteristics. With respect to any examples or hints given herein, any typical values stated herein and/or any information regarding the application of the device, Infineon Technologies hereby disclaims any and all warranties and liabilities of any kind, including without limitation, warranties of non-infringement of intellectual property rights of any third party.

**Information**

For further information on technology, delivery terms and conditions and prices, please contact the nearest Infineon Technologies Office ([www.infineon.com](http://www.infineon.com)).

**Warnings**

Due to technical requirements, components may contain dangerous substances. For information on the types in question, please contact the nearest Infineon Technologies Office. Infineon Technologies components may be used in life-support devices or systems only with the express written approval of Infineon Technologies, if a failure of such components can reasonably be expected to cause the failure of that life-support device or system or to affect the safety or effectiveness of that device or system. Life support devices or systems are intended to be implanted in the human body or to support and/or maintain and sustain and/or protect human life. If they fail, it is reasonable to assume that the health of the user or other persons may be endangered.

# Mouser Electronics

Authorized Distributor

Click to View Pricing, Inventory, Delivery & Lifecycle Information:

[Infineon:](#)

[IGW30N100T](#)