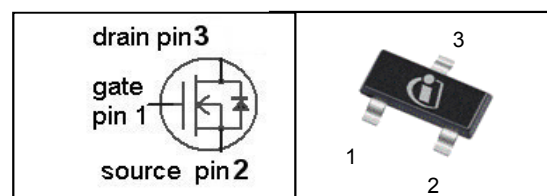

**OptiMOS™ Small-Signal-Transistor**
**Features**

- N-channel
- Enhancement mode
- Logic level
- Avalanche rated
- fast switching
- Pb-free lead-plating; RoHS compliant
- Halogen-free according to IEC61249-2-21

**Product Summary**

$V_{DS}$		60	V
$R_{DS(on),max}$	$V_{GS}=10\text{ V}$	3	$\Omega$
	$V_{GS}=4.5\text{ V}$	4	
$I_D$		0.3	A

**PG-SOT23**

Type	Package	Tape and Reel Information	Marking	HalogenFree	Packing
2N7002	PG-SOT-23	H6327: 3000 pcs/reel	72s	Yes	Non Dry

Parameter	Symbol	Conditions	Value	Unit
Continuous drain current	$I_D$	$T_A=25\text{ °C}$	0.30	A
		$T_A=70\text{ °C}$	0.24	
Pulsed drain current	$I_{D,pulse}$	$T_A=25\text{ °C}$	1.2	
Avalanche energy, single pulse	$E_{AS}$	$I_D=0.3\text{ A}, R_{GS}=25\ \Omega$	1.3	mJ
Reverse diode $dv/dt$	$dv/dt$	$I_D=0.3\text{ A}, V_{DS}=48\text{ V},$ $di/dt=200\text{ A}/\mu\text{s},$ $T_{j,max}=150\text{ °C}$	6	kV/ $\mu\text{s}$
Gate source voltage	$V_{GS}$		$\pm 20$	V
ESD class		JESD22-A114 (HBM)	class 0 (<250V)	
Power dissipation	$P_{tot}^{(2)}$	$T_A=25\text{ °C}$	0.5	W
Operating and storage temperature	$T_j, T_{stg}$		-55 ... 150	$^{\circ}\text{C}$
IEC climatic category; DIN IEC 68-1			55/150/56	

<sup>(1)</sup> J-STD20 and JESD22

Parameter	Symbol	Conditions	Values			Unit
			min.	typ.	max.	

**Thermal characteristics**

Thermal resistance, junction - minimal footprint <sup>(2)</sup>	$R_{thJA}$		-	-	250	K/W
---	------------	--	---	---	-----	-----

**Electrical characteristics, at  $T_j=25\text{ }^\circ\text{C}$ , unless otherwise specified**
**Static characteristics**

Drain-source breakdown voltage	$V_{(BR)DSS}$	$V_{GS}=0\text{ V}, I_D=250\text{ }\mu\text{A}$	60	-	-	V
Gate threshold voltage	$V_{GS(th)}$	$V_{DS}=V_{GS}, I_D=250\text{ }\mu\text{A}$	1.5	2.1	2.5	
Drain-source leakage current	$I_{D(off)}$	$V_{DS}=60\text{ V},$ $V_{GS}=0\text{ V}, T_j=25\text{ }^\circ\text{C}$	-	-	0.1	$\mu\text{A}$
		$V_{DS}=60\text{ V},$ $V_{GS}=0\text{ V}, T_j=150\text{ }^\circ\text{C}$	-	-	5	
Gate-source leakage current	$I_{GSS}$	$V_{GS}=20\text{ V}, V_{DS}=0\text{ V}$	-	1	10	nA
Drain-source on-state resistance	$R_{DS(on)}$	$V_{GS}=4.5\text{ V}, I_D=0.25\text{ A}$	-	2.0	4	$\Omega$
		$V_{GS}=10\text{ V}, I_D=0.5\text{ A}$	-	1.6	3	
Transconductance	$g_{fs}$	$ V_{DS} >2 I_D R_{DS(on)max},$ $I_D=0.24\text{ A}$	0.2	0.36	-	S

<sup>(2)</sup> Performed on a 40x40mm<sup>2</sup> FR4 PCB with both sided Cu sense-force traces, each 1mm wide, 70  $\mu\text{m}$  thick and 20mm long.

Parameter	Symbol	Conditions	Values			Unit
			min.	typ.	max.	

**Dynamic characteristics**

Input capacitance	$C_{iss}$	$V_{GS}=0\text{ V}, V_{DS}=25\text{ V},$ $f=1\text{ MHz}$	-	13	20	pF
Output capacitance	$C_{oss}$		-	4.1	6	
Reverse transfer capacitance	$C_{rss}$		-	2.0	3	
Turn-on delay time	$t_{d(on)}$	$V_{DD}=30\text{ V}, V_{GS}=10\text{ V},$ $I_D=0.5\text{ A}, R_G=6\ \Omega$	-	3.0	4.5	ns
Rise time	$t_r$		-	3.3	5	
Turn-off delay time	$t_{d(off)}$		-	5.5	9	
Fall time	$t_f$		-	3.1	5	

**Gate Charge Characteristics**

Gate to source charge	$Q_{gs}$	$V_{DD}=48\text{ V}, I_D=0.5\text{ A},$ $V_{GS}=0\text{ to }10\text{ V}$	-	0.05	0.1	nC
Gate to drain charge	$Q_{gd}$		-	0.2	0.4	
Gate charge total	$Q_g$		-	0.4	0.6	
Gate plateau voltage	$V_{plateau}$		-	4.0	-	V

**Reverse Diode**

Diode continuous forward current	$I_S$	$T_A=25\text{ }^\circ\text{C}$	-	-	0.3	A
Diode pulse current	$I_{S,pulse}$		-	-	1.2	
Diode forward voltage	$V_{SD}$	$V_{GS}=0\text{ V}, I_F=0.5\text{ A},$ $T_J=25\text{ }^\circ\text{C}$	-	0.96	1.2	V
Reverse recovery time	$t_{rr}$	$V_R=30\text{ V}, I_F=0.5\text{ A},$ $di_F/dt=100\text{ A}/\mu\text{s}$	-	8.5	13	ns
Reverse recovery charge	$Q_{rr}$		-	2.4	4	nC

**1 Power dissipation**

$P_{tot}=f(T_A)$

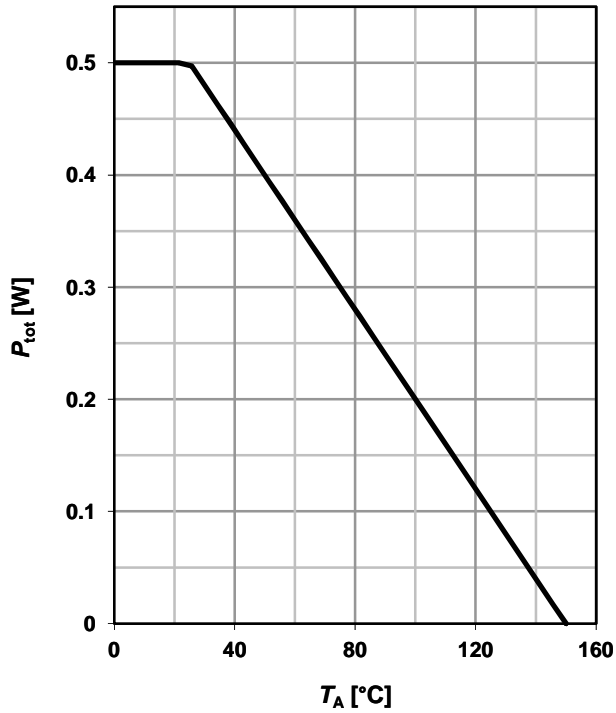

**2 Drain current**

$I_D=f(T_A); V_{GS} \geq 10\text{ V}$

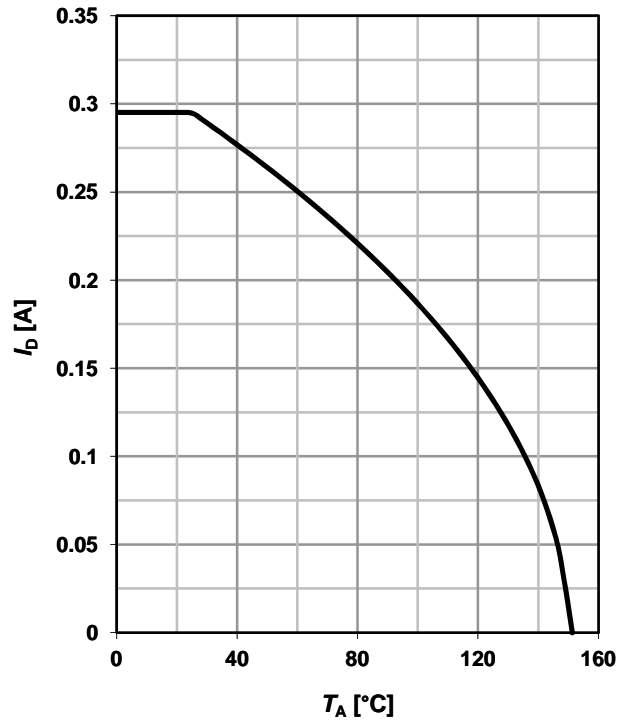

**3 Safe operating area**

$I_D=f(V_{DS}); T_A=25\text{ °C}; D=0$

parameter:  $t_p$

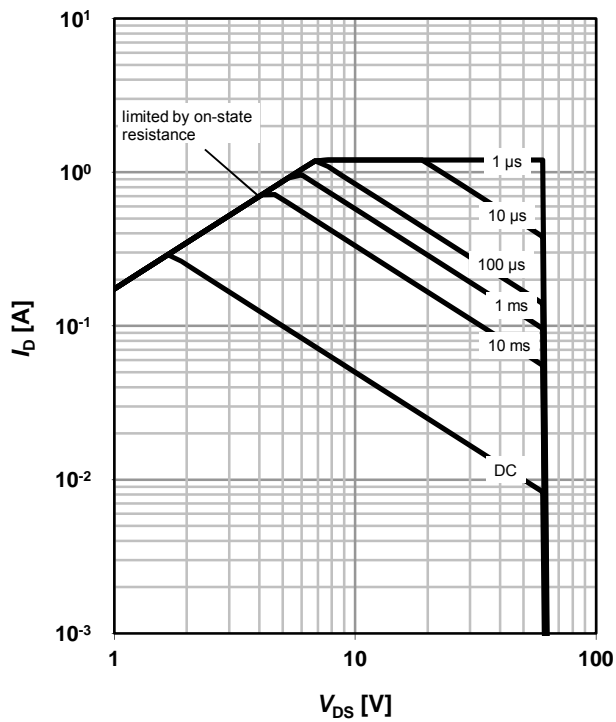

**4 Max. transient thermal impedance**

$Z_{thJA}=f(t_p)$

parameter:  $D=t_p/T$

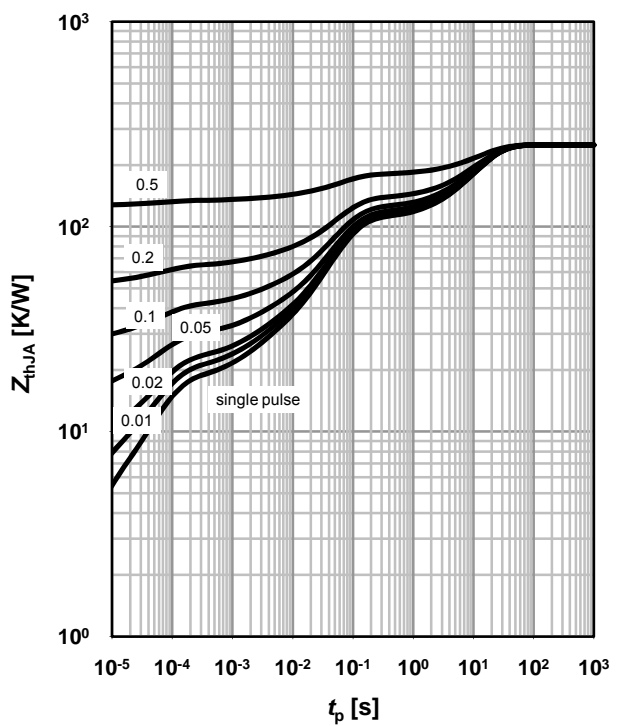

**5 Typ. output characteristics**

$I_D = f(V_{DS}); T_j = 25\text{ }^\circ\text{C}$

parameter:  $V_{GS}$

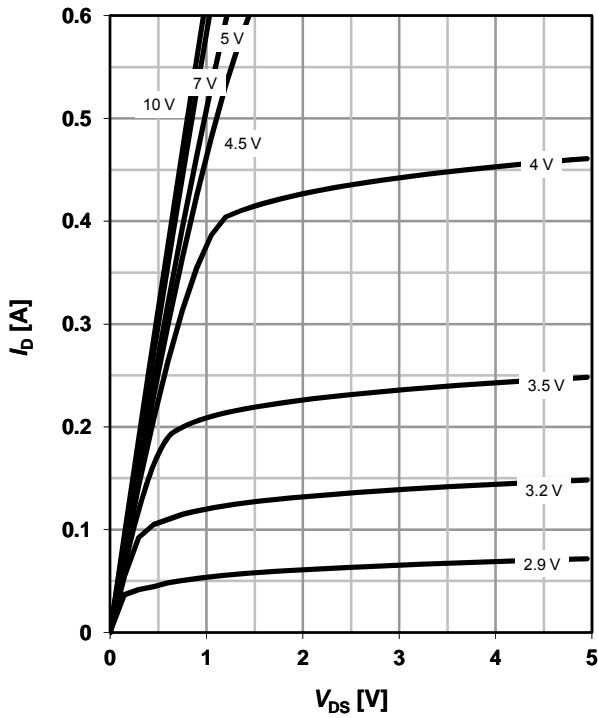

**6 Typ. drain-source on resistance**

$R_{DS(on)} = f(I_D); T_j = 25\text{ }^\circ\text{C}$

parameter:  $V_{GS}$

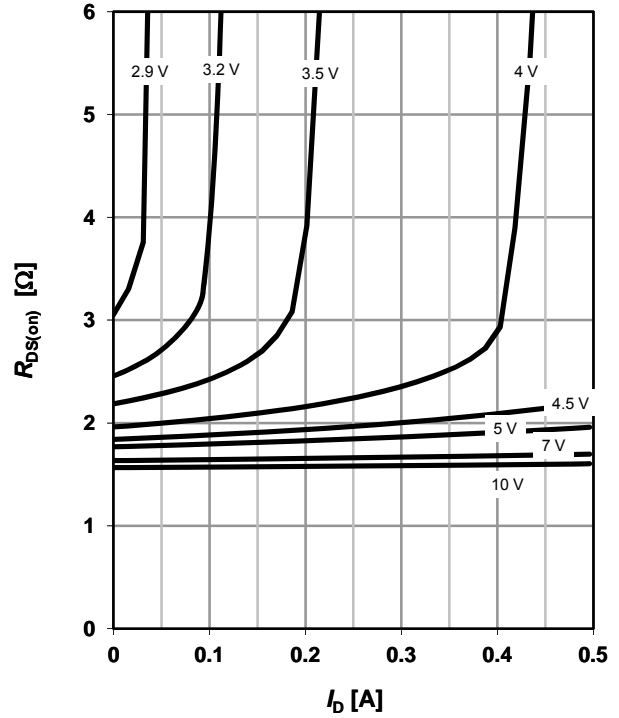

**7 Typ. transfer characteristics**

$I_D = f(V_{GS}); |V_{DS}| > 2|I_D|R_{DS(on)max}$

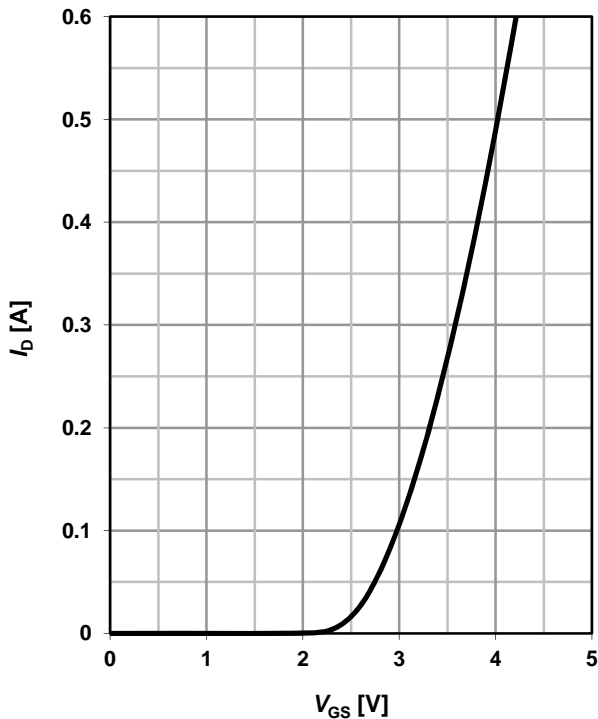

**8 Typ. forward transconductance**

$g_{fs} = f(I_D); T_j = 25\text{ }^\circ\text{C}$

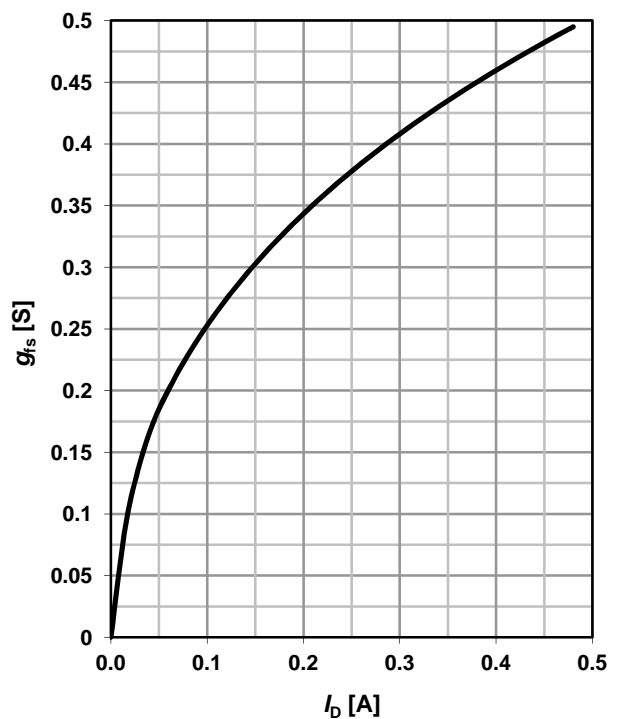

**9 Drain-source on-state resistance**

$R_{DS(on)}=f(T_j); I_D=0.3\text{ A}; V_{GS}=10\text{ V}$

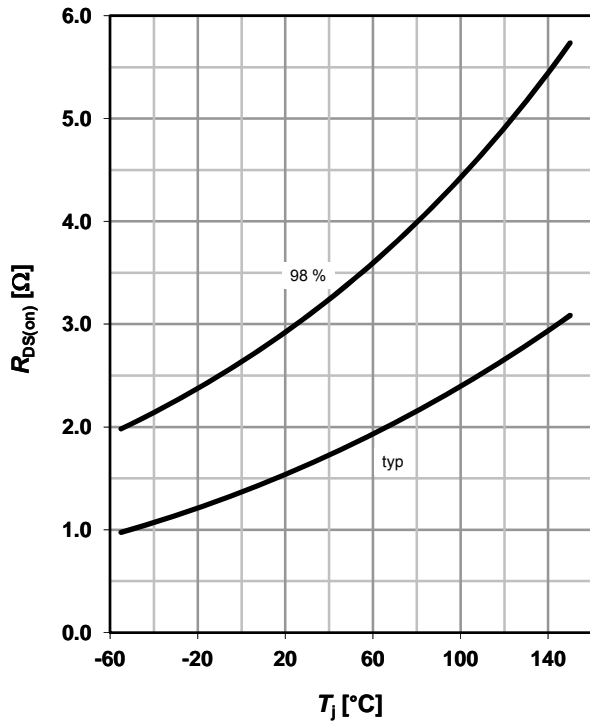

**10 Typ. gate threshold voltage**

$V_{GS(th)}=f(T_j); V_{DS}=V_{GS}; I_D=250\ \mu\text{A}$

parameter:  $I_D$

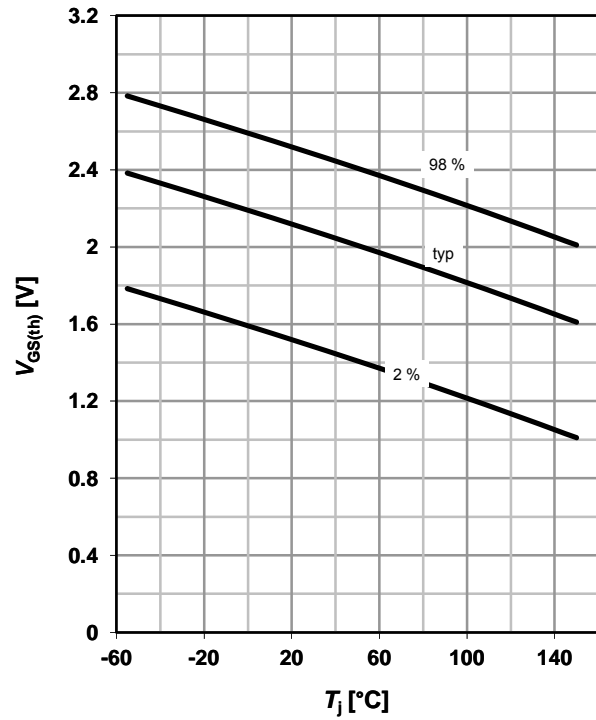

**11 Typ. capacitances**

$C=f(V_{DS}); V_{GS}=0\text{ V}; f=1\text{ MHz}; T_j=25^\circ\text{C}$

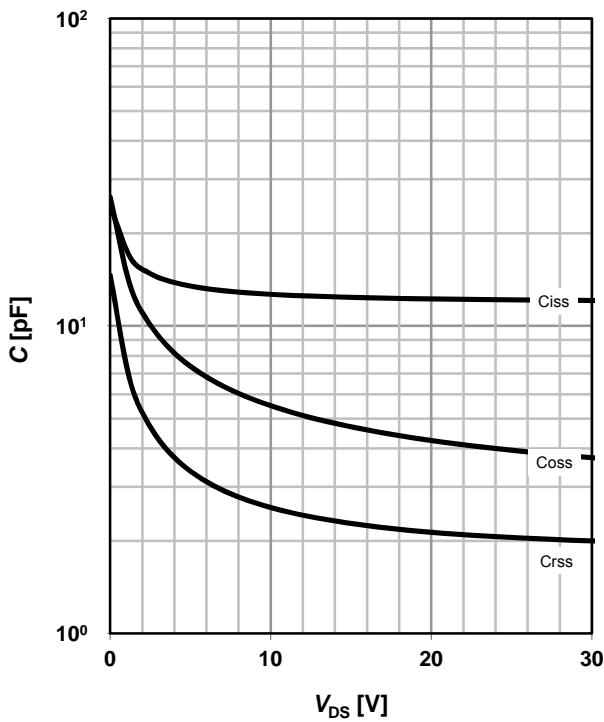

**12 Forward characteristics of reverse diode**

$I_F=f(V_{SD})$

parameter:  $T_j$

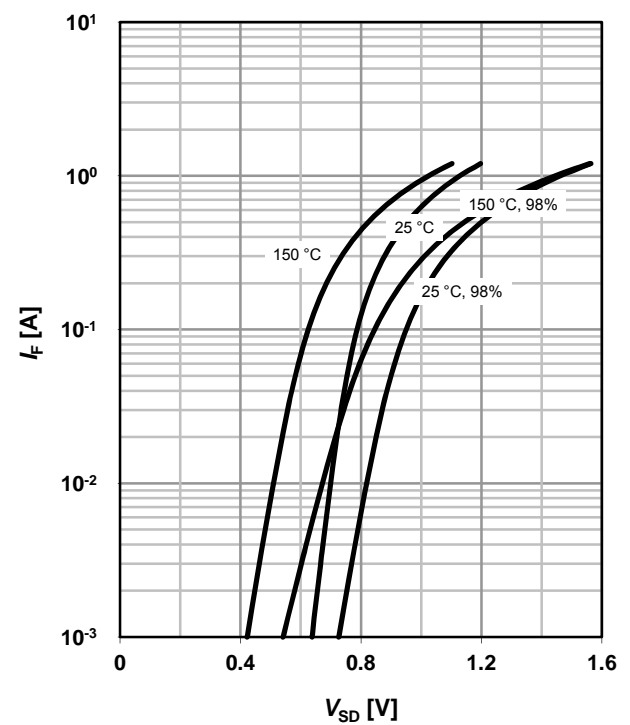

**13 Avalanche characteristics**

$I_{AS}=f(t_{AV}); R_{GS}=25\Omega$

parameter:  $T_{j(\text{start})}$

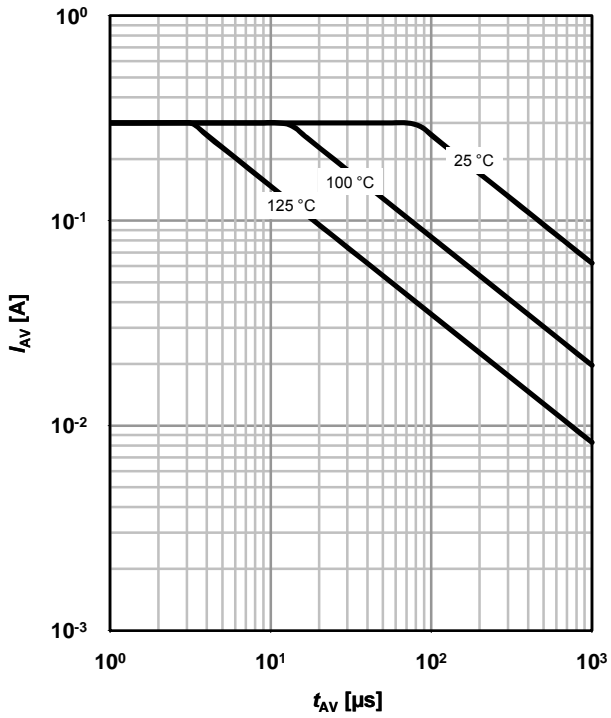

**14 Typ. gate charge**

$V_{GS}=f(Q_{\text{gate}}); I_D=0.5\text{ A pulsed}$

parameter:  $V_{DD}$

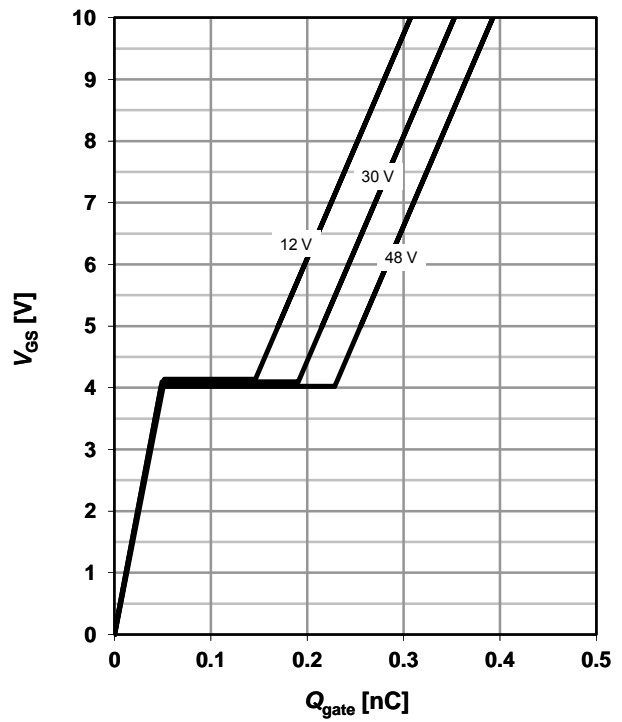

**15 Drain-source breakdown voltage**

$V_{BR(DSS)}=f(T_j); I_D=250\ \mu\text{A}$

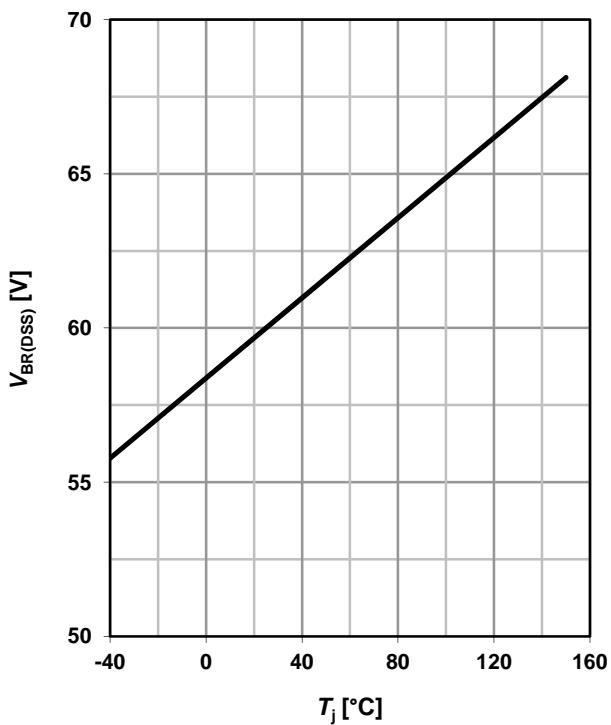

Package Outline:

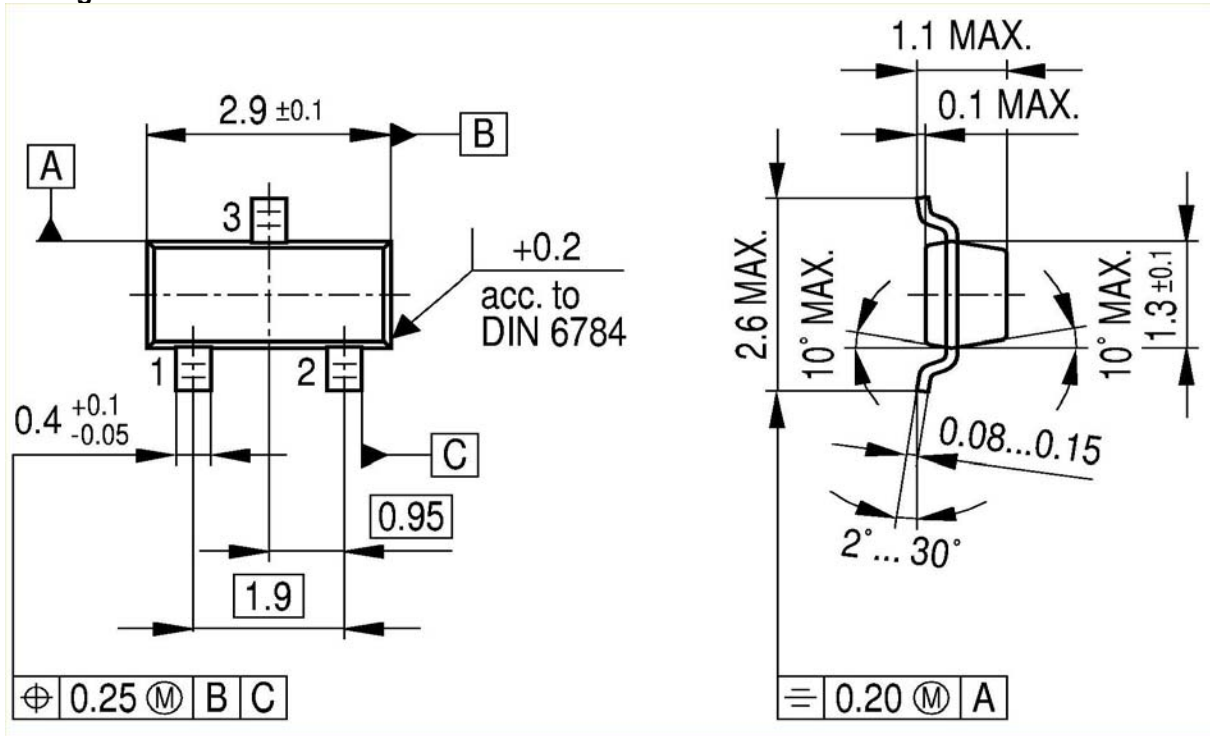

Footprint:

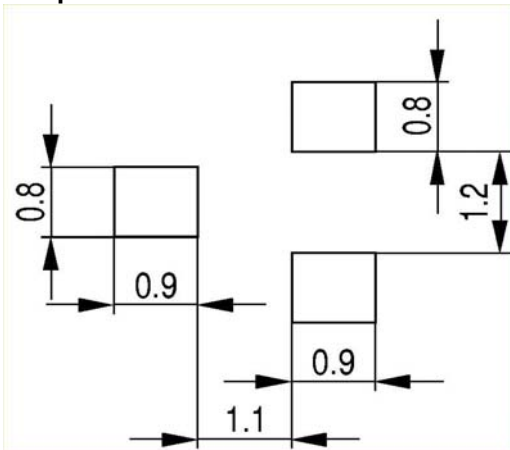

Packing:

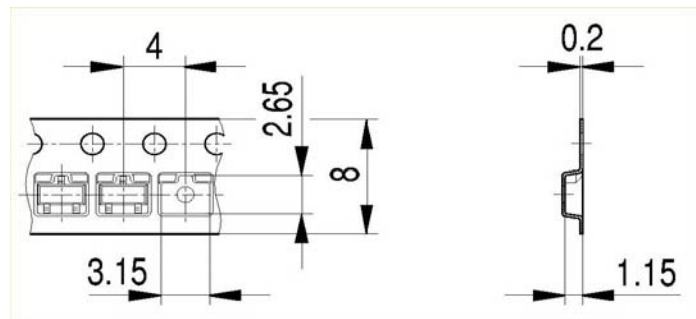

Dimensions in mm



**Published by**  
**Infineon Technologies AG**  
**81726 Munich, Germany**  
**© 2008 Infineon Technologies AG**  
**All Rights Reserved.**

#### **Legal Disclaimer**

The information given in this document shall in no event be regarded as a guarantee of conditions or characteristics. With respect to any examples or hints given herein, any typical values stated herein and/or any information regarding the application of the device, Infineon Technologies hereby disclaims any and all warranties and liabilities of any kind, including without limitation, warranties of non-infringement of intellectual property rights of any third party.

#### **Information**

For further information on technology, delivery terms and conditions and prices, please contact the nearest Infineon Technologies Office ([www.infineon.com](http://www.infineon.com)).

#### **Warnings**

Due to technical requirements, components may contain dangerous substances. For information on the types in question, please contact the nearest Infineon Technologies Office.

Infineon Technologies components may be used in life-support devices or systems only with the express written approval of Infineon Technologies, if a failure of such components can reasonably be expected to cause the failure of that life-support device or system or to affect the safety or effectiveness of that device or system. Life support devices or systems are intended to be implanted in the human body or to support and/or maintain and sustain and/or protect human life. If they fail, it is reasonable to assume that the health of the user or other persons may be endangered.

# Mouser Electronics

Authorized Distributor

Click to View Pricing, Inventory, Delivery & Lifecycle Information:

[Infineon:](#)

[2N7002H6327XTSA2](#)