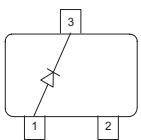
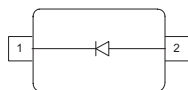
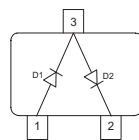
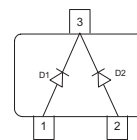
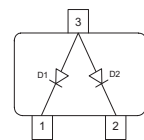

Silicon Schottky Diodes

- For low-loss, fast-recovery, meter protection, bias isolation and clamping application
- Integrated diffused guard ring
- Low forward voltage
- Pb-free (RoHS compliant) package
- Qualified according AEC Q101

BAT64

**BAT64-02W
BAT64-02V**

**BAT64-04
BAT64-04W**

**BAT64-05
BAT64-05W**

**BAT64-06
BAT64-06W**

ESD (Electrostatic discharge) sensitive device, observe handling precaution!

Type	Package	Configuration	L_S (nH)	Marking
BAT64	SOT23	single	1.8	63s
BAT64-02V	SC79	single	0.6	t
BAT64-02W*	SCD80	single	0.6	64
BAT64-04	SOT23	series	1.8	64s
BAT64-04W	SOT323	series	1.4	64s
BAT64-05	SOT23	common cathode	1.8	65s
BAT64-05W	SOT323	common cathode	1.4	65s
BAT64-06	SOT23	common anode	1.8	66s
BAT64-06W	SOT323	common anode	1.4	66s

* Not for new design

Maximum Ratings at $T_A = 25\text{ °C}$, unless otherwise specified

Parameter	Symbol	Value	Unit
Diode reverse voltage	V_R	40	V
Forward current	I_F	250	mA
Non-repetitive peak surge forward current ($t \leq 10\text{ms}$)	I_{FSM}	800	
Average rectified forward current (50/60Hz, sinus)	I_{FAV}	120	
Total power dissipation	P_{tot}		mW
BAT64, $T_S \leq 86\text{°C}$		250	
BAT64-02W, -02V $T_S \leq 121\text{°C}$		250	
BAT64-04, BAT64-06, $T_S \leq 61\text{°C}$		250	
BAT64-04W, BAT64-06W, $T_S \leq 111\text{°C}$		250	
BAT64-05, $T_S \leq 36\text{°C}$		250	
BAT64-05W, $T_S \leq 104\text{°C}$		250	
Junction temperature	T_j	150	°C
Storage temperature	T_{stg}	-55 ... 150	

Thermal Resistance

Parameter	Symbol	Value	Unit
Junction - soldering point ¹⁾	R_{thJS}		K/W
BAT64		≤ 255	
BAT64-02W, -02V		≤ 115	
BAT64-04, BAT64-06,		≤ 355	
BAT64-04W, BAT64-06W		≤ 155	
BAT64-05		≤ 455	
BAT64-05W		≤ 185	

¹⁾For calculation of R_{thJA} please refer to Application Note AN077 (Thermal Resistance Calculation)

Electrical Characteristics at $T_A = 25\text{ °C}$, unless otherwise specified

Parameter	Symbol	Values			Unit
		min.	typ.	max.	
DC Characteristics					
Breakdown voltage $I_{(BR)} = 10\text{ }\mu\text{A}$	$V_{(BR)}$	40	-	-	V
Reverse current $V_R = 30\text{ V}$ $V_R = 30\text{ V}, T_A = 85\text{ °C}$	I_R	- -	- -	2 200	μA
Forward voltage $I_F = 1\text{ mA}$ $I_F = 10\text{ mA}$ $I_F = 30\text{ mA}$ $I_F = 100\text{ mA}$	V_F	270 310 370 500	320 385 440 570	350 430 520 750	mV
AC Characteristics					
Diode capacitance $V_R = 1\text{ V}, f = 1\text{ MHz}$	C_T	-	4	6	pF
Reverse recovery time $I_F = 10\text{ mA}, I_R = 10\text{ mA}, \text{measured } I_R = 1\text{ mA},$ $R_L = 100\text{ }\Omega$	t_{rr}	-	-	5	ns

Diode capacitance $C_T = f(V_R)$

$f = 1\text{MHz}$

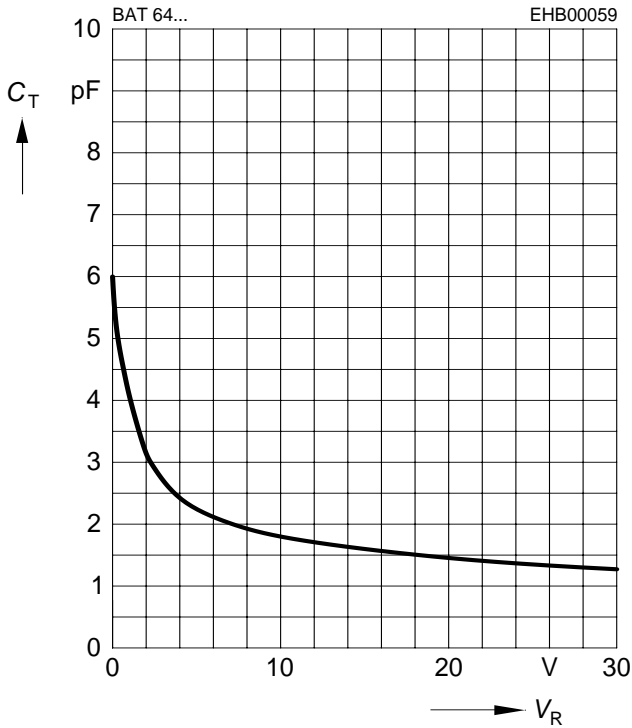

Reverse current $I_R = f(V_R)$

$T_A = \text{Parameter}$

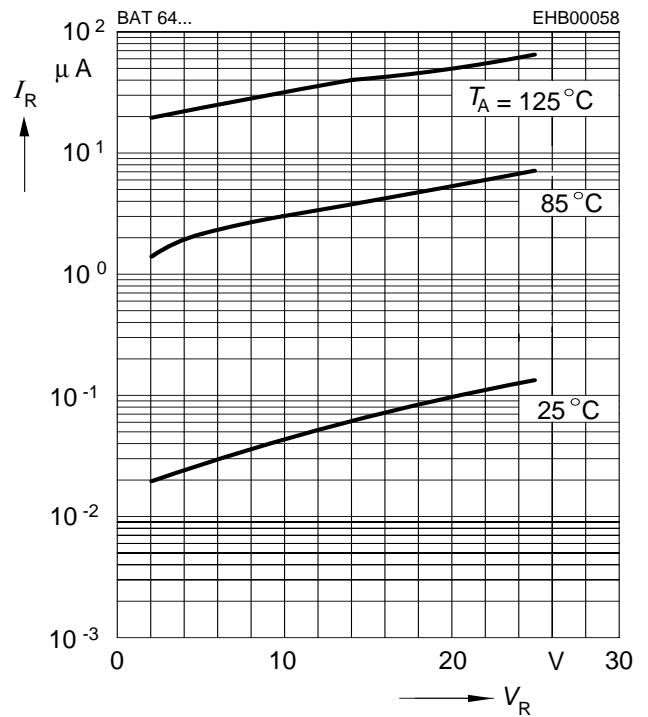

Forward current $I_F = f(V_F)$

$T_A = \text{Parameter}$

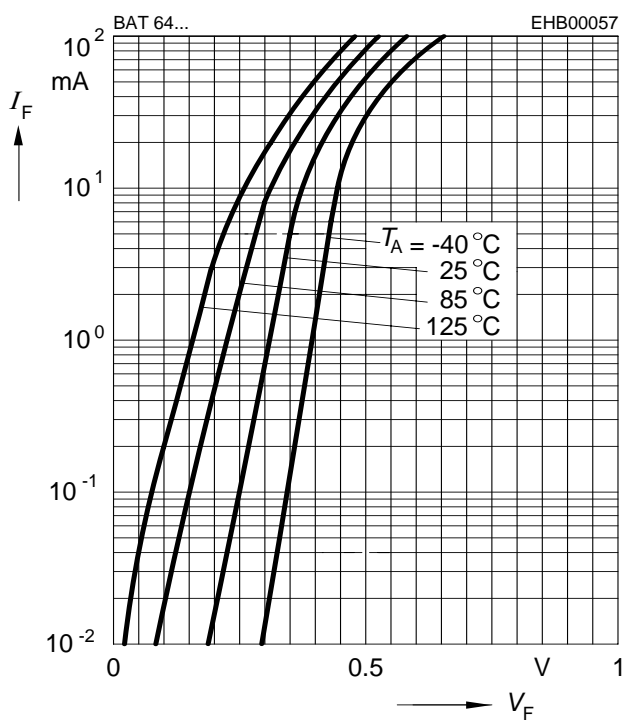

Forward current $I_F = f(T_S)$

BAT64

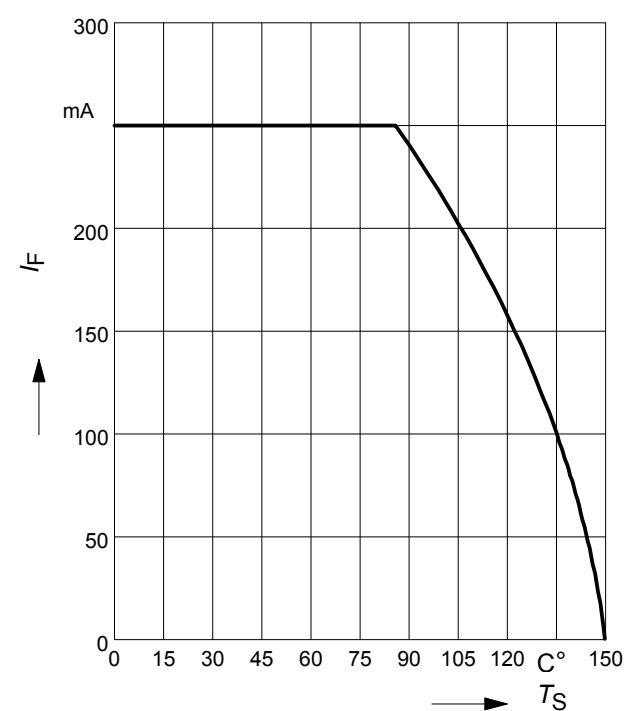

Forward current $I_F = f(T_S)$

BAT64-02W, -02V

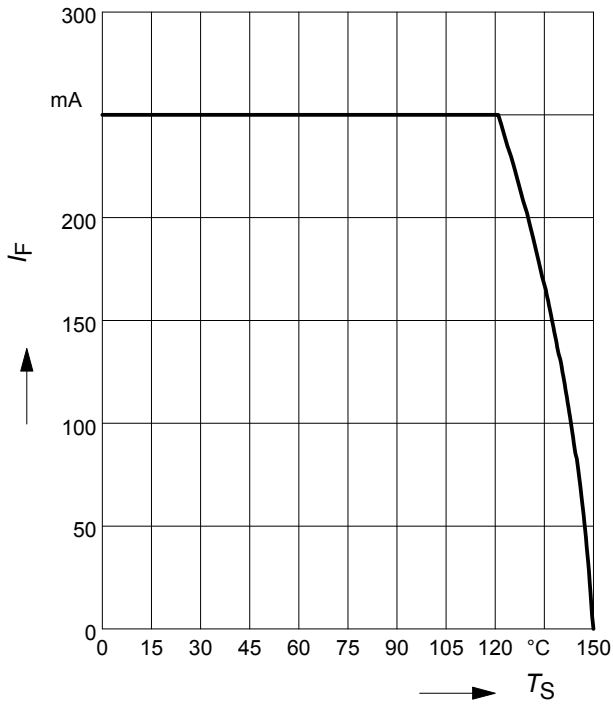

Forward current $I_F = f(T_S)$

BAT64-04, BAT64-06

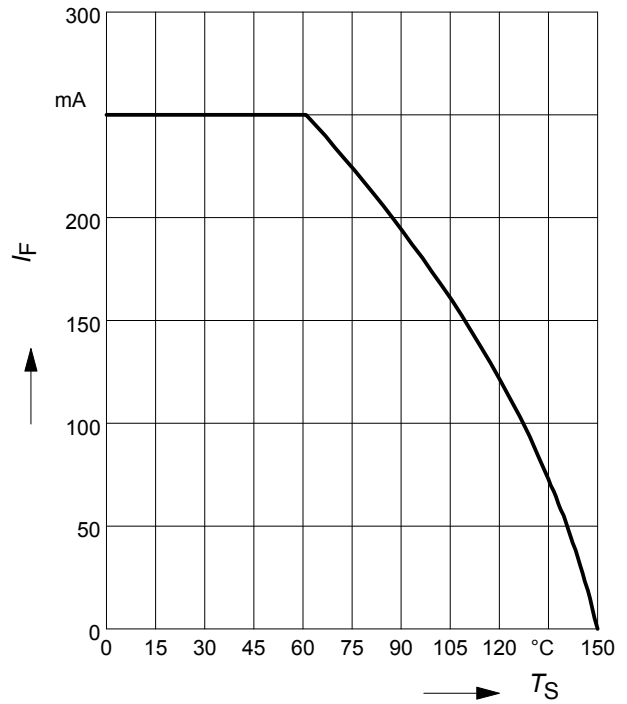

Forward current $I_F = f(T_S)$

BAT64-04W, BAT64-06W

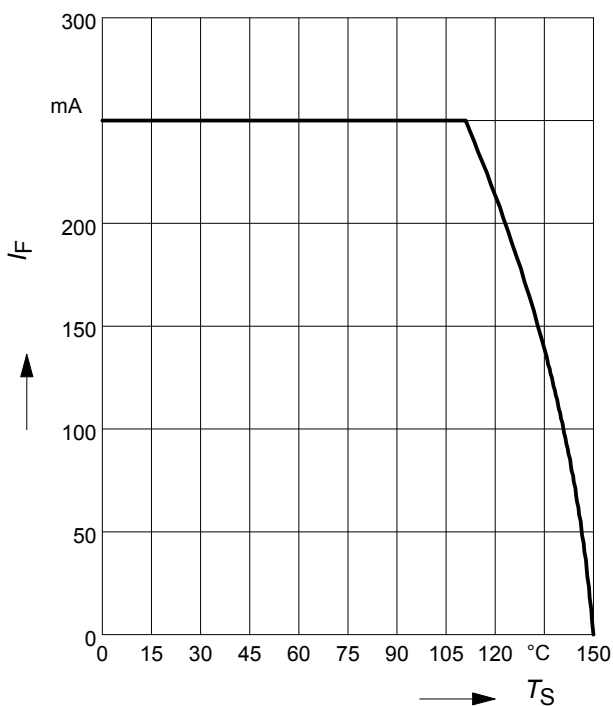

Forward current $I_F = f(T_S)$

BAT64-05

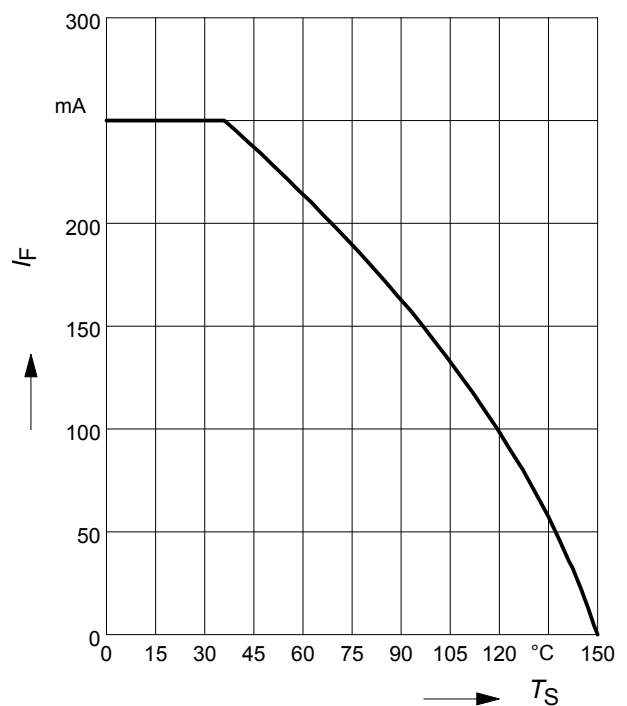

Forward current $I_F = f(T_S)$

BAT64-05W

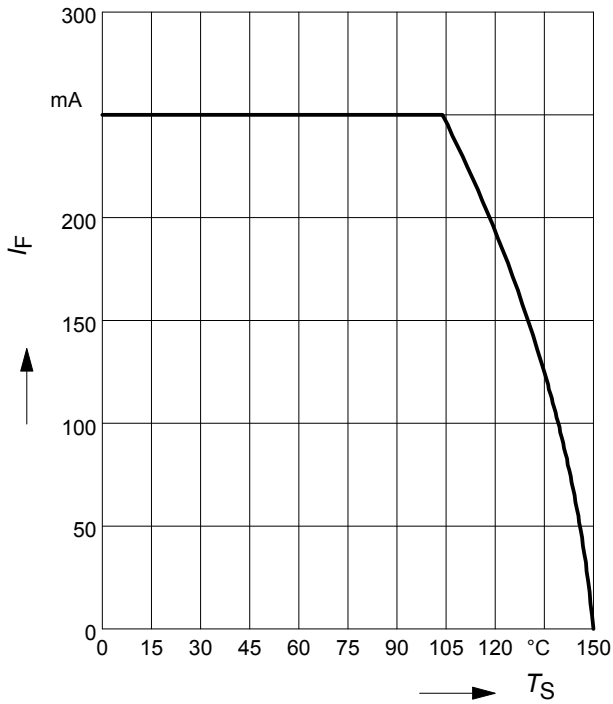

Permissible Puls Load $R_{thJS} = f(t_p)$

BAT64-02W, -02V

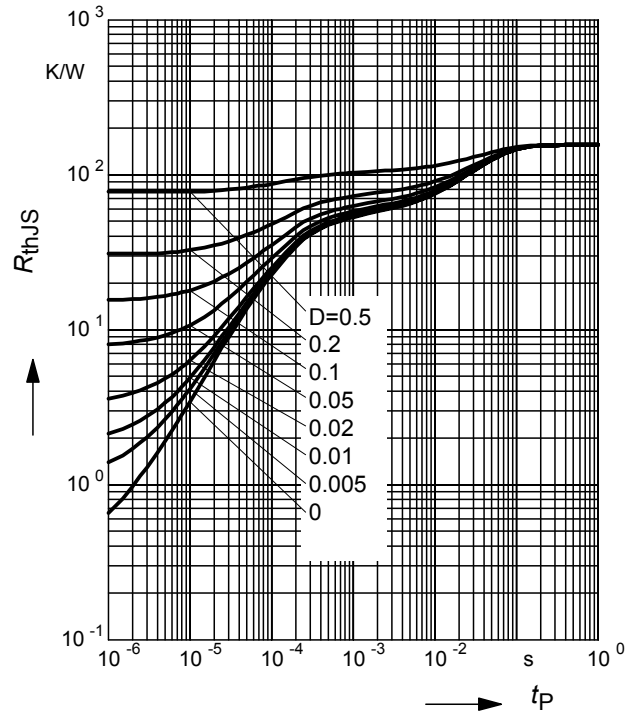

Permissible Pulse Load

$I_{Fmax} / I_{FDC} = f(t_p)$

BAT64-02W, -02V

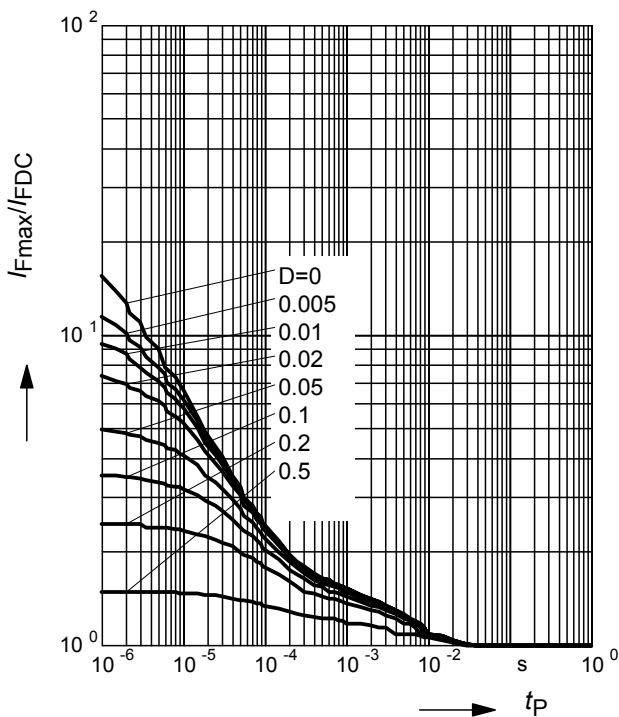

Permissible Puls Load $R_{thJS} = f(t_p)$

BAT64-04W, BAT64-06W

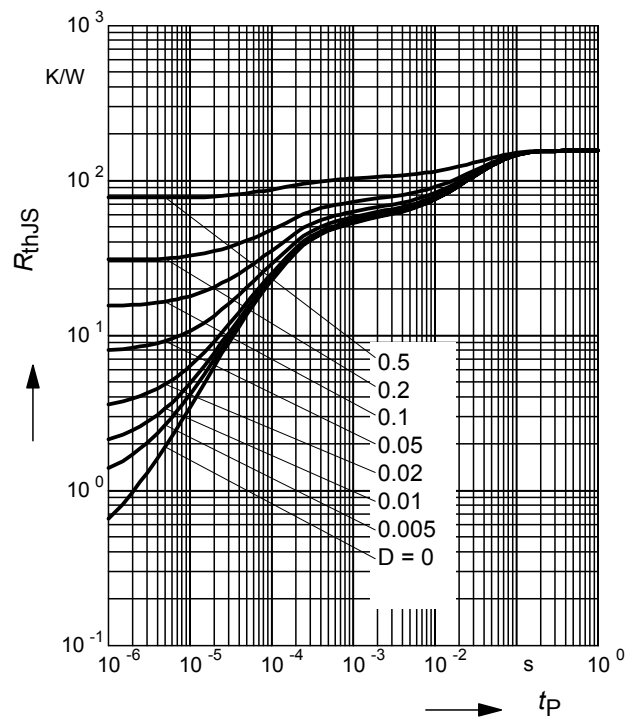

Permissible Pulse Load

$$I_{Fmax} / I_{FDC} = f(t_p)$$

BAT64-04W, BAT64-06W

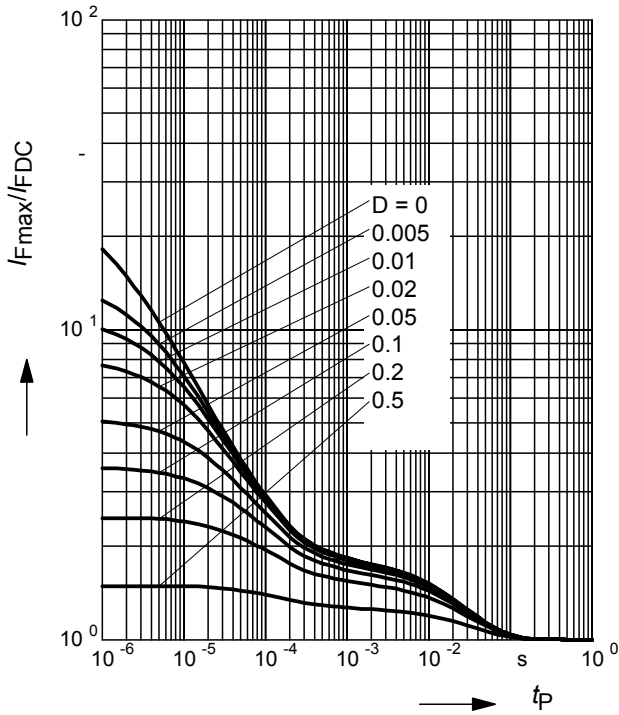

Permissible Puls Load $R_{thJS} = f(t_p)$

BAT64-05W

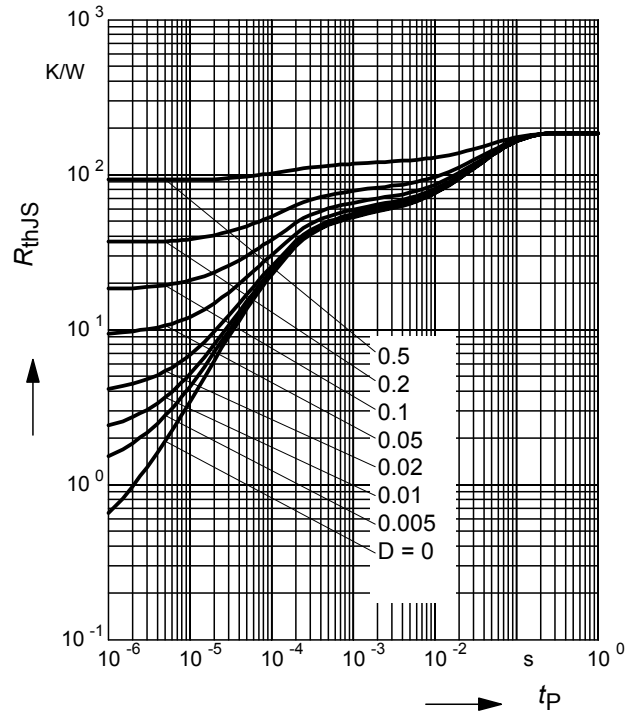

Permissible Pulse Load

$$I_{Fmax} / I_{FDC} = f(t_p)$$

BAT64-05W

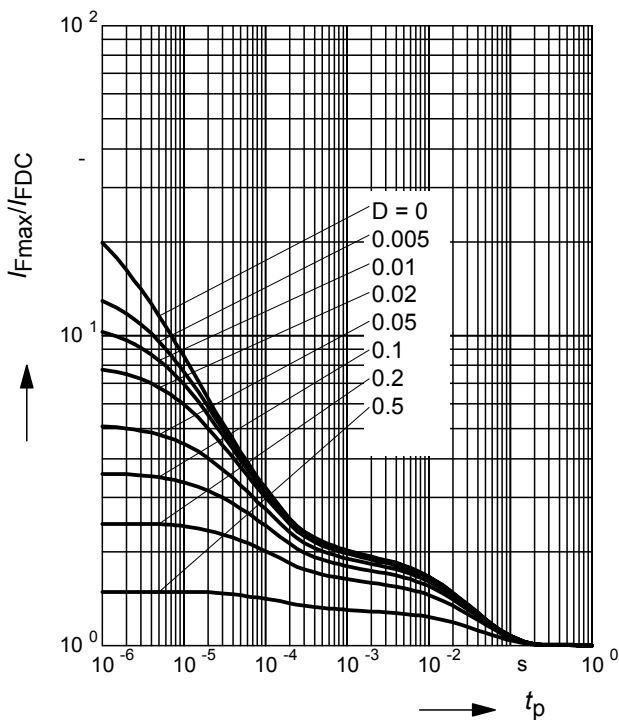

Package Outline



Foot Print

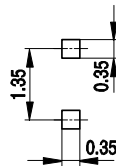

Marking Layout (Example)

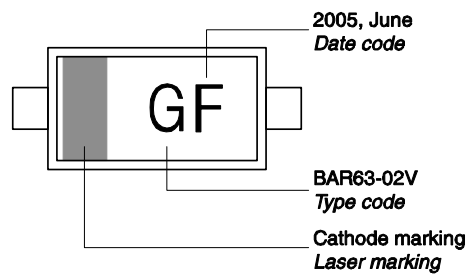

Standard Packing

- Reel \varnothing 180 mm = 3.000 Pieces/Reel
- Reel \varnothing 180 mm = 8.000 Pieces/Reel (2 mm Pitch)
- Reel \varnothing 330 mm = 10.000 Pieces/Reel

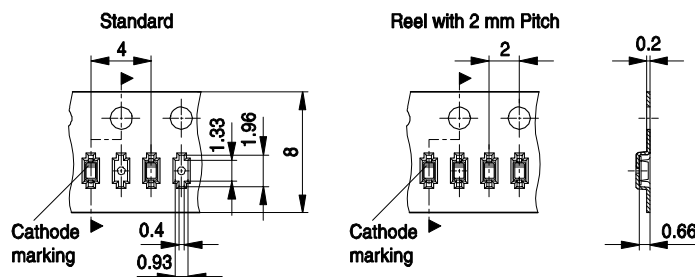

Package Outline

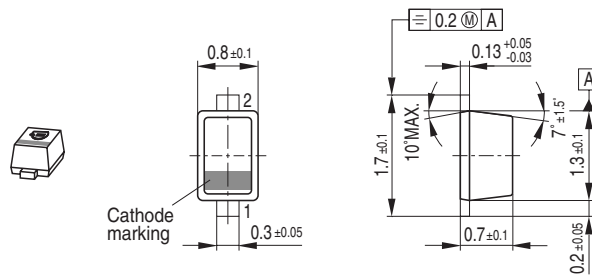

Foot Print

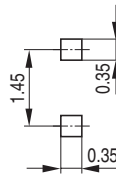

Marking Layout (Example)

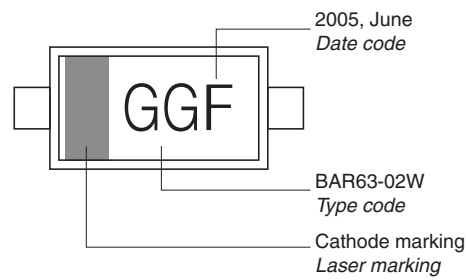

Standard Packing

Reel \varnothing 180 mm = 3.000 Pieces/Reel
 Reel \varnothing 180 mm = 8.000 Pieces/Reel (2 mm Pitch)
 Reel \varnothing 330 mm = 10.000 Pieces/Reel

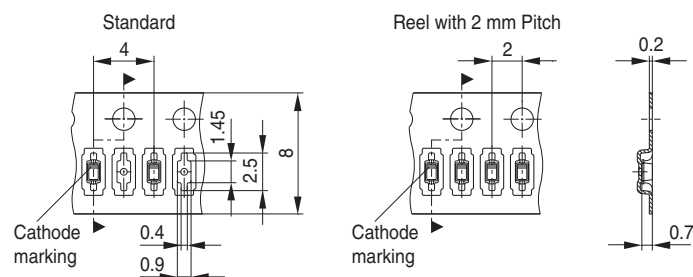

Date Code marking for discrete packages with one digit (SCD80, SC79, SC75¹⁾) CES-Code

Month	2003	2004	2005	2006	2007	2008	2009	2010	2011	2012	2013	2014
01	a	p	A	P	a	p	A	P	a	p	A	P
02	b	q	B	Q	b	q	B	Q	b	q	B	Q
03	c	r	C	R	c	r	C	R	c	r	C	R
04	d	s	D	S	d	s	D	S	d	s	D	S
05	e	t	E	T	e	t	E	T	e	t	E	T
06	f	u	F	U	f	u	F	U	f	u	F	U
07	g	v	G	V	g	v	G	V	g	v	G	V
08	h	x	H	X	h	x	H	X	h	x	H	X
09	j	y	J	Y	j	y	J	Y	j	y	J	Y
10	k	z	K	Z	k	z	K	Z	k	z	K	Z
11	l	2	L	4	l	2	L	4	l	2	L	4
12	n	3	N	5	n	3	N	5	n	3	N	5

1) New Marking Layout for SC75, implemented at October 2005.

Package Outline

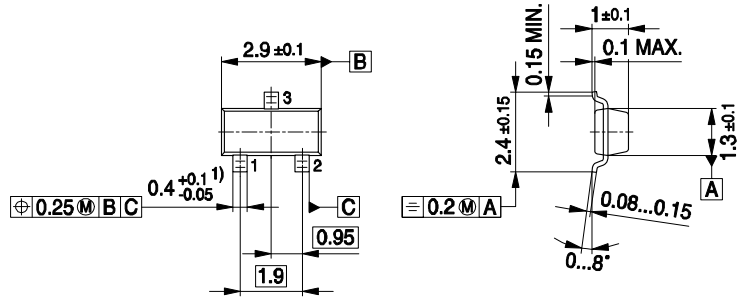
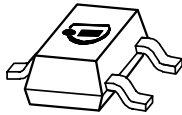

1) Lead width can be 0.6 max. in dambar area

SOT23-PO V08

Foot Print

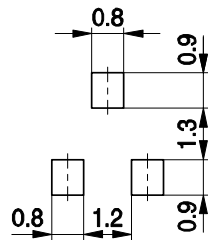

SOT23-FPR V08

Marking Layout

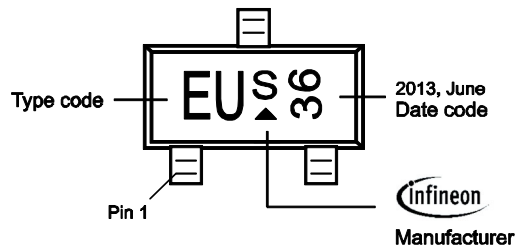

Standard Packing

Reel o 180 mm: 3.000 Pieces / Reel
 Reel o 330 mm = 10.000 Pieces / Reel

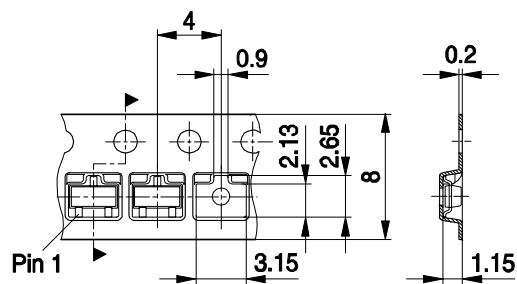

SOT23-TP V02

Package Outline

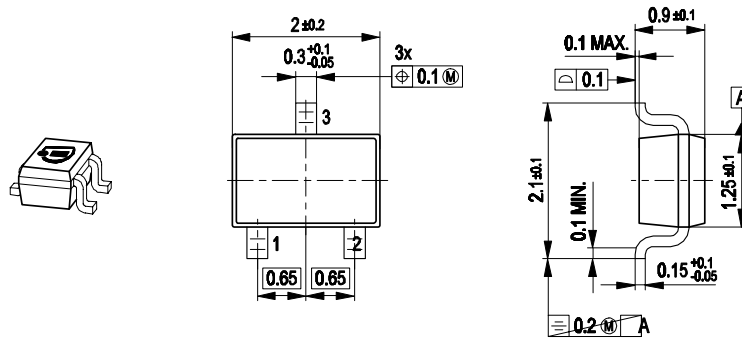

Foot Print

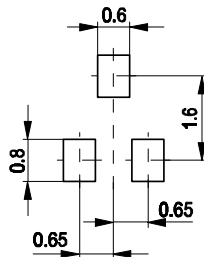

Marking Layout (Example)

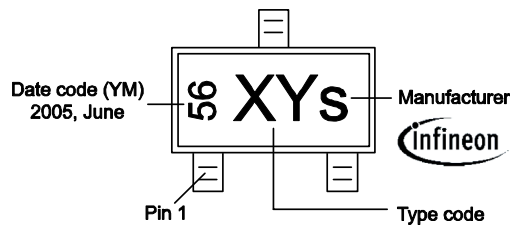

Standard Packing

Reel ø180 mm = 3.000 Pieces/Reel
 Reel ø330 mm = 10.000 Pieces/Reel

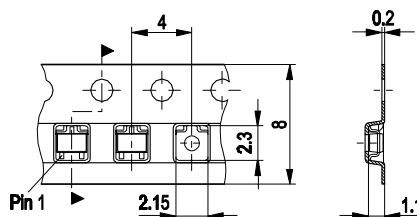

Edition 2009-11-16

**Published by
Infineon Technologies AG
81726 Munich, Germany**

**© 2009 Infineon Technologies AG
All Rights Reserved.**

Legal Disclaimer

The information given in this document shall in no event be regarded as a guarantee of conditions or characteristics. With respect to any examples or hints given herein, any typical values stated herein and/or any information regarding the application of the device, Infineon Technologies hereby disclaims any and all warranties and liabilities of any kind, including without limitation, warranties of non-infringement of intellectual property rights of any third party.

Information

For further information on technology, delivery terms and conditions and prices, please contact the nearest Infineon Technologies Office (www.infineon.com).

Warnings

Due to technical requirements, components may contain dangerous substances. For information on the types in question, please contact the nearest Infineon Technologies Office.

Infineon Technologies components may be used in life-support devices or systems only with the express written approval of Infineon Technologies, if a failure of such components can reasonably be expected to cause the failure of that life-support device or system or to affect the safety or effectiveness of that device or system. Life support devices or systems are intended to be implanted in the human body or to support and/or maintain and sustain and/or protect human life. If they fail, it is reasonable to assume that the health of the user or other persons may be endangered.

Mouser Electronics

Authorized Distributor

Click to View Pricing, Inventory, Delivery & Lifecycle Information:

[Infineon:](#)

[BAT6402VH6327XTSA1](#)