

TVS Diode

Transient Voltage Suppressor Diodes

ESD300-B1-02LRH

Low Clamping & Low Capacitance ESD/Surge Protection Diode

ESD300-B1-02LRH

Data Sheet

Revision 1.2, 2013-11-26
Final

Revision History: Revision 1.1, 2013-06-17

Page or Item	Subjects (major changes since previous revision)
Revision 1.2, 2013-11-26	
4	Update of Figure 2-1)

Trademarks of Infineon Technologies AG

AURIX™, BlueMoon™, C166™, CanPAK™, CIPOS™, CIPURSE™, COMNEON™, EconoPACK™, CoolMOS™, CoolSET™, CORECONTROL™, CROSSAVE™, DAVE™, EasyPIM™, EconoBRIDGE™, EconoDUAL™, EconoPIM™, EiceDRIVER™, eupec™, FCOS™, HITFET™, HybridPACK™, I²RF™, ISOFACE™, IsoPACK™, MIPAQ™, ModSTACK™, my-d™, NovalithIC™, OmniTune™, OptiMOS™, ORIGA™, PRIMARION™, PrimePACK™, PrimeSTACK™, PRO-SIL™, PROFET™, RASIC™, ReverSave™, SatRIC™, SIEGET™, SINDRION™, SIPMOS™, SMARTi™, SmartLEWIS™, SOLID FLASH™, TEMPFET™, thinQ!™, TRENCHSTOP™, TriCore™, X-GOLD™, X-PMU™, XMM™, XPOSYS™.

Other Trademarks

Advance Design System™ (ADS) of Agilent Technologies, AMBA™, ARM™, MULTI-ICE™, KEIL™, PRIMECELL™, REALVIEW™, THUMB™, μVision™ of ARM Limited, UK. AUTOSAR™ is licensed by AUTOSAR development partnership. Bluetooth™ of Bluetooth SIG Inc. CAT-ig™ of DECT Forum. COLOSSUS™, FirstGPS™ of Trimble Navigation Ltd. EMV™ of EMVCo, LLC (Visa Holdings Inc.). EPCOS™ of Epcos AG. FLEXGO™ of Microsoft Corporation. FlexRay™ is licensed by FlexRay Consortium. HYPERTERMINAL™ of Hilgraeve Incorporated. IEC™ of Commission Electrotechnique Internationale. IrDA™ of Infrared Data Association Corporation. ISO™ of INTERNATIONAL ORGANIZATION FOR STANDARDIZATION. MATLAB™ of MathWorks, Inc. MAXIM™ of Maxim Integrated Products, Inc. MICROTEC™, NUCLEUS™ of Mentor Graphics Corporation. Mifare™ of NXP. MIPI™ of MIPI Alliance, Inc. MIPS™ of MIPS Technologies, Inc., USA. muRata™ of MURATA MANUFACTURING CO., MICROWAVE OFFICE™ (MWO) of Applied Wave Research Inc., OmniVision™ of OmniVision Technologies, Inc. Openwave™ Openwave Systems Inc. RED HAT™ Red Hat, Inc. RFMD™ RF Micro Devices, Inc. SIRIUS™ of Sirius Satellite Radio Inc. SOLARIS™ of Sun Microsystems, Inc. SPANSION™ of Spansion LLC Ltd. Symbian™ of Symbian Software Limited. TAIYO YUDEN™ of Taiyo Yuden Co. TEAKLITE™ of CEVA, Inc. TEKTRONIX™ of Tektronix Inc. TOKO™ of TOKO KABUSHIKI KAISHA TA. UNIX™ of X/Open Company Limited. VERILOG™, PALLADIUM™ of Cadence Design Systems, Inc. VLYNQ™ of Texas Instruments Incorporated. VXWORKS™, WIND RIVER™ of WIND RIVER SYSTEMS, INC. ZETEX™ of Diodes Zetex Limited.

Last Trademarks Update 2010-10-26

1 Low Clamping & Low Capacitance ESD/Surge Protection Diode

1.1 Features

- Extremely high ESD and surge protection
 - IEC61000-4-2 (ESD): ± 30 kV (air/contact discharge)
 - IEC61000-4-5 (surge): ± 18 A (8/20 μ s)
- Low clamping voltage $V_{CL} < 8$ V (8 kV contact)
- Maximum peak pulse power $P_{PP} = 260$ W (8/20 μ s)
- Extremely low dynamic resistance: $R_{DYN} = 0.23$ Ω typ.
- Supports applications with signal voltage 3.3 V max.
- Line capacitance: $C_L = \text{typ. } 1.2$ pF
- Package TSLP-2-17 compatible to SOD882D leadless ultra small Surface-Mounted Device (SMD)
- Size 1 mm x 0.6 mm x 0.39 mm (0402)



1.2 Application Examples

- Reliable ESD and surge protection of highly susceptible IC/ASICs in computers and peripherals, audio, headset, human digital interfaces, video equipment, cellular handsets and accessories and portable electronics
- Dedicated solution to boost ESD and surge protection performance in miniaturized modern electronics
- 10/100/1000 Ethernet

1.3 Product Description



Figure 1-1 Pin Configuration and Schematic Diagram

Table 1-1 Ordering Information

Type	Package	Configuration	Marking code
ESD300-B1-02LRH	TSLP-2-17	1 line, bi-directional	S3

2 Characteristics

2.1 Maximum Ratings

Table 2-1 Maximum Ratings at $T_A = 25\text{ °C}$, unless otherwise specified

Parameter	Symbol	Values			Unit
		Min.	Typ.	Max.	
ESD ¹⁾ contact discharge air discharge	V_{ESD}	-30 -30	- -	30 30	kV
Peak pulse current ($t_p = 8/20\ \mu\text{s}$) ²⁾	I_{PP}	-18	-	18	A
Peak pulse power ($t_p = 8/20\ \mu\text{s}$) ²⁾	P_{PP}	-	-	260	W
Operating temperature range	T_{OP}	-55	-	125	°C
Storage temperature	T_{stg}	-65	-	150	°C

- 1) V_{ESD} according to IEC61000-4-2 ($R = 330\ \Omega$, $C = 150\ \text{pF}$ discharge network)
- 2) I_{PP} according to IEC61000-4-5 ($t_p = 8/20\ \mu\text{s}$)

Attention: Stresses above the max. values listed here may cause permanent damage to the device. Exposure to absolute maximum rating conditions for extended periods may affect device reliability. Maximum ratings are absolute ratings; exceeding only one of these values may cause irreversible damage to the integrated circuit.

2.2 Electrical Characteristics at $T_A = 25\text{ °C}$, unless otherwise specified

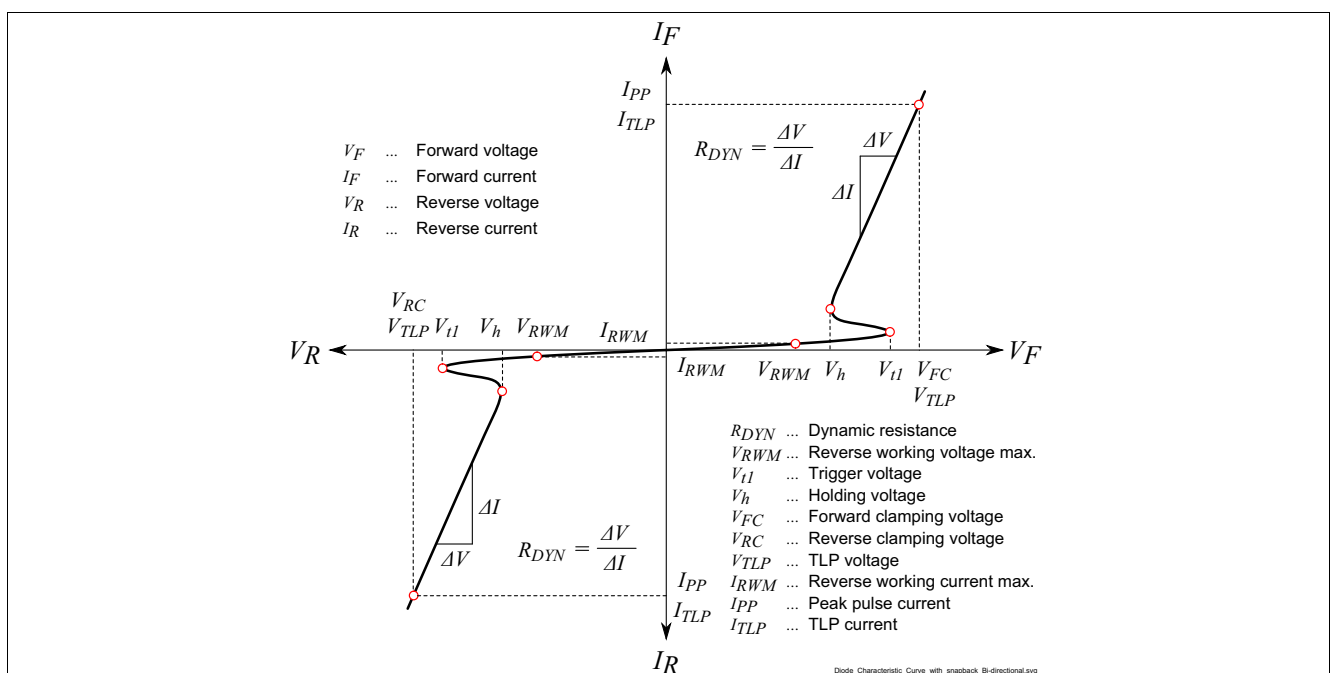

Figure 2-1 Definitions of electrical characteristics

Table 2-2 DC Characteristics at $T_A = 25\text{ }^\circ\text{C}$, unless otherwise specified

Parameter	Symbol	Values			Unit	Note / Test Condition
		Min.	Typ.	Max.		
Reverse working voltage	V_{RWM}	-3.3	-	3.3	V	
Reverse current	I_R	-	-	100	nA	$V_R = 3.3\text{ V}$

Table 2-3 RF Characteristics at $T_A = 25\text{ }^\circ\text{C}$, unless otherwise specified

Parameter	Symbol	Values			Unit	Note / Test Condition
		Min.	Typ.	Max.		
Line capacitance	C_L	-	1.2	1.8	pF	$V_R = 0\text{ V}, f = 1\text{ MHz}$

Table 2-4 ESD Characteristics at $T_A = 25\text{ }^\circ\text{C}$, unless otherwise specified

Parameter	Symbol	Values			Unit	Note / Test Condition
		Min.	Typ.	Max.		
Clamping voltage ¹⁾	V_{CL}	-	8	-	V	$V_{ESD} = 8\text{ kV}, t_p = 30\text{ ns}$ contact discharge
Clamping voltage ²⁾	V_{CL}	-	5	-	V	$t_p = 8/20\text{ }\mu\text{s}$ $I_{PP} = 1\text{ A}$ $I_{PP} = 12\text{ A}$ $I_{PP} = 18\text{ A}$
		-	8.5	-		
		-	10.5	-		
Clamping voltage ³⁾	V_{CL}	-	9.5	-	V	$t_p = 100\text{ ns}$ $I_{PP} = 16\text{ A}$ $I_{PP} = 30\text{ A}$
		-	12.5	-		
Dynamic resistance ³⁾	R_{DYN}	-	0.23	-	Ω	

1) V_{ESD} according to IEC61000-4-2 ($R = 330\text{ }\Omega, C = 150\text{ pF}$ discharge network)

2) I_{PP} according to IEC61000-4-5 ($t_p = 8/20\text{ }\mu\text{s}$)

3) ANSI/ESD STM5.5.1 - Electrostatic Discharge Sensitive Testing using Transmission Line Pulse (TLP) Model. TLP conditions: $Z_0 = 50\text{ }\Omega, t_p = 100\text{ ns}, t_r = 0.6\text{ ns}, I_{TLP}$ and V_{TLP} averaging window: $t_1 = 30\text{ ns}$ to $t_2 = 60\text{ ns}$, extraction of dynamic resistance using least squares fit of TLP characteristic between $I_{TLP1} = 10\text{ A}$ and $I_{TLP2} = 40\text{ A}$. Please refer to Application Note AN210 [1]

Typical Characteristics at $T_A = 25\text{ }^\circ\text{C}$, unless otherwise specified

3 Typical Characteristics at $T_A = 25\text{ }^\circ\text{C}$, unless otherwise specified

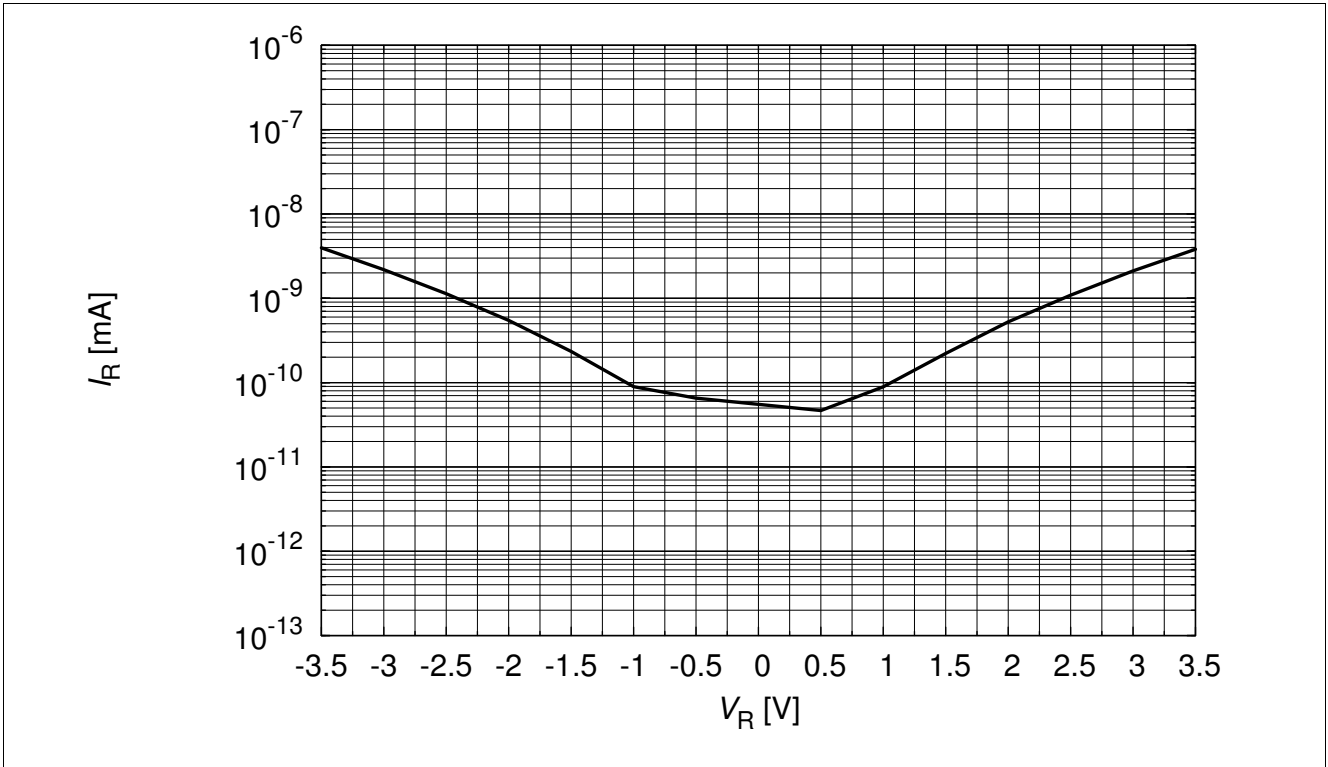

Figure 3-1 Reverse current: $I_R = f(V_R)$

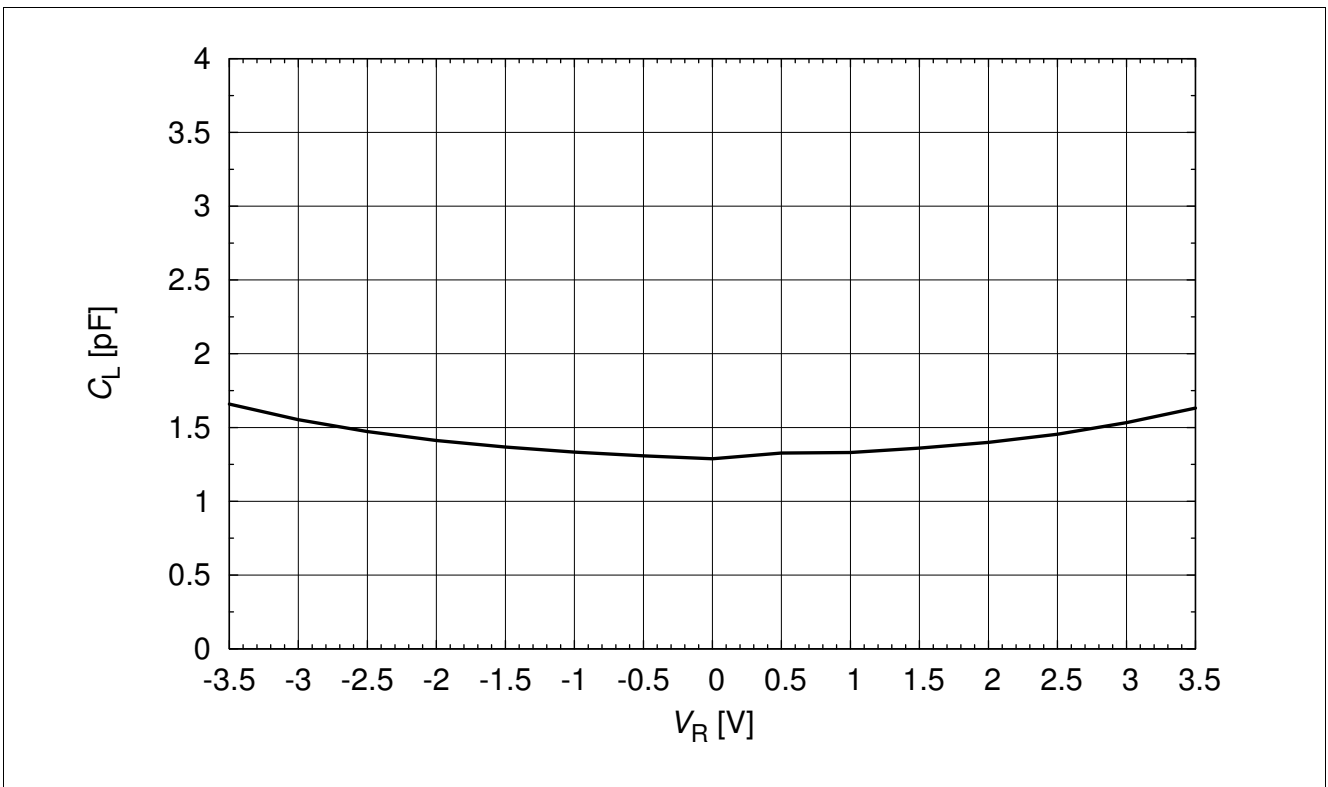

Figure 3-2 Line capacitance: $C_L = f(V_R), f = 1\text{ MHz}$

Typical Characteristics at $T_A = 25\text{ }^\circ\text{C}$, unless otherwise specified

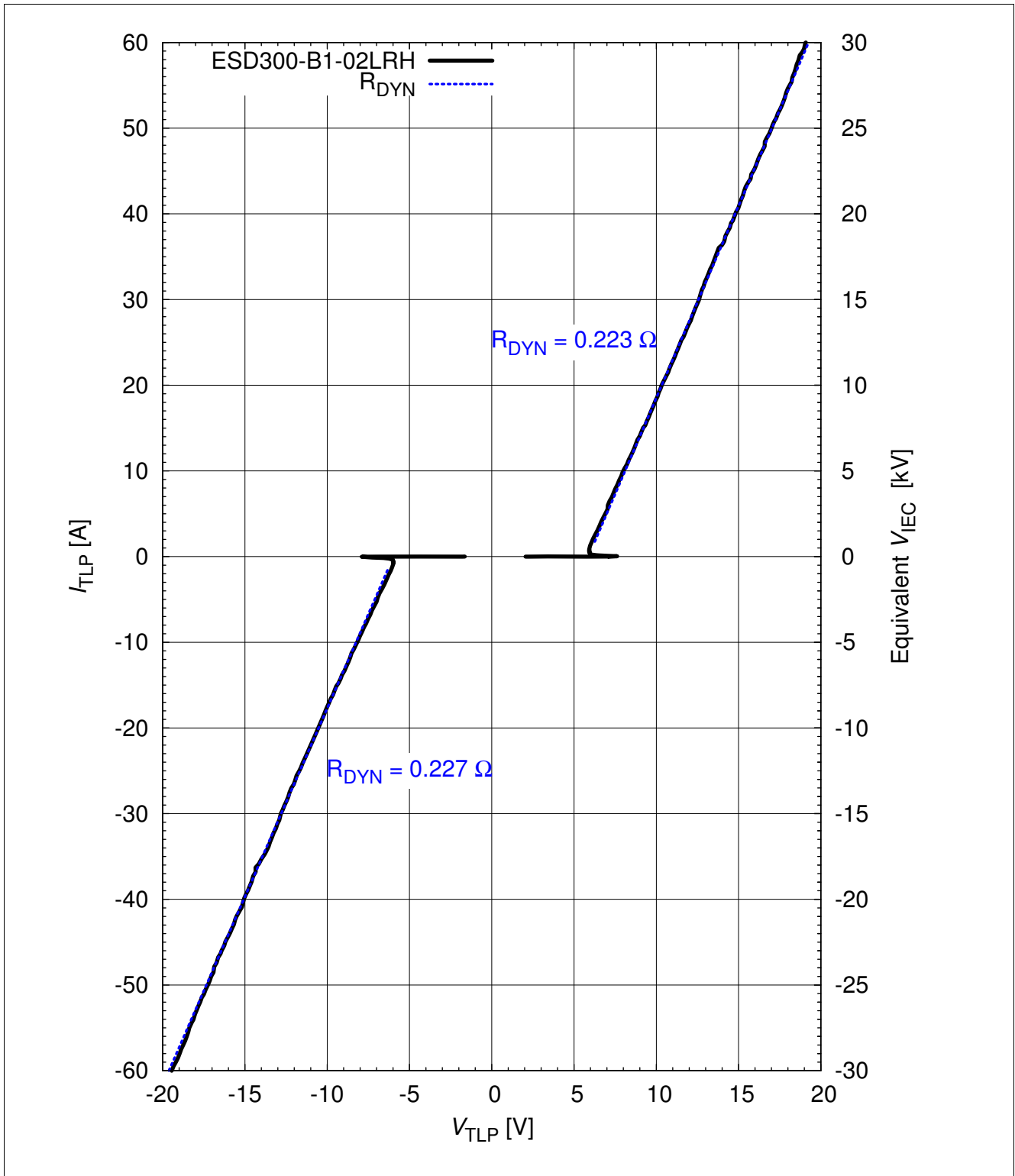

Figure 3-3 Clamping voltage (TLP): $I_{TLP} = f(V_{TLP})$ according ANSI/ESD STM5.5.1 - Electrostatic Discharge Sensitivity Testing using Transmission Line Pulse (TLP) Model. TLP conditions: $Z_0 = 50\ \Omega$, $t_p = 100\text{ ns}$, $t_r = 0.6\text{ ns}$, I_{TLP} and V_{TLP} averaging window: $t_1 = \text{ns}$ to $t_2 = 60\text{ ns}$, extraction of dynamic resistance using squares fit to TLP characteristics between $I_{TLP1} = 10\text{ A}$ and $I_{TLP2} = 40\text{ A}$. Please refer to Application Note AN210 [1]

Typical Characteristics at $T_A = 25\text{ }^\circ\text{C}$, unless otherwise specified

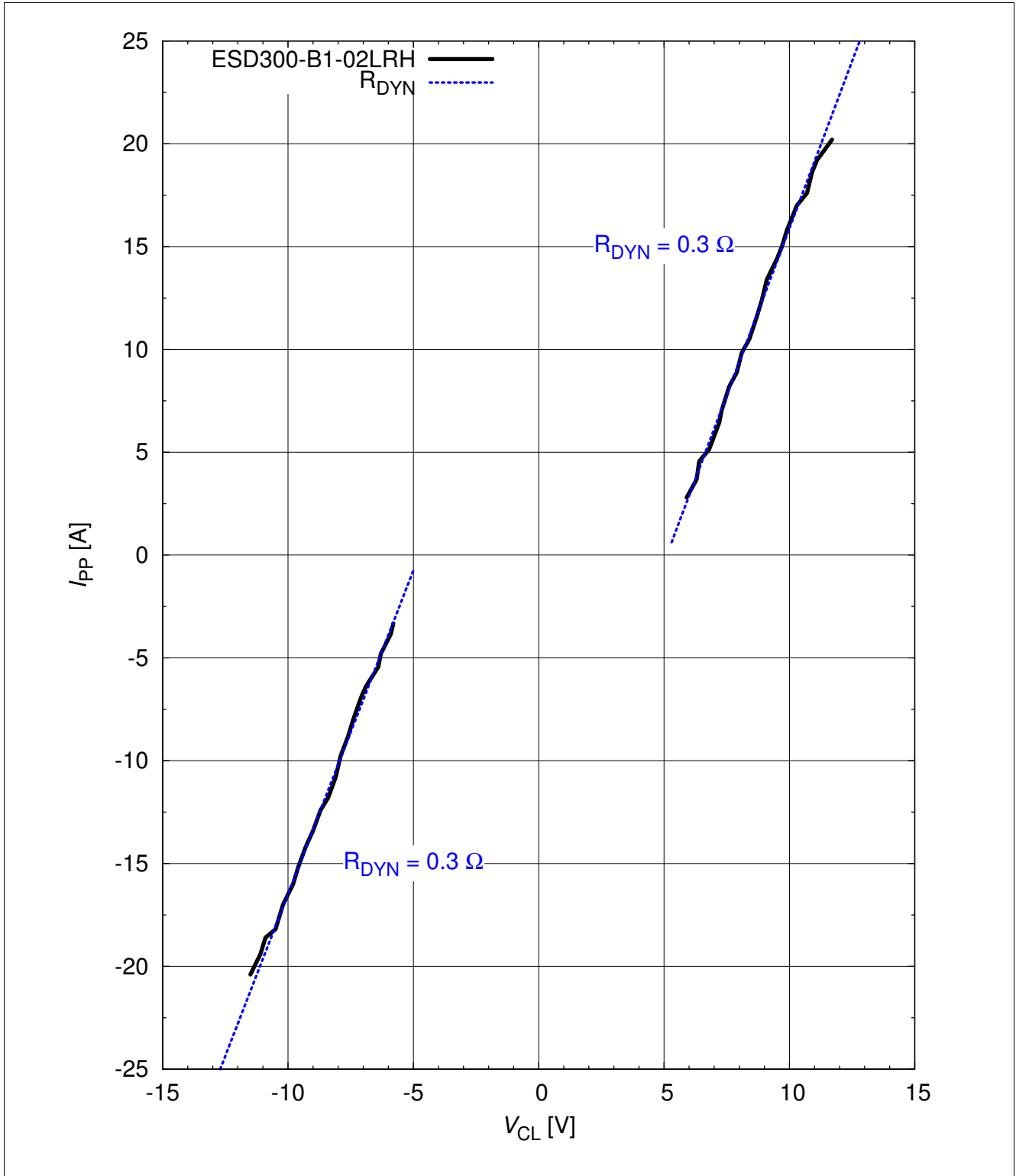

Figure 3-4 Pulse current (IEC61000-4-5) versus clamping voltage: $I_{PP} = f(V_{CL})$

Typical Characteristics at $T_A = 25\text{ }^\circ\text{C}$, unless otherwise specified

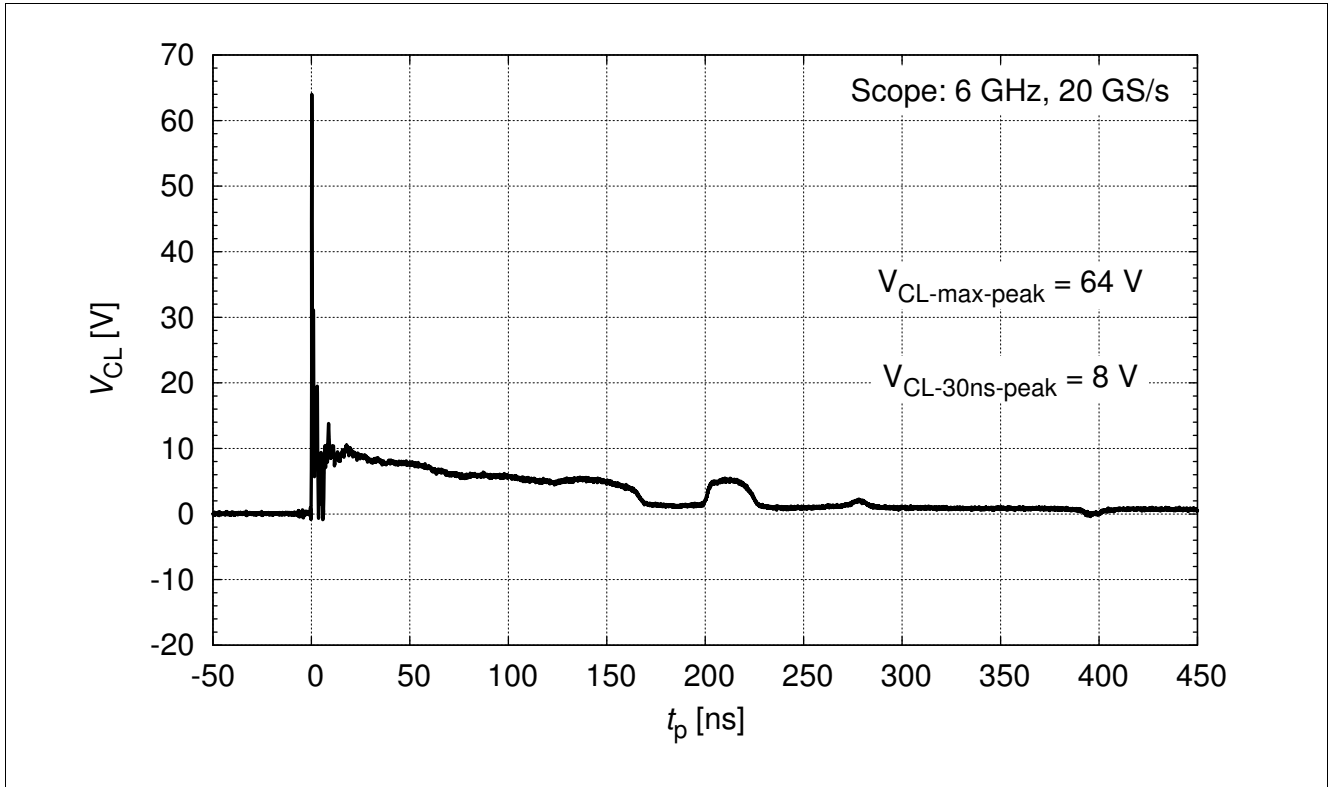

Figure 3-5 IEC61000-4-2 : $V_{CL} = f(t)$, 8 kV positive pulse from pin 1 to pin 2

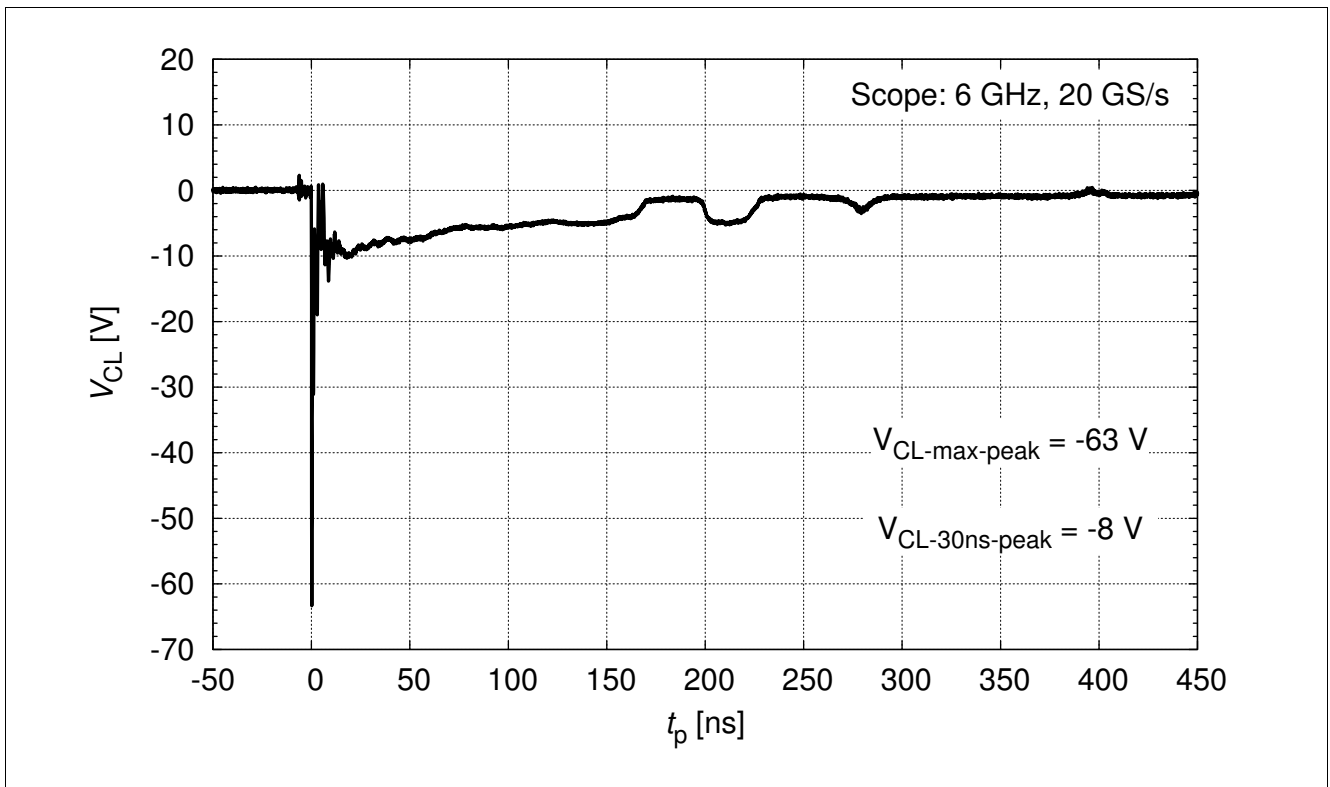

Figure 3-6 IEC61000-4-2 : $V_{CL} = f(t)$, 8 kV negative pulse from pin 1 to pin 2

Typical Characteristics at $T_A = 25\text{ }^\circ\text{C}$, unless otherwise specified

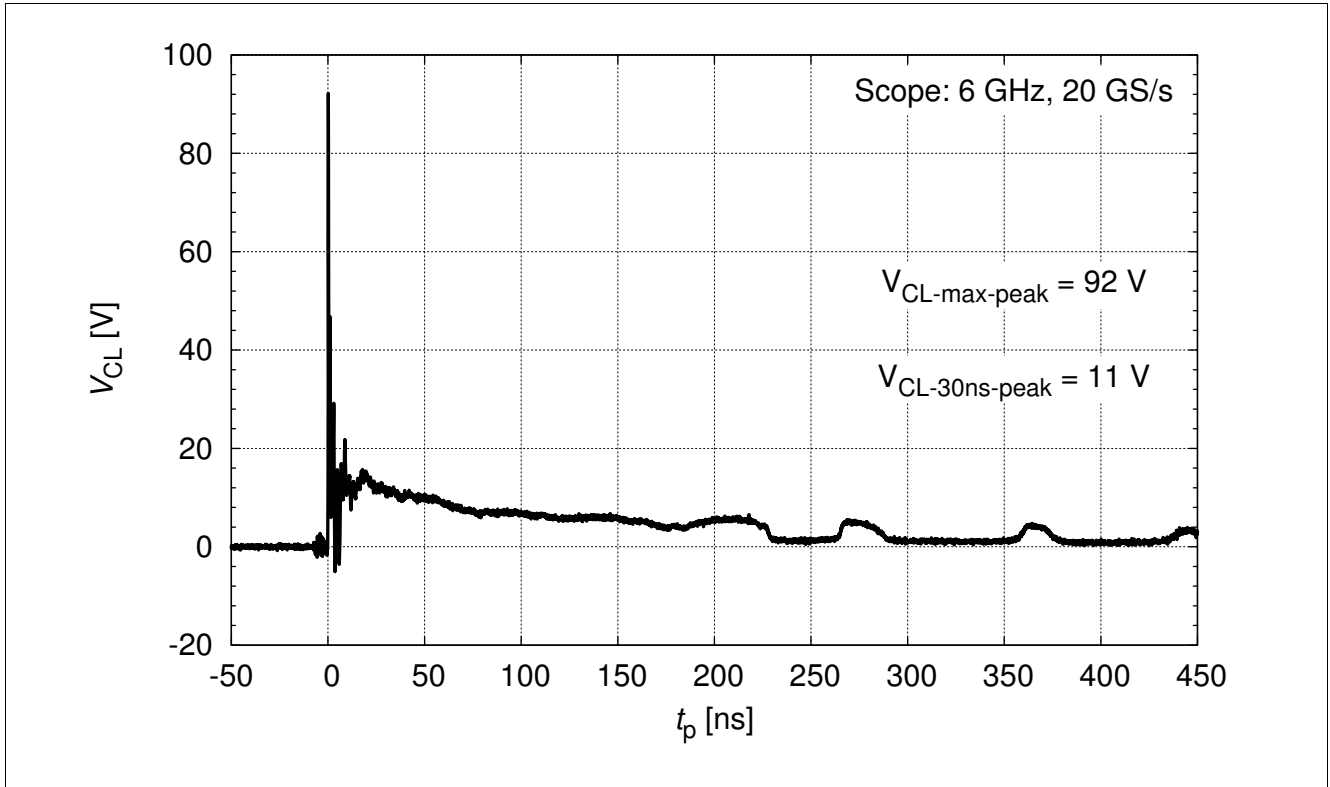

Figure 3-7 IEC61000-4-2 : $V_{CL} = f(t)$, 15 kV positive pulse from pin 1 to pin 2

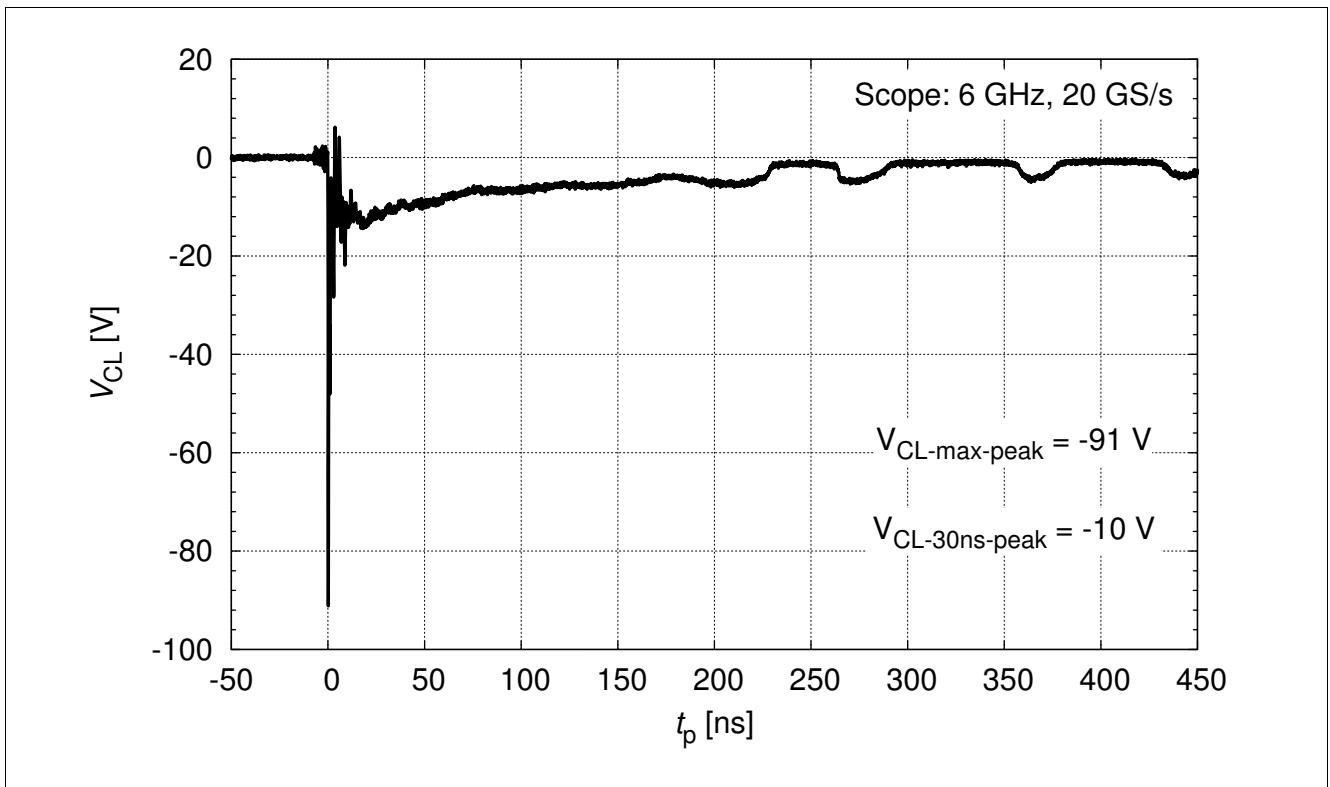

Figure 3-8 IEC61000-4-2 : $V_{CL} = f(t)$, 15 kV negative pulse from pin 1 to pin 2

4 Package Information

4.1 TSLP-2-17

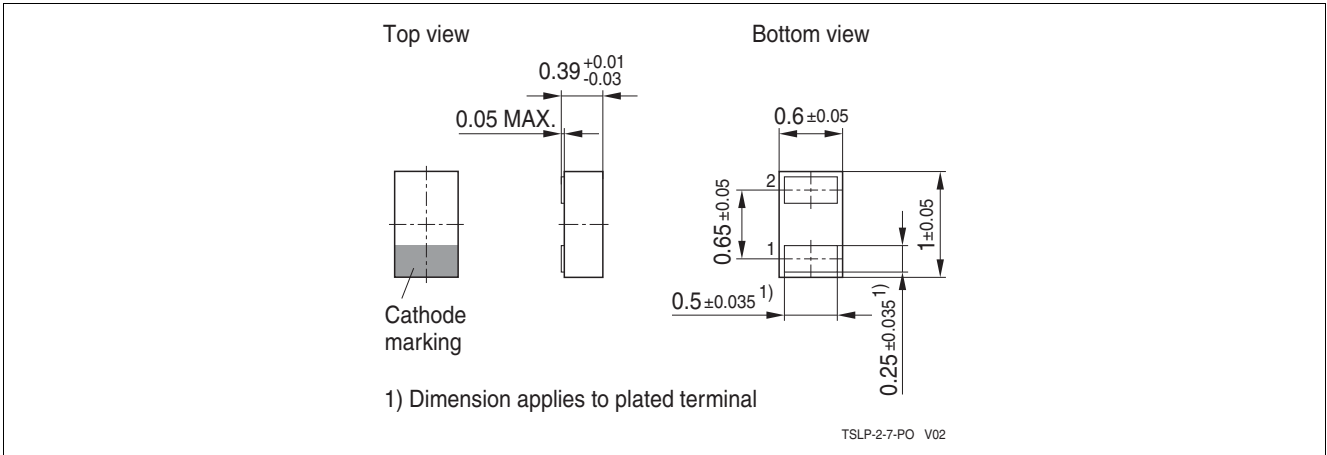

Figure 4-1 TSLP-2-17 Package outline (dimension in mm)

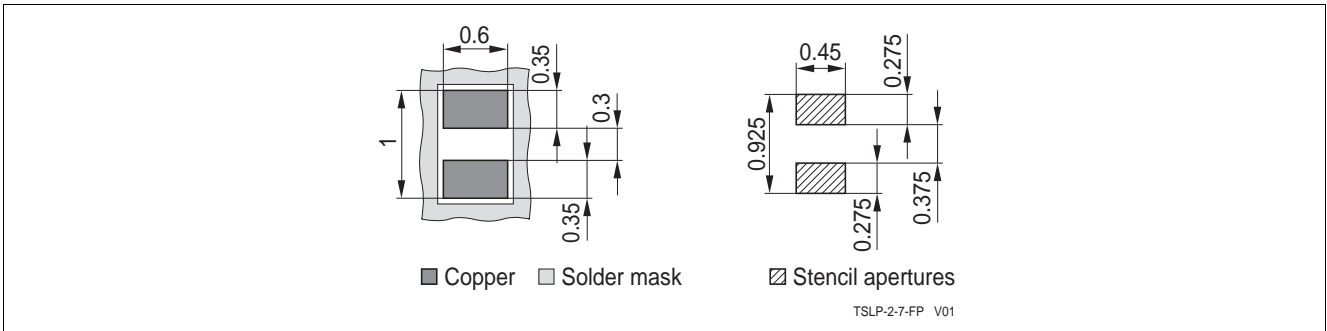

Figure 4-2 TSLP-2-17 Footprint (dimension in mm)

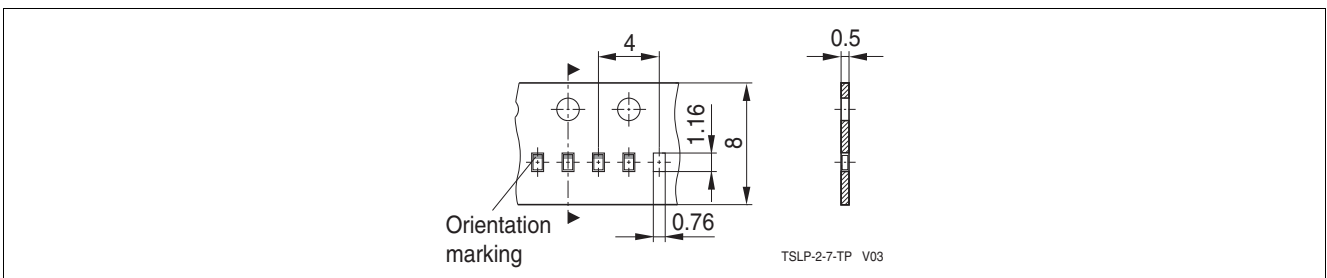

Figure 4-3 TSLP-2-17 Packing (dimension in mm)

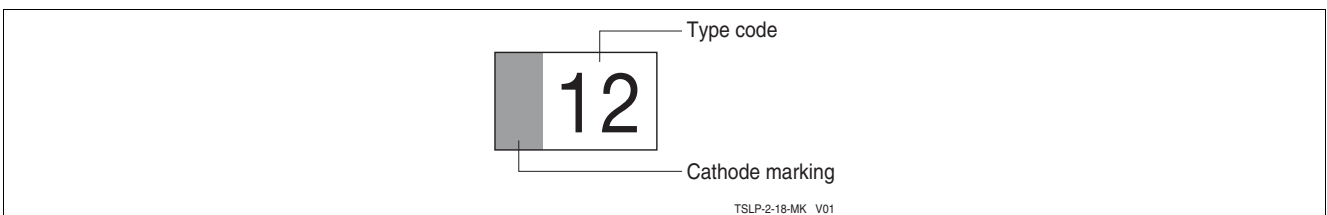

Figure 4-4 TSLP-2-17 Marking (example)

References

- [1] Infineon AG - **Application Note AN210**: Effective ESD Protection design at System Level Using VF-TLP Characterization Methodology

www.infineon.com

Published by Infineon Technologies AG

Mouser Electronics

Authorized Distributor

Click to View Pricing, Inventory, Delivery & Lifecycle Information:

[Infineon:](#)

[ESD300B102LRHE6327XTSA1](#)