

## Resonant Switching Series

Reverse conducting IGBT with monolithic body diode

IHW30N110R3

Data sheet

Industrial Power Control

### Reverse conducting IGBT with monolithic body diode

#### Features:

- Powerful monolithic body diode with low forward voltage designed for soft commutation only
- Very tight parameter distribution
- High ruggedness, temperature stable behavior
- Low  $V_{CEsat}$
- Easy parallel switching capability due to positive temperature coefficient in  $V_{CEsat}$
- Low EMI
- Qualified according to JEDEC for target applications
- Pb-free lead plating; RoHS compliant
- Complete product spectrum and PSpice Models:  
<http://www.infineon.com/igbt/>

#### Applications:

- Inductive cooking
- Inverterized microwave ovens
- Resonant converters
- Soft switching applications

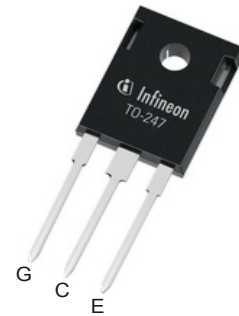
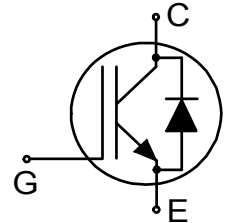

#### Key Performance and Package Parameters

| Type        | $V_{CE}$ | $I_C$ | $V_{CEsat}, T_{vj}=25^{\circ}C$ | $T_{vjmax}$ | Marking  | Package    |
|-------------|----------|-------|---------------------------------|-------------|----------|------------|
| IHW30N110R3 | 1100V    | 30A   | 1.55V                           | 175°C       | H30R1103 | PG-TO247-3 |



**Table of Contents**

Description ..... 2

Table of Contents ..... 3

Maximum Ratings ..... 4

Thermal Resistance ..... 4

Electrical Characteristics ..... 5

Electrical Characteristics Diagrams ..... 7

Package Drawing .....13

Testing Conditions .....14

Revision History .....15

Disclaimer .....15

**Maximum Ratings**

For optimum lifetime and reliability, Infineon recommends operating conditions that do not exceed 80% of the maximum ratings stated in this datasheet.

| Parameter  | Symbol      | Value                | Unit             |
|--|-------------|----------------------|------------------|
| Collector-emitter voltage  | $V_{CE}$    | 1100                 | V                |
| DC collector current, limited by $T_{vjmax}$<br>$T_C = 25^\circ\text{C}$<br>$T_C = 100^\circ\text{C}$  | $I_C$       | 60.0<br>30.0         | A                |
| Pulsed collector current, $t_p$ limited by $T_{vjmax}$   | $I_{Cpuls}$ | 90.0                 | A                |
| Turn off safe operating area $V_{CE} \leq 1100\text{V}$ , $T_{vj} \leq 175^\circ\text{C}$              | -           | 90.0                 | A                |
| Diode forward current, limited by $T_{vjmax}$<br>$T_C = 25^\circ\text{C}$<br>$T_C = 100^\circ\text{C}$ | $I_F$       | 60.0<br>30.0         | A                |
| Diode pulsed current, $t_p$ limited by $T_{vjmax}$   | $I_{Fpuls}$ | 90.0                 | A                |
| Gate-emitter voltage<br>Transient Gate-emitter voltage ( $t_p \leq 10\mu\text{s}$ , $D < 0.010$ )      | $V_{GE}$    | $\pm 20$<br>$\pm 25$ | V                |
| Power dissipation $T_C = 25^\circ\text{C}$<br>Power dissipation $T_C = 100^\circ\text{C}$              | $P_{tot}$   | 333.0<br>166.0       | W                |
| Operating junction temperature   | $T_{vj}$    | -40...+175           | $^\circ\text{C}$ |
| Storage temperature  | $T_{stg}$   | -55...+175           | $^\circ\text{C}$ |
| Soldering temperature,<br>wave soldering 1.6mm (0.063in.) from case for 10s                            |             | 260                  | $^\circ\text{C}$ |
| Mounting torque, M3 screw<br>Maximum of mounting processes: 3  | $M$         | 0.6                  | Nm               |

**Thermal Resistance**

| Parameter                                    | Symbol        | Conditions | Max. Value | Unit |
|--|---------------|------------|------------|------|
| <b>Characteristic</b>                        |               |            |            |      |
| IGBT thermal resistance,<br>junction - case  | $R_{th(j-c)}$ |            | 0.45       | K/W  |
| Diode thermal resistance,<br>junction - case | $R_{th(j-c)}$ |            | 0.45       | K/W  |
| Thermal resistance<br>junction - ambient     | $R_{th(j-a)}$ |            | 40         | K/W  |

**Electrical Characteristic, at  $T_{vj} = 25^{\circ}\text{C}$ , unless otherwise specified**

| Parameter                            | Symbol        | Conditions   | Value       |                      |                | Unit          |
|--------------------------------------|---------------|--|-------------|----------------------|----------------|---------------|
|                                      |               |  | min.        | typ.                 | max.           |               |
| <b>Static Characteristic</b>         |               |  |             |                      |                |               |
| Collector-emitter breakdown voltage  | $V_{(BR)CES}$ | $V_{GE} = 0\text{V}, I_C = 0.50\text{mA}$  | 1100        | -                    | -              | V             |
| Collector-emitter saturation voltage | $V_{CEsat}$   | $V_{GE} = 15.0\text{V}, I_C = 30.0\text{A}$<br>$T_{vj} = 25^{\circ}\text{C}$<br>$T_{vj} = 125^{\circ}\text{C}$<br>$T_{vj} = 175^{\circ}\text{C}$ | -<br>-<br>- | 1.55<br>1.85<br>2.00 | 1.75<br>-<br>- | V             |
| Diode forward voltage                | $V_F$         | $V_{GE} = 0\text{V}, I_F = 30.0\text{A}$<br>$T_{vj} = 25^{\circ}\text{C}$<br>$T_{vj} = 125^{\circ}\text{C}$<br>$T_{vj} = 175^{\circ}\text{C}$    | -<br>-<br>- | 1.35<br>1.38<br>1.41 | 1.55<br>-<br>- | V             |
| Gate-emitter threshold voltage       | $V_{GE(th)}$  | $I_C = 0.70\text{mA}, V_{CE} = V_{GE}$   | 5.1         | 5.8                  | 6.4            | V             |
| Zero gate voltage collector current  | $I_{CES}$     | $V_{CE} = 1100\text{V}, V_{GE} = 0\text{V}$<br>$T_{vj} = 25^{\circ}\text{C}$<br>$T_{vj} = 175^{\circ}\text{C}$                                   | -<br>-      | -<br>-               | 5.0<br>2500.0  | $\mu\text{A}$ |
| Gate-emitter leakage current         | $I_{GES}$     | $V_{CE} = 0\text{V}, V_{GE} = 20\text{V}$  | -           | -                    | 100            | nA            |
| Transconductance                     | $g_{fs}$      | $V_{CE} = 20\text{V}, I_C = 30.0\text{A}$  | -           | 15.0                 | -              | S             |
| Integrated gate resistor             | $r_G$         |  |             | none                 |                | $\Omega$      |

**Electrical Characteristic, at  $T_{vj} = 25^{\circ}\text{C}$ , unless otherwise specified**

| Parameter  | Symbol    | Conditions   | Value |       |      | Unit |
|--|-----------|--|-------|-------|------|------|
|  |           |  | min.  | typ.  | max. |      |
| <b>Dynamic Characteristic</b>  |           |  |       |       |      |      |
| Input capacitance  | $C_{ies}$ | $V_{CE} = 25\text{V}, V_{GE} = 0\text{V}, f = 1\text{MHz}$           | -     | 1460  | -    | pF   |
| Output capacitance   | $C_{oes}$ |  | -     | 55    | -    |      |
| Reverse transfer capacitance   | $C_{res}$ |  | -     | 45    | -    |      |
| Gate charge  | $Q_G$     | $V_{CC} = 880\text{V}, I_C = 30.0\text{A},$<br>$V_{GE} = 15\text{V}$ | -     | 180.0 | -    | nC   |
| Internal emitter inductance<br>measured 5mm (0.197 in.) from<br>case | $L_E$     |  | -     | 13.0  | -    | nH   |

**Switching Characteristic, Inductive Load**

| Parameter | Symbol | Conditions | Value |      |      | Unit |
|-----------|--------|------------|-------|------|------|------|
|           |        |            | min.  | typ. | max. |      |

**IGBT Characteristic, at  $T_{vj} = 25^{\circ}\text{C}$** 

|                     |              |  |   |      |   |    |
|---------------------|--------------|--|---|------|---|----|
| Turn-off delay time | $t_{d(off)}$ | $T_{vj} = 25^{\circ}\text{C},$<br>$V_{CC} = 600\text{V}, I_C = 30.0\text{A},$<br>$V_{GE} = 0.0/15.0\text{V},$<br>$R_{G(on)} = 15.0\Omega, R_{G(off)} = 15.0\Omega,$<br>$L_{\sigma} = 80\text{nH}, C_{\sigma} = 39\text{pF}$<br>$L_{\sigma}, C_{\sigma}$ from Fig. E<br>Energy losses include "tail" and<br>diode reverse recovery. | - | 350  | - | ns |
| Fall time           | $t_f$        |  | - | 16   | - | ns |
| Turn-off energy     | $E_{off}$    |  | - | 1.15 | - | mJ |

**Switching Characteristic, Inductive Load**

| Parameter  | Symbol       | Conditions   | Value |      |      | Unit |
|--|--------------|--|-------|------|------|------|
|  |              |  | min.  | typ. | max. |      |
| <b>IGBT Characteristic, at <math>T_{vj} = 175^{\circ}\text{C}</math></b> |              |  |       |      |      |      |
| Turn-off delay time  | $t_{d(off)}$ | $T_{vj} = 175^{\circ}\text{C},$  | -     | 410  | -    | ns   |
| Fall time  | $t_f$        | $V_{CC} = 600\text{V}, I_C = 30.0\text{A},$<br>$V_{GE} = 0.0/15.0\text{V},$  | -     | 60   | -    | ns   |
| Turn-off energy  | $E_{off}$    | $R_{G(on)} = 15.0\Omega, R_{G(off)} = 15.0\Omega,$<br>$L\sigma = 80\text{nH}, C\sigma = 39\text{pF}$<br>$L\sigma, C\sigma$ from Fig. E<br>Energy losses include "tail" and diode reverse recovery. | -     | 1.80 | -    | mJ   |

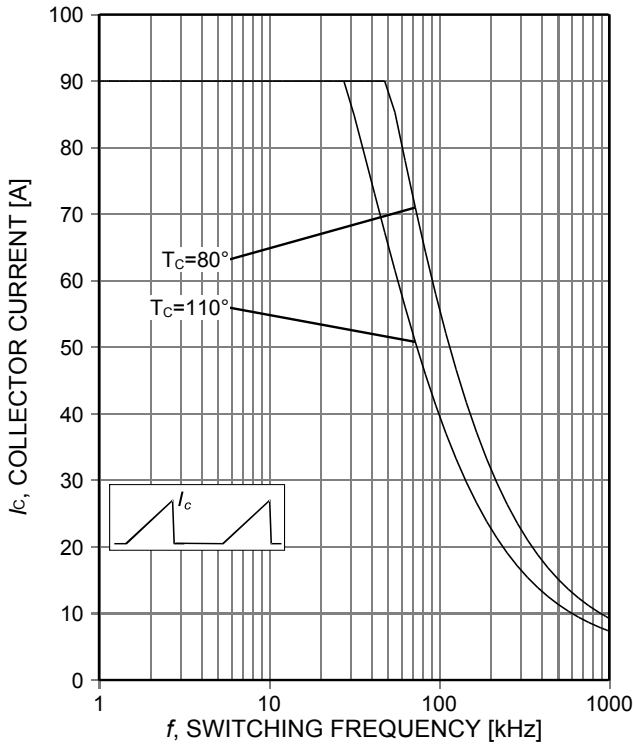

Figure 1. **Collector current as a function of switching frequency**  
 ( $T_j \leq 175^\circ\text{C}$ ,  $D=0.5$ ,  $V_{CE}=600\text{V}$ ,  $V_{GE}=0/15\text{V}$ ,  $R_\theta=15\Omega$ )

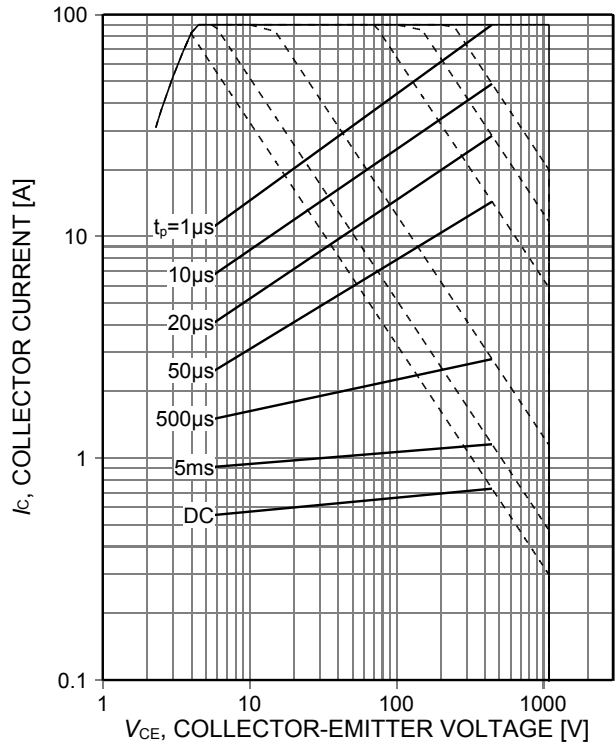

Figure 2. **Forward bias safe operating area**  
 ( $D=0$ ,  $T_C=25^\circ\text{C}$ ,  $T_j \leq 175^\circ\text{C}$ ;  $V_{GE}=15\text{V}$ )

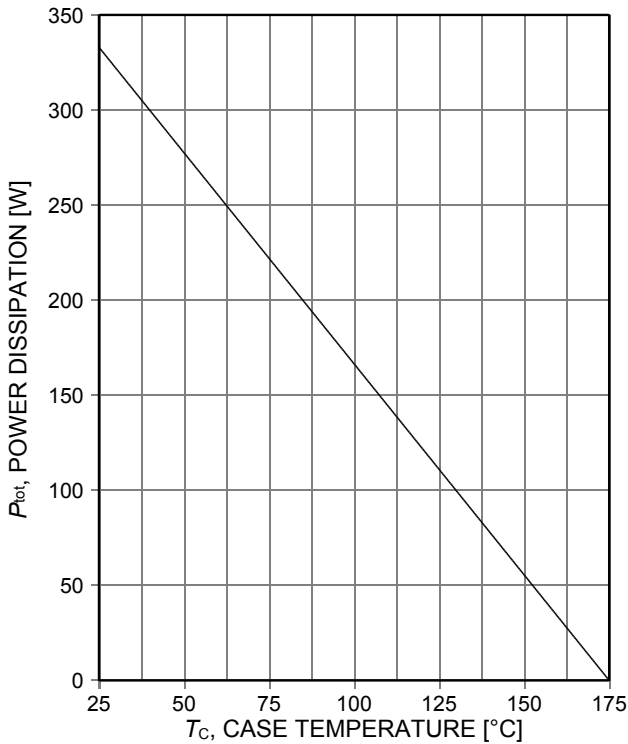

Figure 3. **Power dissipation as a function of case temperature**  
 ( $T_j \leq 175^\circ\text{C}$ )

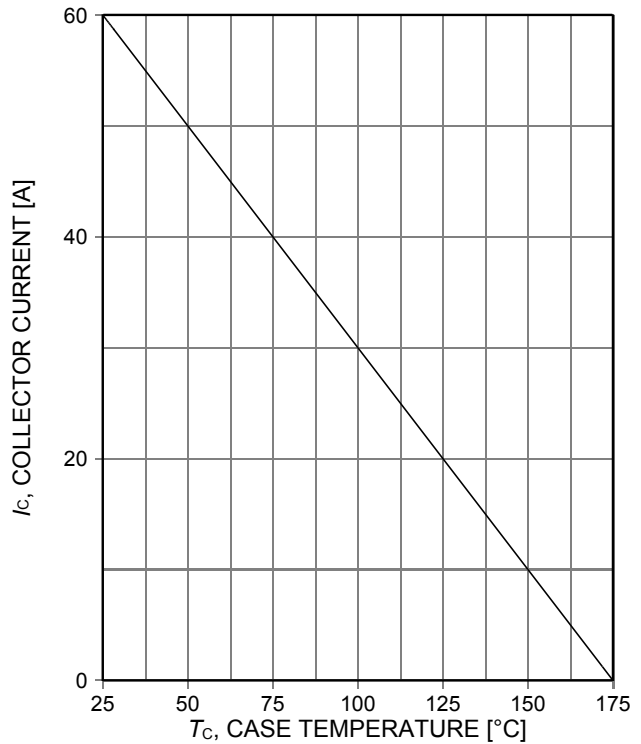

Figure 4. **Collector current as a function of case temperature**  
 ( $V_{GE} \geq 15\text{V}$ ,  $T_j \leq 175^\circ\text{C}$ )

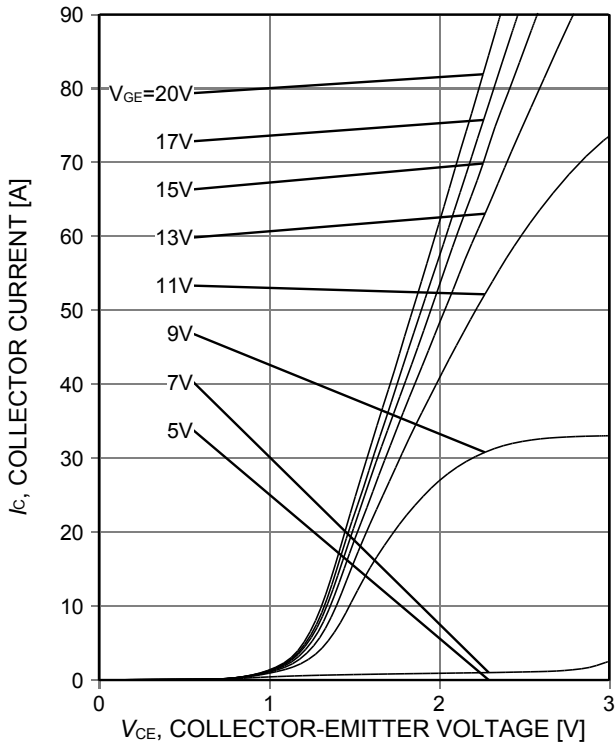

Figure 5. **Typical output characteristic**  
( $T_j=25^\circ\text{C}$ )

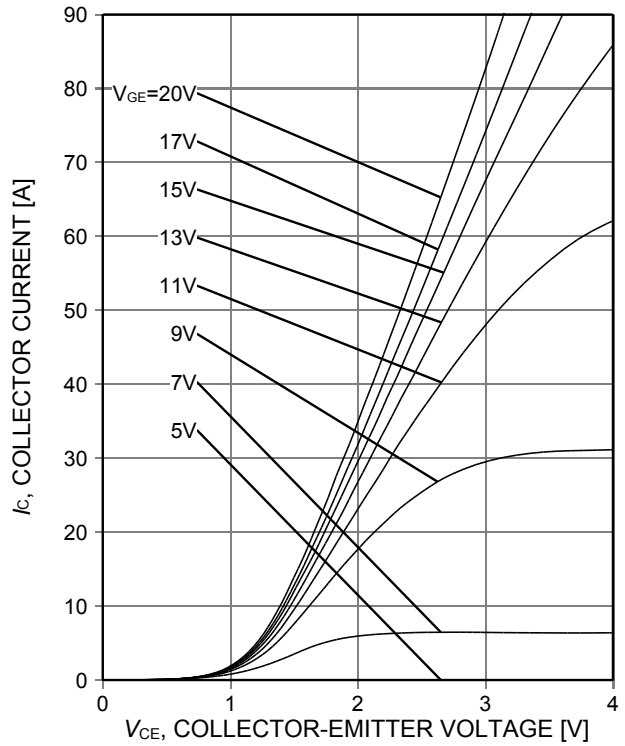

Figure 6. **Typical output characteristic**  
( $T_j=175^\circ\text{C}$ )

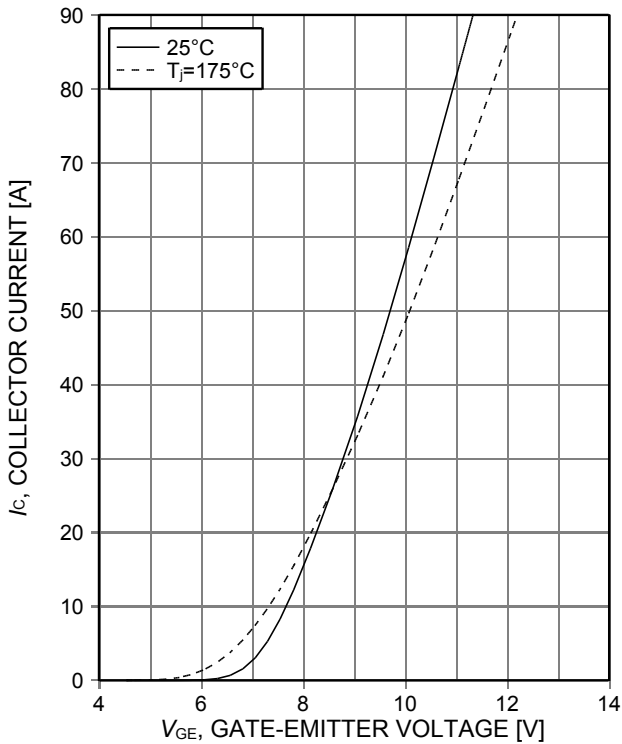

Figure 7. **Typical transfer characteristic**  
( $V_{CE}=20\text{V}$ )

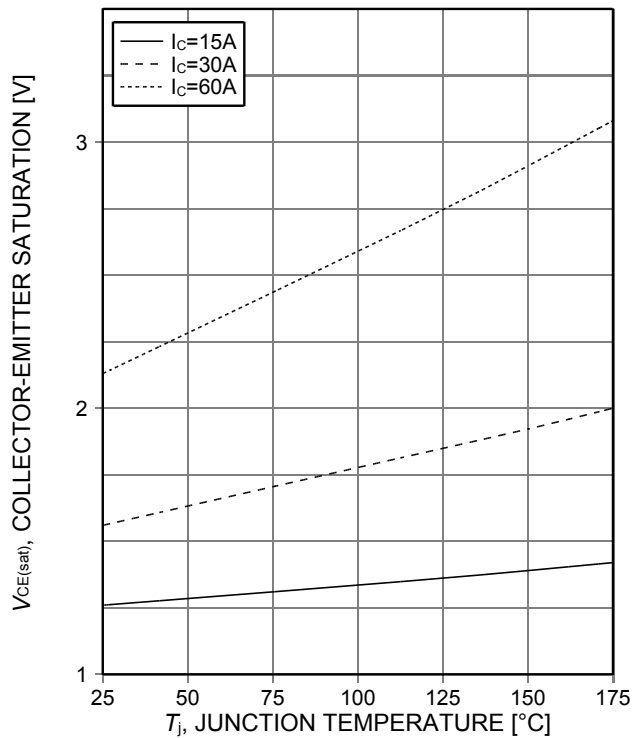

Figure 8. **Typical collector-emitter saturation voltage as a function of junction temperature**  
( $V_{GE}=15\text{V}$ )



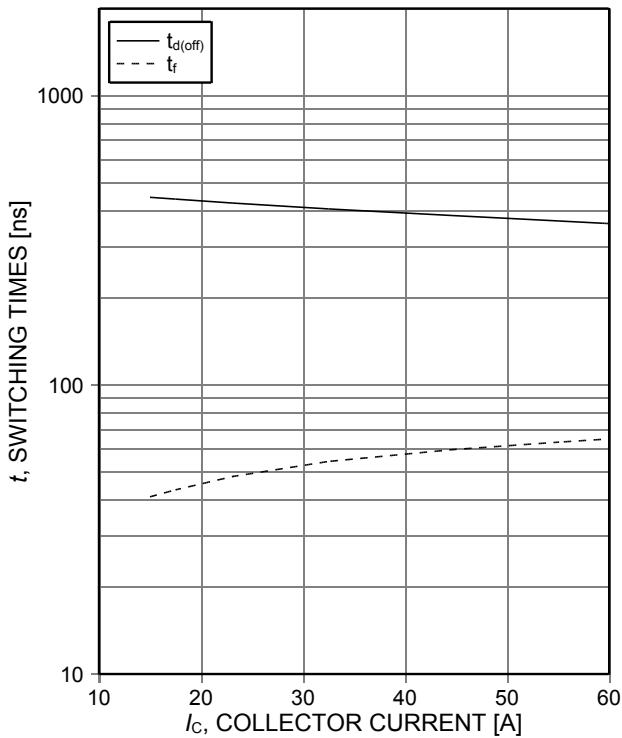

Figure 9. **Typical switching times as a function of collector current**  
 (ind. load,  $T_J=175^\circ\text{C}$ ,  $V_{CE}=600\text{V}$ ,  $V_{GE}=0/15\text{V}$ ,  $R_{G(on)}=15\Omega$ ,  $R_{G(off)}=15\Omega$ , test circuit in Fig. E)

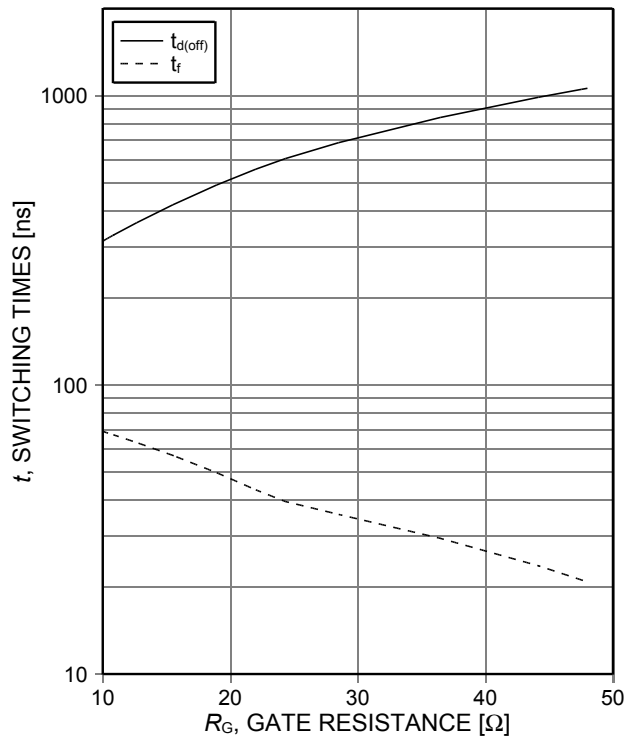

Figure 10. **Typical switching times as a function of gate resistance**  
 (ind. load,  $T_J=175^\circ\text{C}$ ,  $V_{CE}=600\text{V}$ ,  $V_{GE}=0/15\text{V}$ ,  $I_C=30\text{A}$ , test circuit in Fig. E)

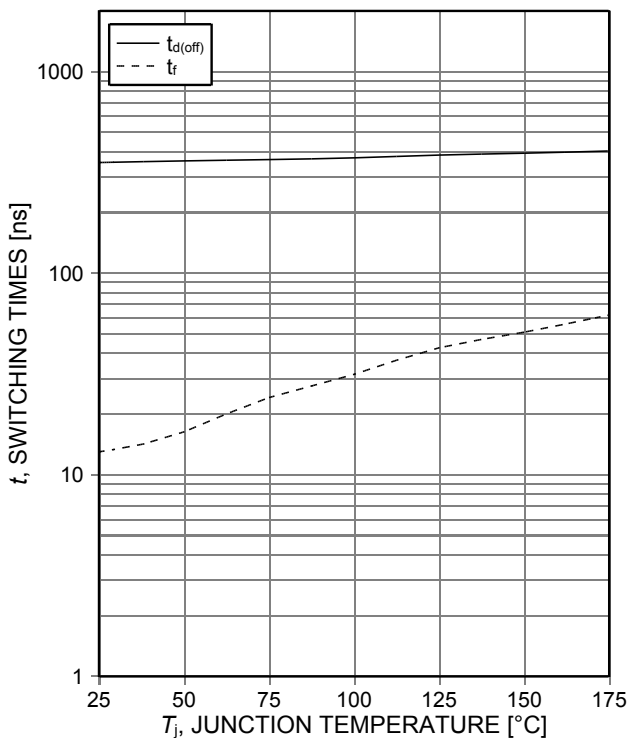

Figure 11. **Typical switching times as a function of junction temperature**  
 (ind. load,  $V_{CE}=600\text{V}$ ,  $V_{GE}=0/15\text{V}$ ,  $I_C=30\text{A}$ ,  $R_{G(on)}=15\Omega$ ,  $R_{G(off)}=15\Omega$ , test circuit in Fig. E)

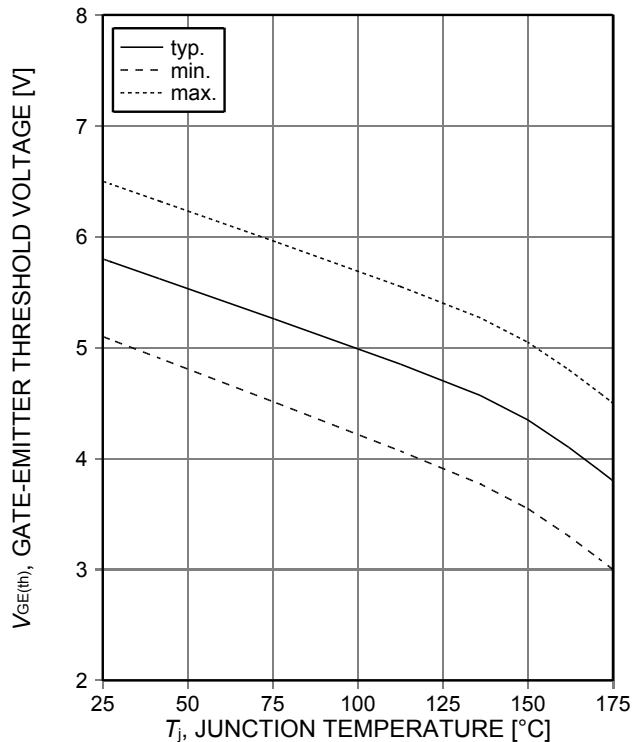

Figure 12. **Gate-emitter threshold voltage as a function of junction temperature**  
 ( $I_C=0.7\text{mA}$ )

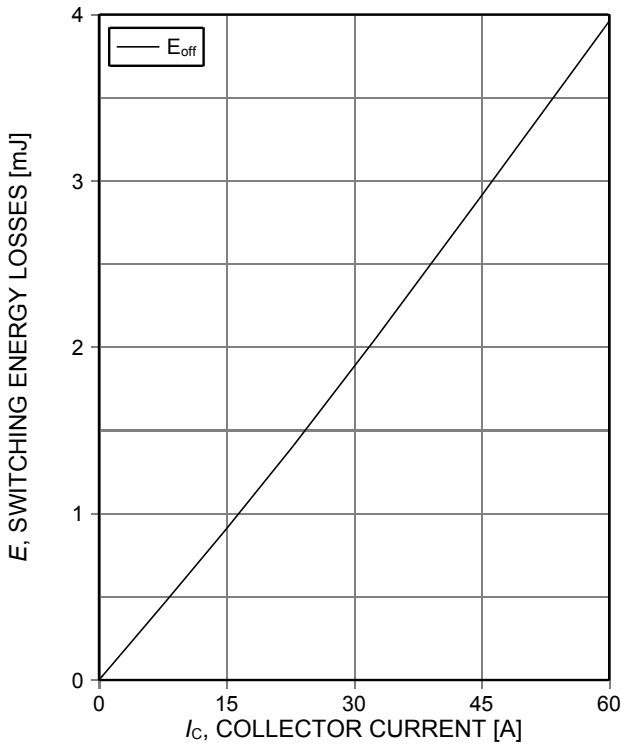

Figure 13. **Typical switching energy losses as a function of collector current**  
 (ind. load,  $T_j=175^\circ\text{C}$ ,  $V_{CE}=600\text{V}$ ,  $V_{GE}=0/15\text{V}$ ,  $R_{G(on)}=15\Omega$ ,  $R_{G(off)}=15\Omega$ , test circuit in Fig. E)

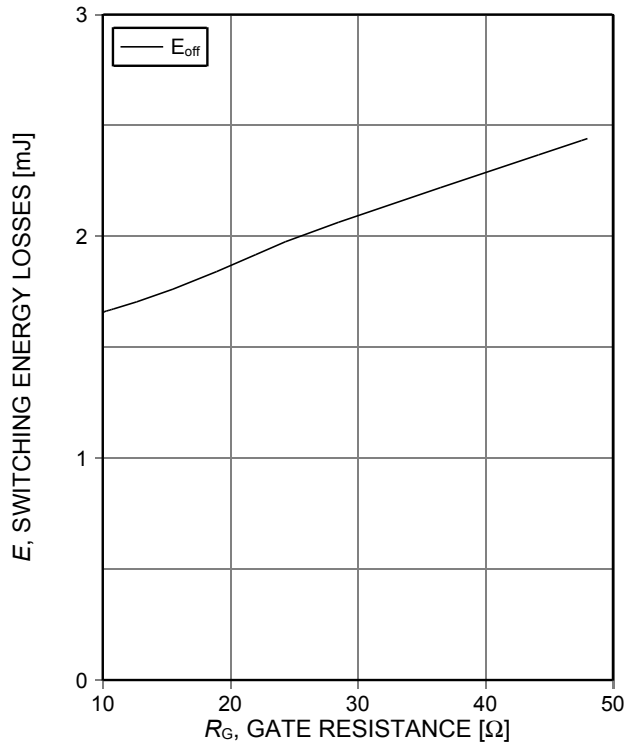

Figure 14. **Typical switching energy losses as a function of gate resistance**  
 (ind. load,  $T_j=175^\circ\text{C}$ ,  $V_{CE}=600\text{V}$ ,  $V_{GE}=0/15\text{V}$ , test circuit in Fig. E)

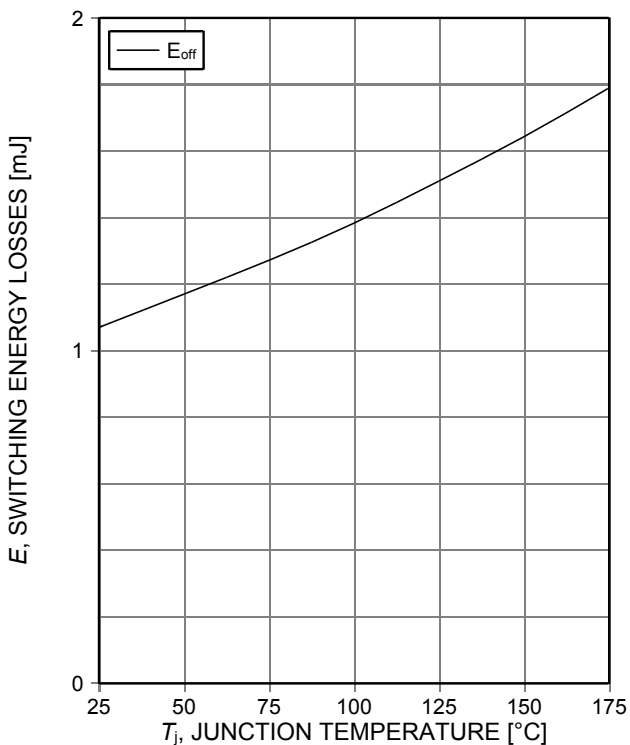

Figure 15. **Typical switching energy losses as a function of junction temperature**  
 (ind load,  $V_{CE}=600\text{V}$ ,  $V_{GE}=0/15\text{V}$ ,  $I_c=30\text{A}$ ,  $R_{G(on)}=15\Omega$ ,  $R_{G(off)}=15\Omega$ , test circuit in Fig. E)

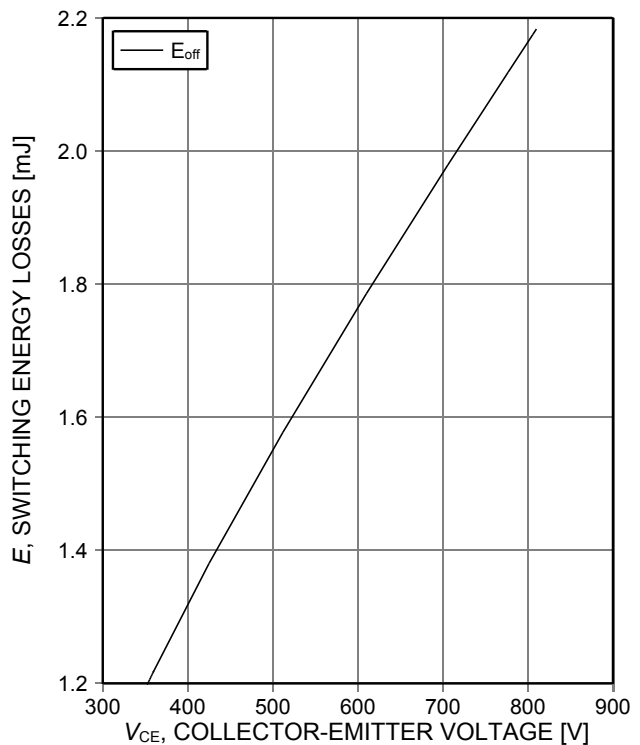

Figure 16. **Typical switching energy losses as a function of collector emitter voltage**  
 (ind. load,  $T_j=175^\circ\text{C}$ ,  $V_{GE}=0/15\text{V}$ ,  $I_c=30\text{A}$ ,  $R_{G(on)}=15\Omega$ ,  $R_{G(off)}=15\Omega$ , test circuit in Fig. E)

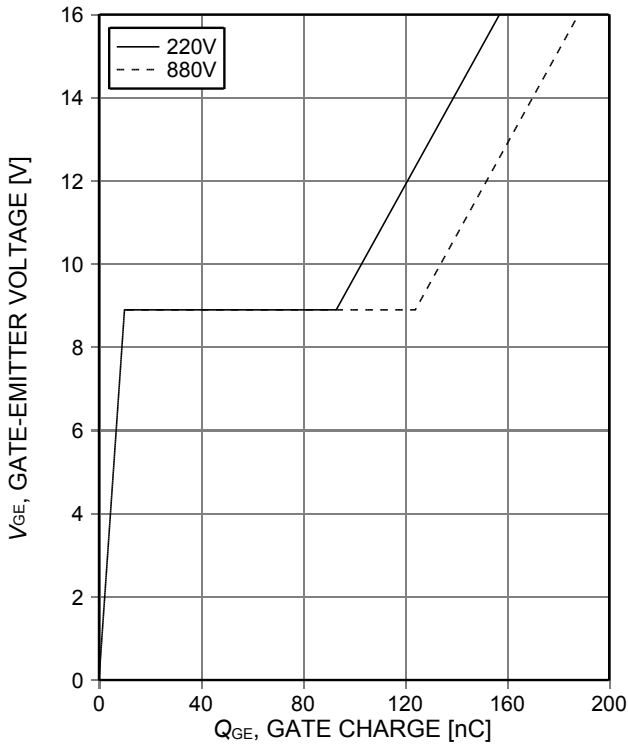

Figure 17. Typical gate charge ( $I_C=30A$ )

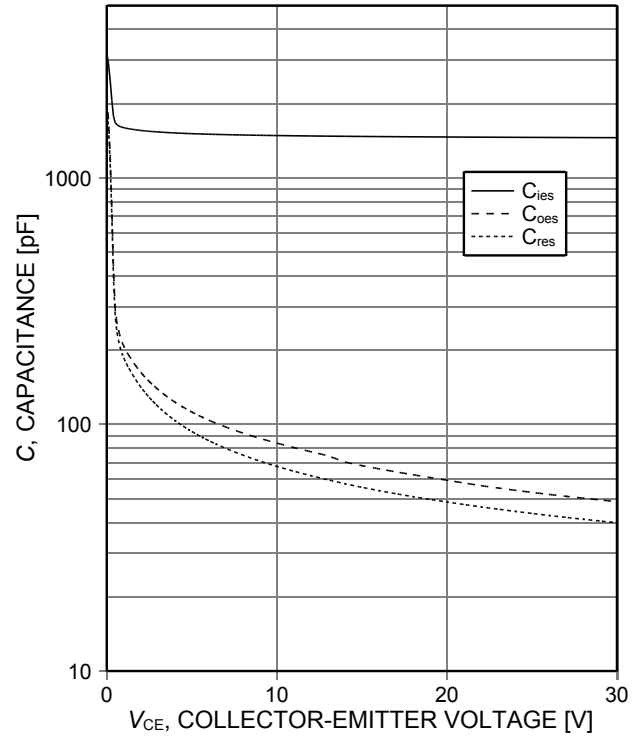

Figure 18. Typical capacitance as a function of collector-emitter voltage ( $V_{GE}=0V$ ,  $f=1MHz$ )

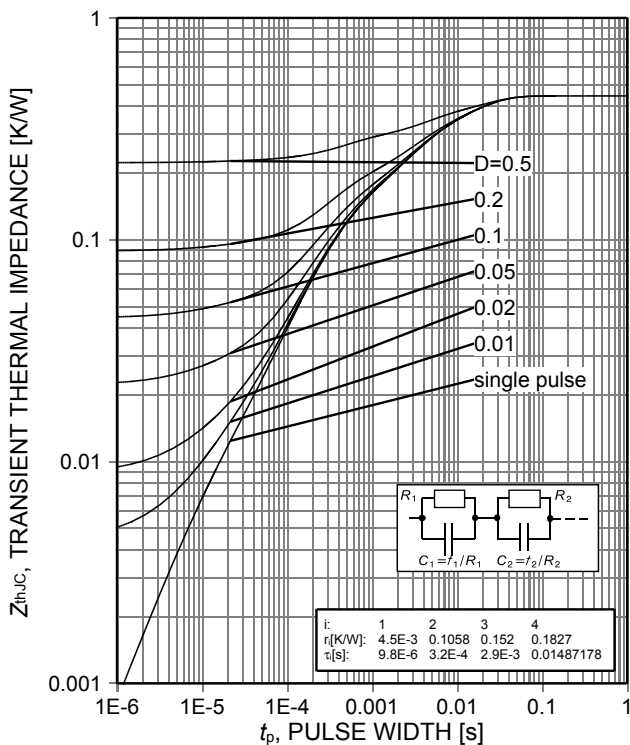

Figure 19. IGBT transient thermal impedance ( $D=t_p/T$ )

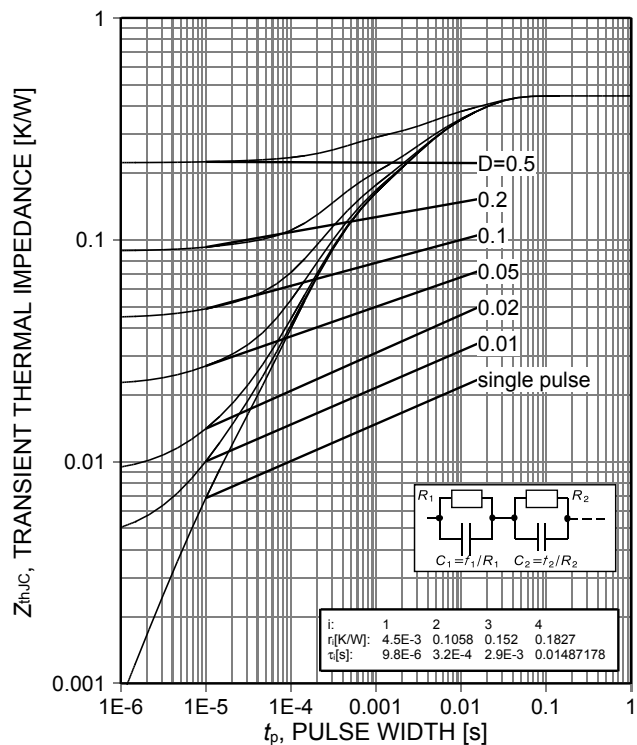

Figure 20. Diode transient thermal impedance as a function of pulse width ( $D=t_p/T$ )

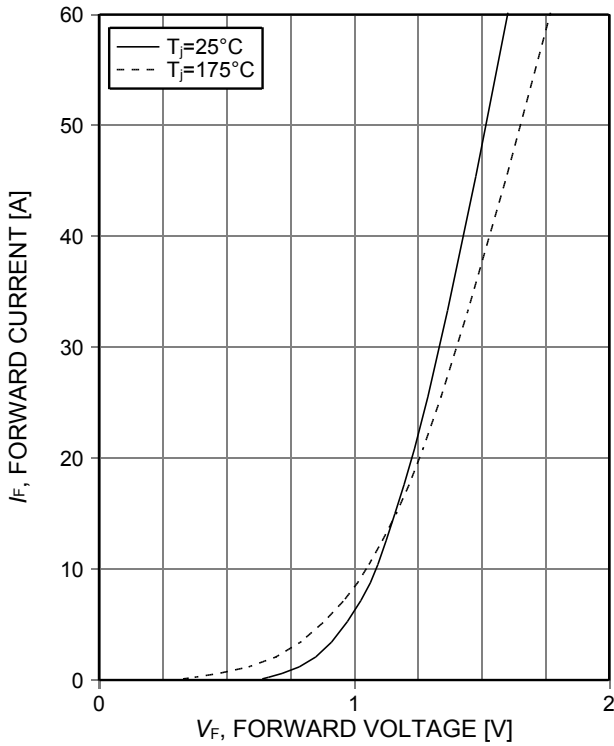

Figure 21. Typical diode forward current as a function of forward voltage

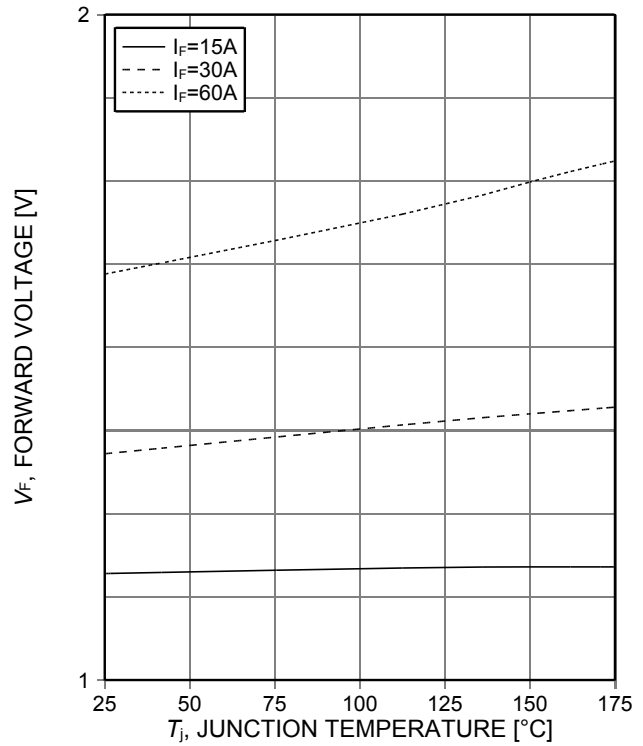

Figure 22. Typical diode forward voltage as a function of junction temperature

PG-TO247-3



| DIM | MILLIMETERS |       | INCHES      |       |
|-----|-------------|-------|-------------|-------|
|     | MIN         | MAX   | MIN         | MAX   |
| A   | 4.83        | 5.21  | 0.190       | 0.205 |
| A1  | 2.27        | 2.54  | 0.089       | 0.100 |
| A2  | 1.85        | 2.16  | 0.073       | 0.085 |
| b   | 1.07        | 1.33  | 0.042       | 0.052 |
| b1  | 1.90        | 2.41  | 0.075       | 0.095 |
| b2  | 1.90        | 2.16  | 0.075       | 0.085 |
| b3  | 2.87        | 3.38  | 0.113       | 0.133 |
| b4  | 2.87        | 3.13  | 0.113       | 0.123 |
| c   | 0.55        | 0.68  | 0.022       | 0.027 |
| D   | 20.80       | 21.10 | 0.819       | 0.831 |
| D1  | 16.25       | 17.65 | 0.640       | 0.695 |
| D2  | 0.95        | 1.35  | 0.037       | 0.053 |
| E   | 15.70       | 16.13 | 0.618       | 0.635 |
| E1  | 13.10       | 14.15 | 0.516       | 0.557 |
| E2  | 3.68        | 5.10  | 0.145       | 0.201 |
| E3  | 1.00        | 2.60  | 0.039       | 0.102 |
| e   | 5.44 (BSC)  |       | 0.214 (BSC) |       |
| N   | 3           |       | 3           |       |
| L   | 19.80       | 20.32 | 0.780       | 0.800 |
| L1  | 4.10        | 4.47  | 0.161       | 0.176 |
| øP  | 3.50        | 3.70  | 0.138       | 0.146 |
| Q   | 5.49        | 6.00  | 0.216       | 0.236 |
| S   | 6.04        | 6.30  | 0.238       | 0.248 |

DOCUMENT NO.  
Z8B00003327

SCALE  
0 5 5 7.5mm

EUROPEAN PROJECTION

ISSUE DATE  
09-07-2010

REVISION  
05

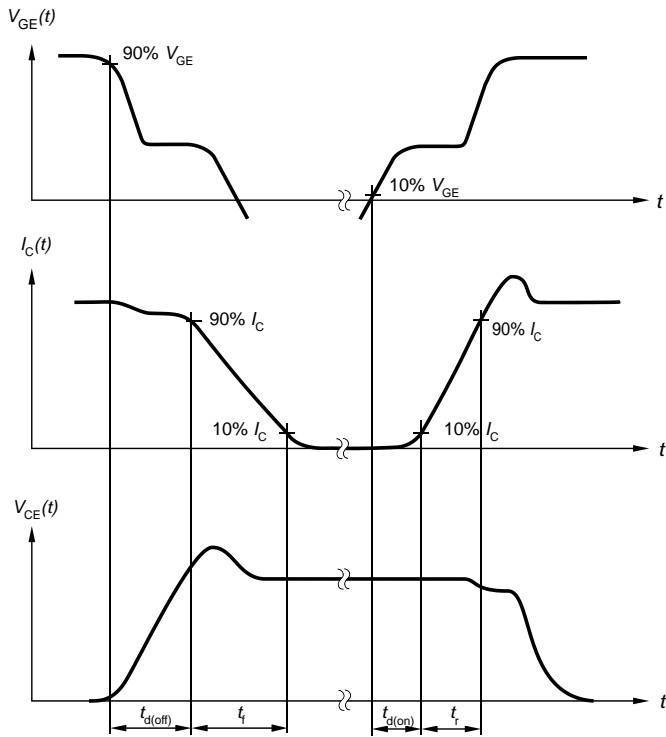

Figure A. Definition of switching times

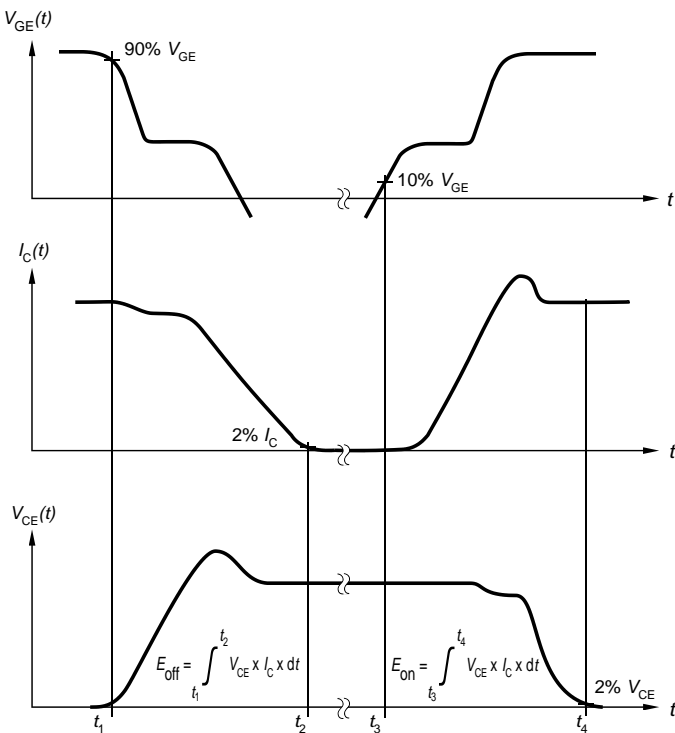

Figure B. Definition of switching losses

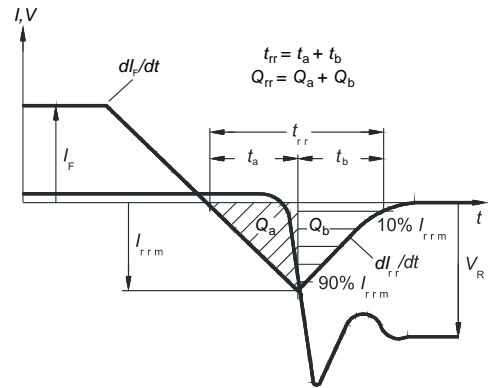

Figure C. Definition of diode switching characteristics

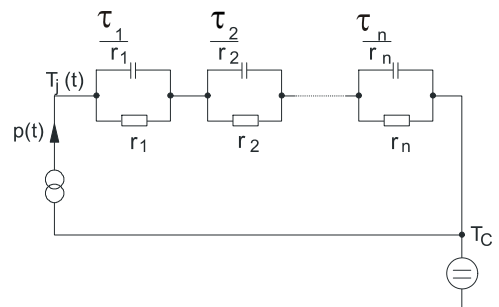

Figure D. Thermal equivalent circuit

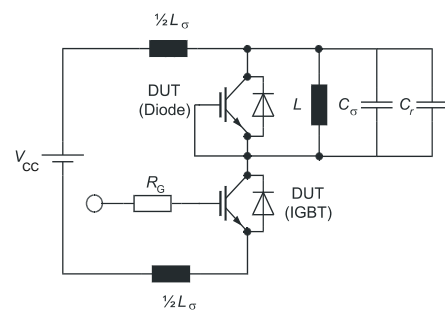

Figure E. Dynamic test circuit  
Parasitic inductance  $L_\sigma$ ,  
parasitic capacitor  $C_\sigma$ ,  
relief capacitor  $C_r$ ,  
(only for ZVT switching)

## Revision History

IHW30N110R3

Revision: 2015-01-26, Rev. 2.1

## Previous Revision

| Revision | Date       | Subjects (major changes since last revision) |
|----------|------------|--|
| 1.1      | 2009-12-01 | -  |
| 1.2      | 2011-01-21 | Package drawing Rev. 05                      |
| 1.3      | 2013-02-12 | Layout change                                |
| 2.1      | 2015-01-26 | Final data sheet                             |

## We Listen to Your Comments

Any information within this document that you feel is wrong, unclear or missing at all?

Your feedback will help us to continuously improve the quality of this document.

Please send your proposal (including a reference to this document) to: [erratum@infineon.com](mailto:erratum@infineon.com)

## Published by

Infineon Technologies AG

81726 Munich, Germany

81726 München, Germany

© 2015 Infineon Technologies AG

All Rights Reserved.

## Legal Disclaimer

The information given in this document shall in no event be regarded as a guarantee of conditions or characteristics.

With respect to any examples or hints given herein, any typical values stated herein and/or any information regarding the application of the device, Infineon Technologies hereby disclaims any and all warranties and liabilities of any kind, including without limitation, warranties of non-infringement of intellectual property rights of any third party.

## Information

For further information on technology, delivery terms and conditions and prices, please contact the nearest Infineon Technologies Office ([www.infineon.com](http://www.infineon.com)).

## Warnings

Due to technical requirements, components may contain dangerous substances. For information on the types in question, please contact the nearest Infineon Technologies Office.

The Infineon Technologies component described in this Data Sheet may be used in life-support devices or systems and/or automotive, aviation and aerospace applications or systems only with the express written approval of Infineon Technologies, if a failure of such components can reasonably be expected to cause the failure of that life-support, automotive, aviation and aerospace device or system or to affect the safety or effectiveness of that device or system. Life support devices or systems are intended to be implanted in the human body or to support and/or maintain and sustain and/or protect human life. If they fail, it is reasonable to assume that the health of the user or other persons may be endangered.

# Mouser Electronics

Authorized Distributor

Click to View Pricing, Inventory, Delivery & Lifecycle Information:

[Infineon:](#)

[IHW30N110R3](#)