

PDP SWITCH

IRFP4332PbF

Features

- Advanced Process Technology
- Key Parameters Optimized for PDP Sustain, Energy Recovery and Pass Switch Applications
- Low E_{PULSE} Rating to Reduce Power Dissipation in PDP Sustain, Energy Recovery and Pass Switch Applications
- Low Q_G for Fast Response
- High Repetitive Peak Current Capability for Reliable Operation
- Short Fall & Rise Times for Fast Switching
- 175°C Operating Junction Temperature for Improved Ruggedness
- Repetitive Avalanche Capability for Robustness and Reliability

Key Parameters		
$V_{DS\ min}$	250	V
$V_{DS\ (Avalanche)\ typ.}$	300	V
$R_{DS(ON)\ typ.\ @\ 10V}$	29	mΩ
$T_J\ max$	175	°C

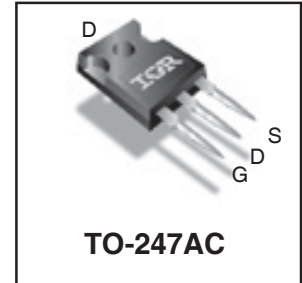
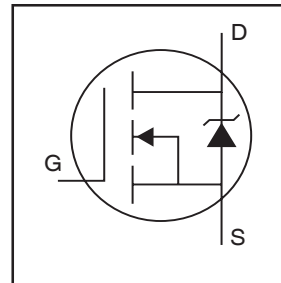

G	D	S
Gate	Drain	Source

Description

This HEXFET® Power MOSFET is specifically designed for Sustain; Energy Recovery & Pass switch applications in Plasma Display Panels. This MOSFET utilizes the latest processing techniques to achieve low on-resistance per silicon area and low E_{PULSE} rating. Additional features of this MOSFET are 175°C operating junction temperature and high repetitive peak current capability. These features combine to make this MOSFET a highly efficient, robust and reliable device for PDP driving applications.

Absolute Maximum Ratings

	Parameter	Max.	Units
V_{GS}	Gate-to-Source Voltage	±30	V
$I_D @ T_C = 25^\circ C$	Continuous Drain Current, $V_{GS} @ 10V$	57	A
$I_D @ T_C = 100^\circ C$	Continuous Drain Current, $V_{GS} @ 10V$	40	
I_{DM}	Pulsed Drain Current ①	230	
$I_{RP} @ T_C = 100^\circ C$	Repetitive Peak Current ⑤⑥	120	
$P_D @ T_C = 25^\circ C$	Power Dissipation	360	W
$P_D @ T_C = 100^\circ C$	Power Dissipation	180	
	Linear Derating Factor	2.4	W/°C
T_J T_{STG}	Operating Junction and Storage Temperature Range	-40 to + 175	°C
	Soldering Temperature for 10 seconds	300	
	Mounting Torque, 6-32 or M3 Screw	10lb·in (1.1N·m)	

Thermal Resistance

	Parameter	Typ.	Max.	Units
$R_{\theta JC}$	Junction-to-Case ④	—	0.42	°C/W
$R_{\theta CS}$	Case-to-Sink, Flat, Greased Surface	0.24	—	
$R_{\theta JA}$	Junction-to-Ambient -	—	40	

Notes ① through ⑥ are on page 9

Electrical Characteristics @ $T_J = 25^\circ\text{C}$ (unless otherwise specified)

	Parameter	Min.	Typ.	Max.	Units	Conditions
BV_{DSS}	Drain-to-Source Breakdown Voltage	250	—	—	V	$V_{GS} = 0V, I_D = 250\mu A$
$\Delta BV_{DSS}/\Delta T_J$	Breakdown Voltage Temp. Coefficient	—	170	—	mV/°C	Reference to $25^\circ\text{C}, I_D = 1\text{mA}$
$R_{DS(on)}$	Static Drain-to-Source On-Resistance	—	29	33	mΩ	$V_{GS} = 10V, I_D = 35A$ ③
$V_{GS(th)}$	Gate Threshold Voltage	3.0	—	5.0	V	$V_{DS} = V_{GS}, I_D = 250\mu A$
$\Delta V_{GS(th)}/\Delta T_J$	Gate Threshold Voltage Coefficient	—	-14	—	mV/°C	
I_{DSS}	Drain-to-Source Leakage Current	—	—	20	μA	$V_{DS} = 250V, V_{GS} = 0V$
		—	—	200	μA	$V_{DS} = 250V, V_{GS} = 0V, T_J = 125^\circ\text{C}$
I_{GSS}	Gate-to-Source Forward Leakage	—	—	100	nA	$V_{GS} = 20V$
	Gate-to-Source Reverse Leakage	—	—	-100	nA	$V_{GS} = -20V$
g_{fs}	Forward Transconductance	100	—	—	S	$V_{DS} = 25V, I_D = 35A$
Q_g	Total Gate Charge	—	99	150	nC	$V_{DD} = 125V, I_D = 35A, V_{GS} = 10V$ ③
Q_{gd}	Gate-to-Drain Charge	—	35	—	nC	
t_{st}	Shoot Through Blocking Time	100	—	—	ns	$V_{DD} = 200V, V_{GS} = 15V, R_G = 4.7\Omega$
E_{PULSE}	Energy per Pulse	—	520	—	μJ	$L = 220\text{nH}, C = 0.3\mu F, V_{GS} = 15V$ $V_{DS} = 200V, R_G = 5.1\Omega, T_J = 25^\circ\text{C}$
		—	920	—	μJ	$L = 220\text{nH}, C = 0.3\mu F, V_{GS} = 15V$ $V_{DS} = 200V, R_G = 5.1\Omega, T_J = 100^\circ\text{C}$
C_{iss}	Input Capacitance	—	5860	—	pF	$V_{GS} = 0V$
C_{oss}	Output Capacitance	—	530	—	pF	$V_{DS} = 25V$
C_{rss}	Reverse Transfer Capacitance	—	130	—	pF	$f = 1.0\text{MHz},$
$C_{oss\ eff.}$	Effective Output Capacitance	—	360	—	pF	$V_{GS} = 0V, V_{DS} = 0V \text{ to } 200V$
L_D	Internal Drain Inductance	—	5.0	—	nH	Between lead, 6mm (0.25in.) from package and center of die contact
L_S	Internal Source Inductance	—	13	—	nH	

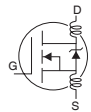

Avalanche Characteristics

	Parameter	Typ.	Max.	Units
E_{AS}	Single Pulse Avalanche Energy ②	—	210	mJ
E_{AR}	Repetitive Avalanche Energy ①	—	36	mJ
$V_{DS(Avalanche)}$	Repetitive Avalanche Voltage ①	300	—	V
I_{AS}	Avalanche Current ②	—	35	A

Diode Characteristics

	Parameter	Min.	Typ.	Max.	Units	Conditions
$I_S @ T_C = 25^\circ\text{C}$	Continuous Source Current (Body Diode)	—	—	57	A	MOSFET symbol showing the integral reverse p-n junction diode.
I_{SM}	Pulsed Source Current (Body Diode) ①	—	—	230	A	
V_{SD}	Diode Forward Voltage	—	—	1.3	V	$T_J = 25^\circ\text{C}, I_S = 35A, V_{GS} = 0V$ ③
t_{rr}	Reverse Recovery Time	—	190	290	ns	$T_J = 25^\circ\text{C}, I_F = 35A, V_{DD} = 50V$
Q_{rr}	Reverse Recovery Charge	—	820	1230	nC	$di/dt = 100A/\mu s$ ③

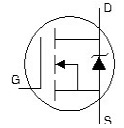

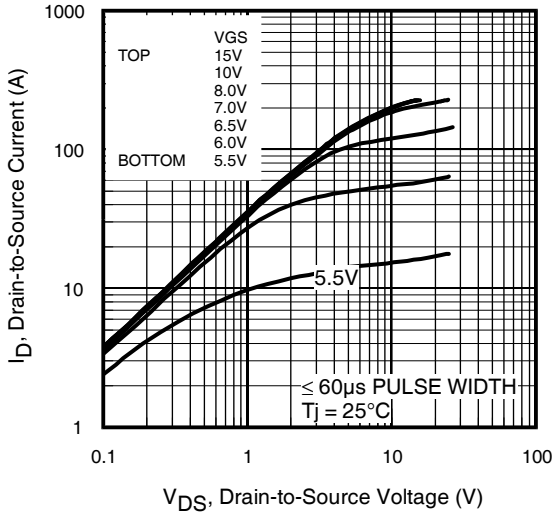

Fig 1. Typical Output Characteristics

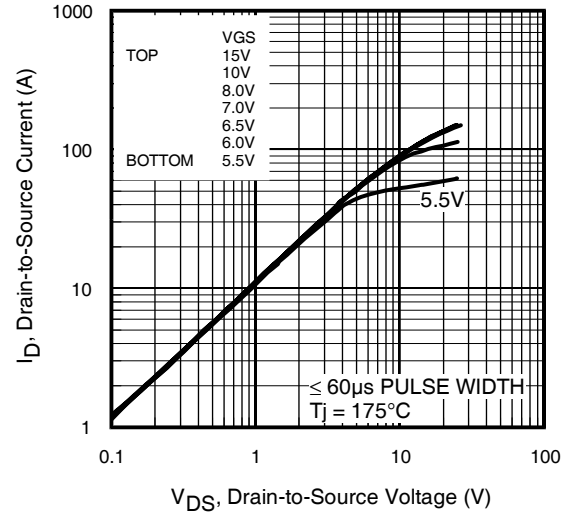

Fig 2. Typical Output Characteristics

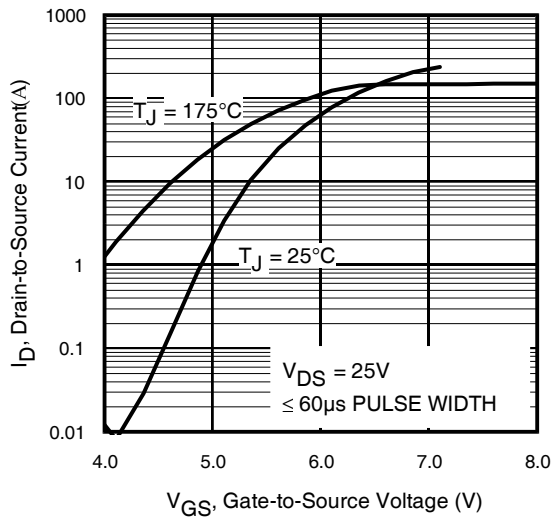

Fig 3. Typical Transfer Characteristics

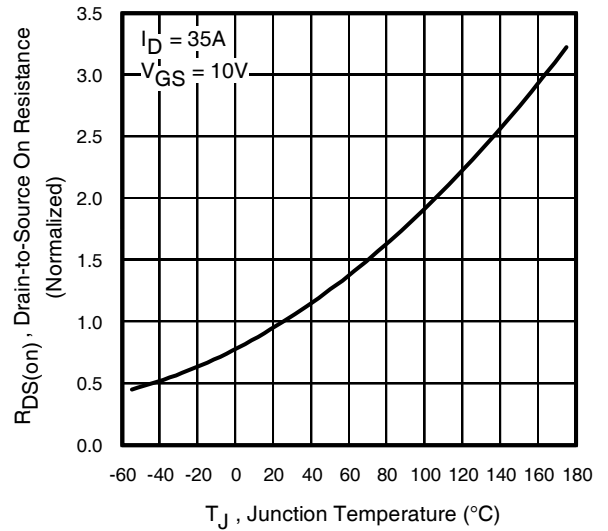

Fig 4. Normalized On-Resistance vs. Temperature

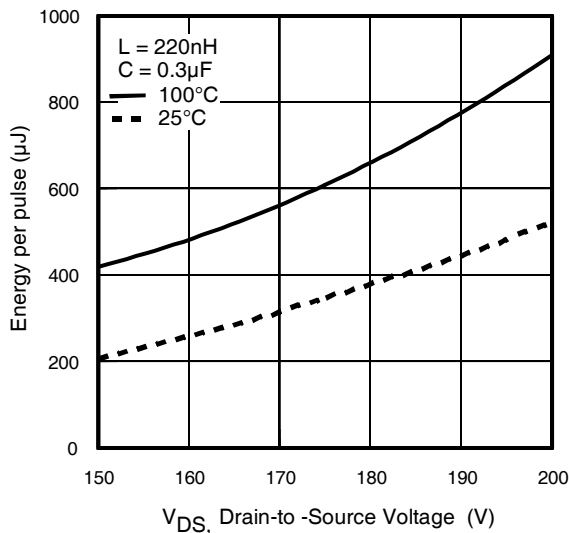

Fig 5. Typical E_{PULSE} vs. Drain-to-Source Voltage

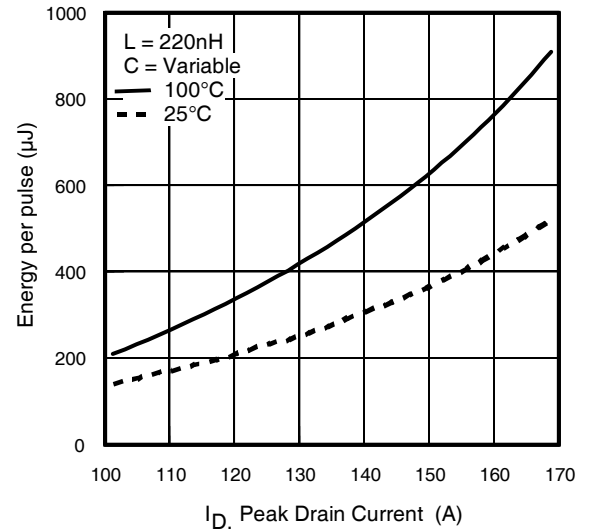

Fig 6. Typical E_{PULSE} vs. Drain Current

IRFP4332PbF

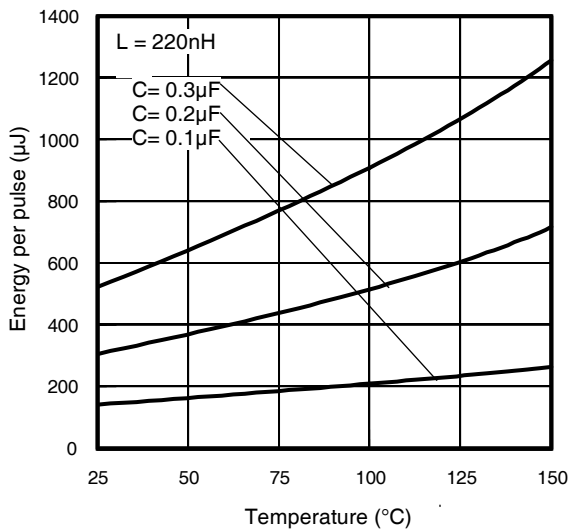

Fig 7. Typical E_{PULSE} vs. Temperature

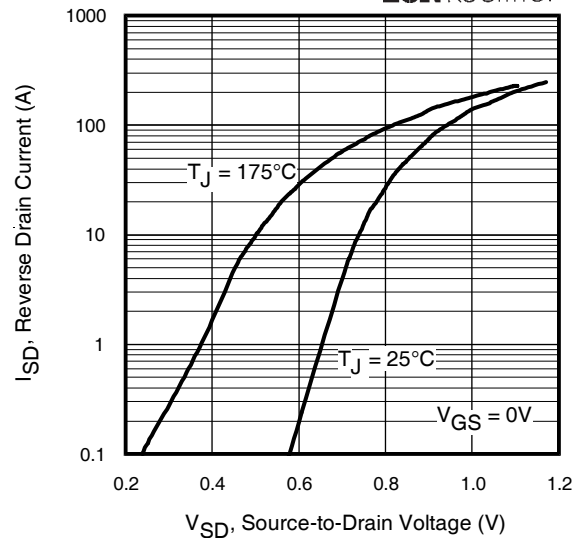

Fig 8. Typical Source-Drain Diode Forward Voltage

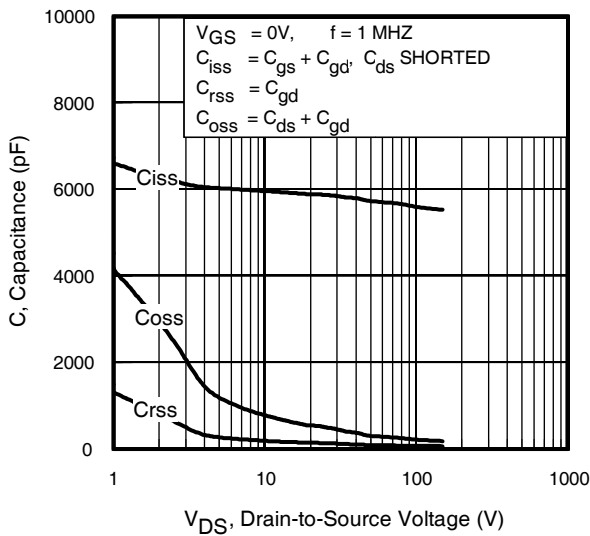

Fig 9. Typical Capacitance vs. Drain-to-Source Voltage

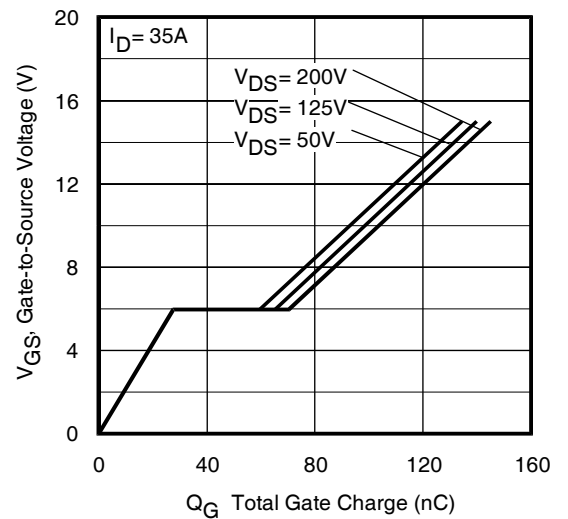

Fig 10. Typical Gate Charge vs. Gate-to-Source Voltage

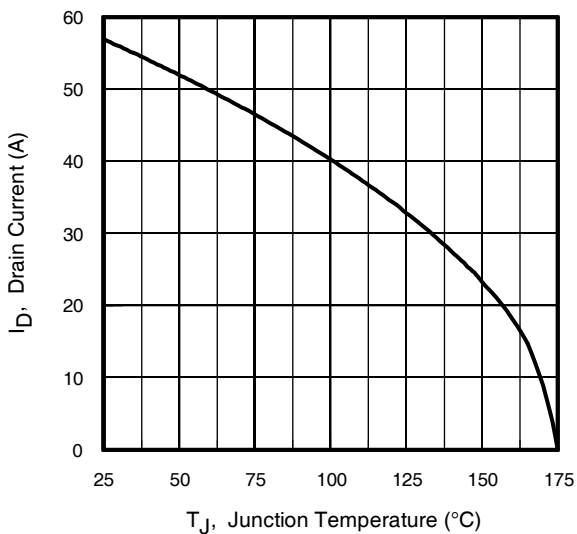

Fig 11. Maximum Drain Current vs. Case Temperature

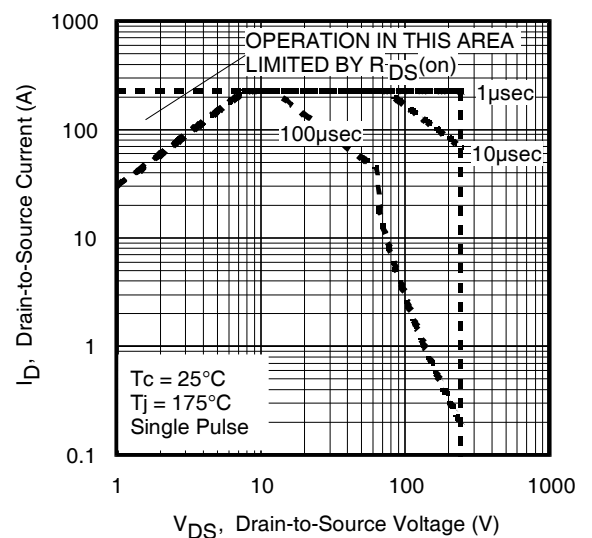

Fig 12. Maximum Safe Operating Area

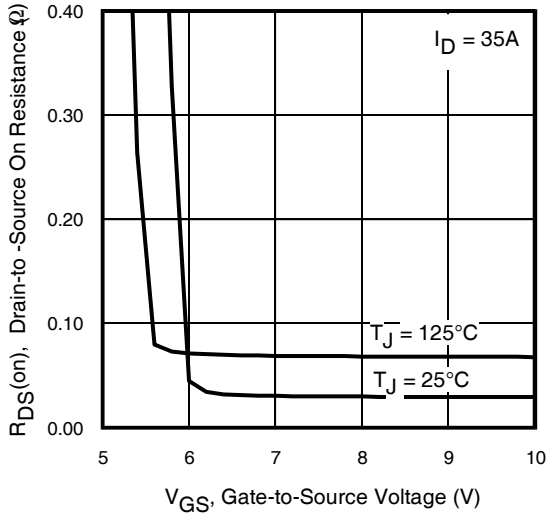

Fig 13. On-Resistance Vs. Gate Voltage

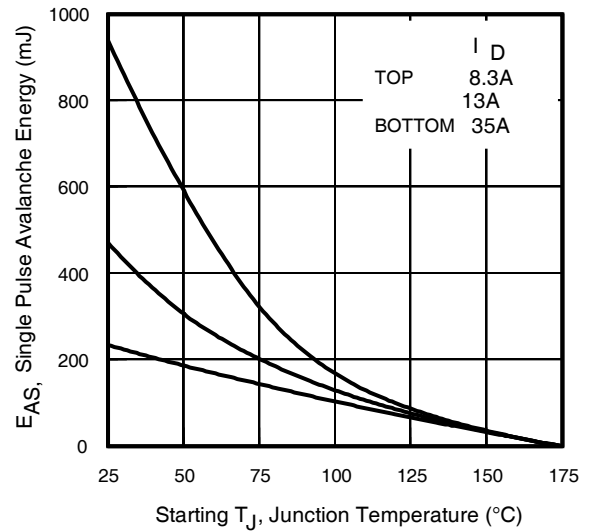

Fig 14. Maximum Avalanche Energy Vs. Temperature

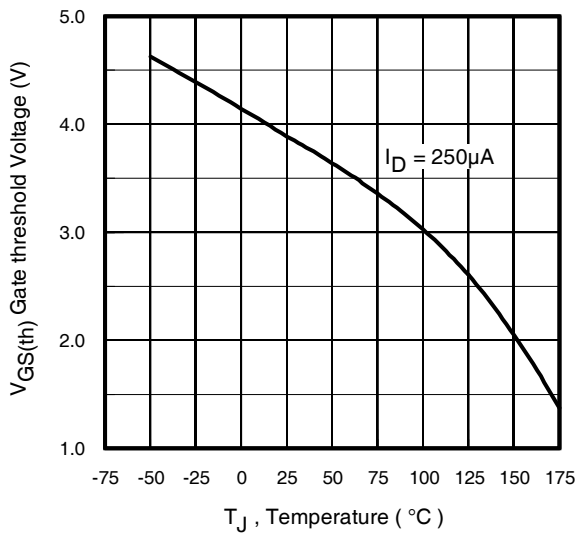

Fig 15. Threshold Voltage vs. Temperature

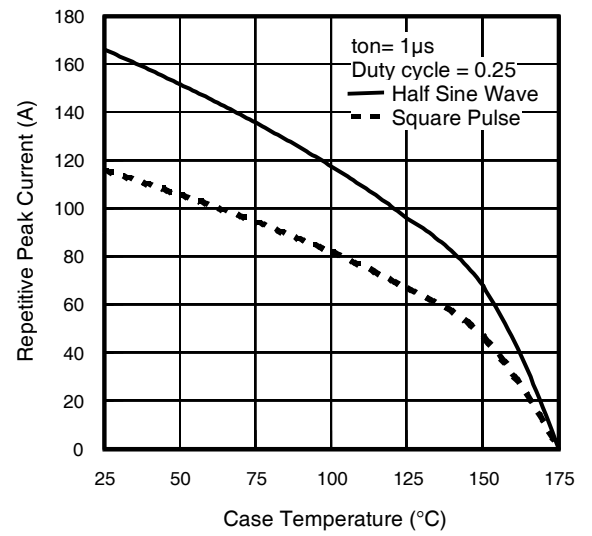

Fig 16. Typical Repetitive peak Current vs. Case temperature

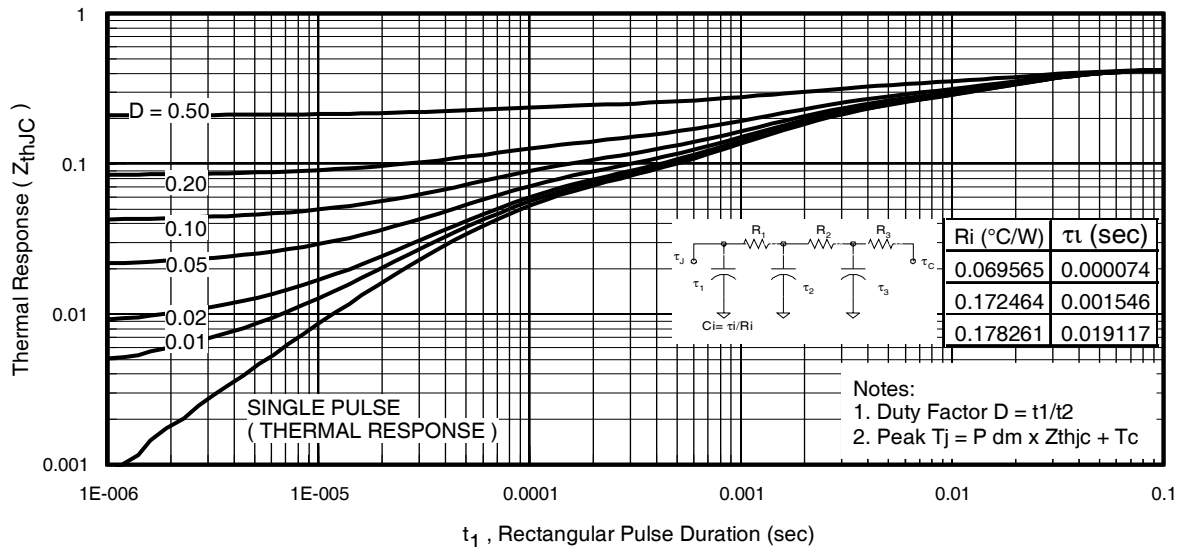

Fig 17. Maximum Effective Transient Thermal Impedance, Junction-to-Case

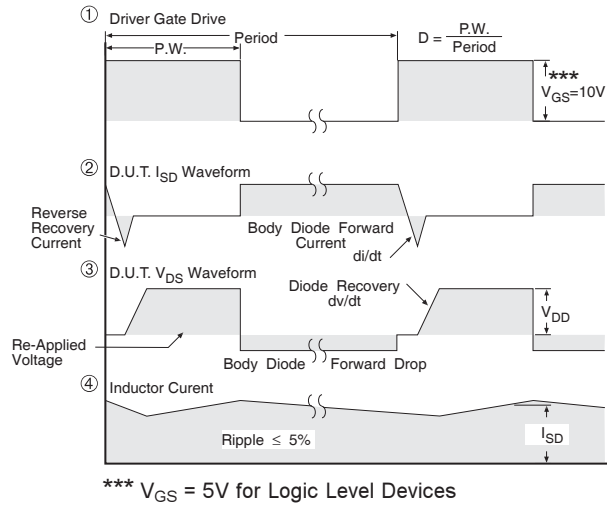

Fig 18. Diode Reverse Recovery Test Circuit for HEXFET® Power MOSFETs



Fig 19a. Unclamped Inductive Test Circuit

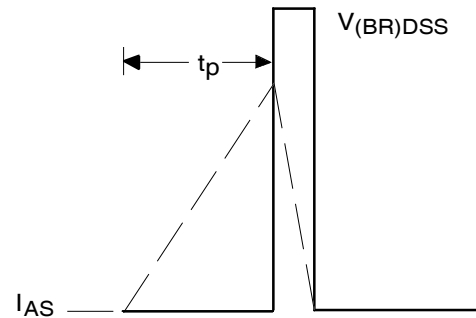

Fig 19b. Unclamped Inductive Waveforms

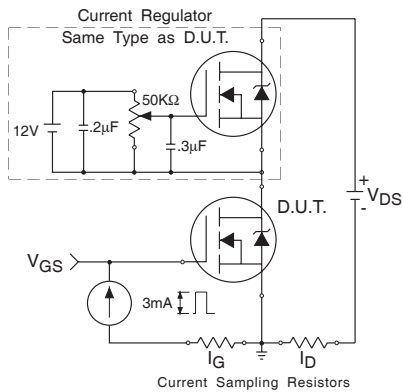

Fig 20a. Gate Charge Test Circuit



Fig 20b. Gate Charge Waveform

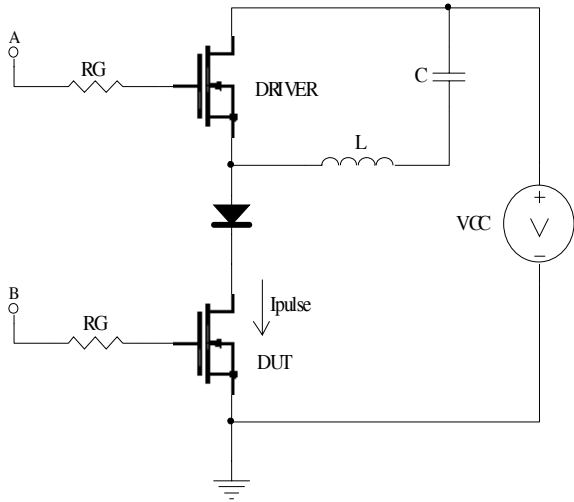

Fig 21a. t_{st} and E_{PULSE} Test Circuit

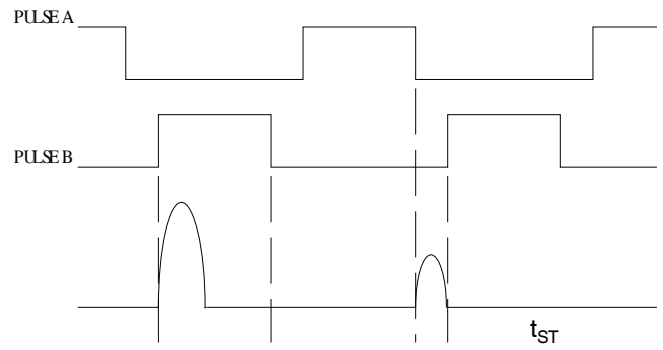

Fig 21b. t_{st} Test Waveforms

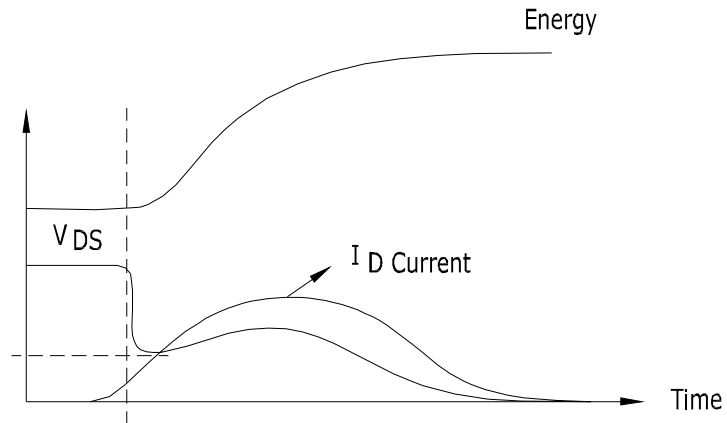
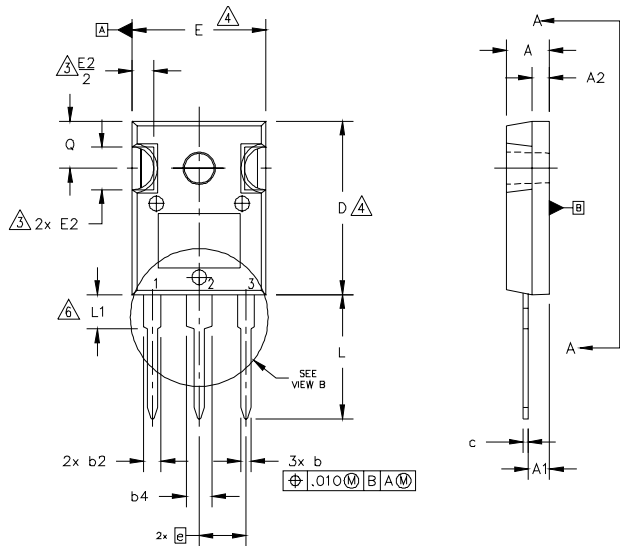

Fig 21c. E_{PULSE} Test Waveforms

IRFP4332PbF

TO-247AC Package Outline Dimensions are shown in millimeters (inches)



NOTES:

1. DIMENSIONING AND TOLERANCING AS PER ASME Y14.5M 1994.
2. DIMENSIONS ARE SHOWN IN INCHES.
3. CONTOUR OF SLOT OPTIONAL.
4. DIMENSION D & E DO NOT INCLUDE MOLD FLASH. MOLD FLASH SHALL NOT EXCEED .005" (0.127) PER SIDE. THESE DIMENSIONS ARE MEASURED AT THE OUTERMOST EXTREMES OF THE PLASTIC BODY.
5. THERMAL PAD CONTOUR OPTIONAL WITHIN DIMENSIONS D1 & E1.
6. LEAD FINISH UNCONTROLLED IN L1.
7. ØP TO HAVE A MAXIMUM DRAFT ANGLE OF 1.5 ° TO THE TOP OF THE PART WITH A MAXIMUM HOLE DIAMETER OF .154 INCH.
8. OUTLINE CONFORMS TO JEDEC OUTLINE TO-247AC .

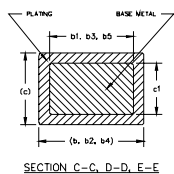
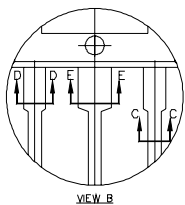
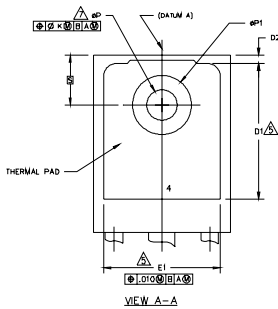
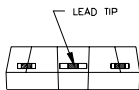

SYMBOL	DIMENSIONS				NOTES
	INCHES		MILLIMETERS		
	MIN.	MAX.	MIN.	MAX.	
A	.183	.209	4.65	5.31	
A1	.087	.102	2.21	2.59	
A2	.059	.098	1.50	2.49	
b	.039	.056	0.99	1.40	
b1	.039	.053	0.99	1.35	
b2	.065	.094	1.65	2.39	
b3	.065	.092	1.65	2.34	
b4	.102	.135	2.59	3.43	
b5	.102	.133	2.59	3.38	
c	.015	.035	0.38	0.89	
c1	.015	.033	0.38	0.84	
D	.776	.815	19.71	20.70	4
D1	.515	-	13.08	-	5
D2	.020	.053	0.51	1.35	
E	.602	.625	15.29	15.87	4
E1	.530	-	13.46	-	
E2	.178	.216	4.52	5.49	
e	.215 BSC		5.46 BSC		
Øk	.010		0.25		
L	.559	.634	14.20	16.10	
L1	.146	.169	3.71	4.29	
ØP	.140	.144	3.56	3.66	
ØP1	-	.291	-	7.39	
Q	.209	.224	5.31	5.69	
S	.217 BSC		5.51 BSC		

LEAD ASSIGNMENTS

HEXFET

- 1.- GATE
- 2.- DRAIN
- 3.- SOURCE
- 4.- DRAIN

IGBTs, CoPACK

- 1.- GATE
- 2.- COLLECTOR
- 3.- EMITTER
- 4.- COLLECTOR

DIODES

- 1.- ANODE/OPEN
- 2.- CATHODE
- 3.- ANODE

TO-247AC package is not recommended for Surface Mount Application.

Note: For the most current drawing please refer to IR website at: <http://www.irf.com/package/>

TO-247AC Part Marking Information

EXAMPLE: THIS IS AN IRFPE30
 WITH ASSEMBLY
 LOT CODE 5657
 ASSEMBLED ON WW 35, 2001
 IN THE ASSEMBLY LINE "H"

Note: "P" in assembly line position
 indicates "Lead-Free"

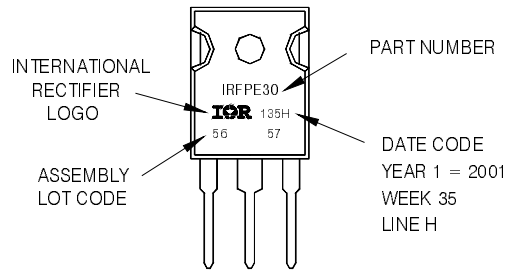

TO-247AC Lead Option- 203

All dimensions in millimeters (inches)

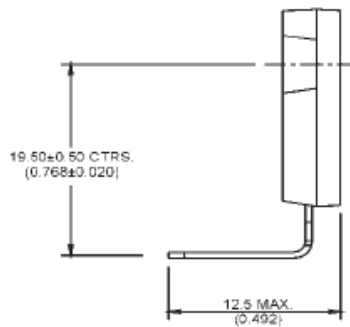
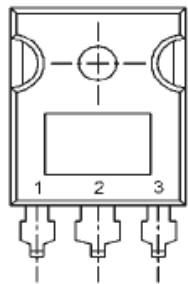

Lead Assignments
 1- Gate
 2- Drain
 3- Source

Notes:

- ① Repetitive rating; pulse width limited by max. junction temperature.
- ② Starting $T_J = 25^\circ\text{C}$, $L = 0.35\text{mH}$, $R_G = 25\Omega$, $I_{AS} = 35\text{A}$.
- ③ Pulse width $\leq 400\mu\text{s}$; duty cycle $\leq 2\%$.
- ④ R_θ is measured at T_J of approximately 90°C .
- ⑤ Half sine wave with duty cycle = 0.25, $t_{on} = 1\mu\text{sec}$.
- ⑥ Applicable to Sustain and Energy Recovery applications.

Data and specifications subject to change without notice.
 This product has been designed and qualified for the Industrial market.
 Qualification Standards can be found on IR's Web site.

International
IR Rectifier

IR WORLD HEADQUARTERS: 233 Kansas St., El Segundo, California 90245, USA Tel: (310) 252-7105
 TAC Fax: (310) 252-7903

Visit us at www.irf.com for sales contact information. 12/2009

Mouser Electronics

Authorized Distributor

Click to View Pricing, Inventory, Delivery & Lifecycle Information:

[International Rectifier:](#)

[IRFP4332PBF](#)