

# IRLML9301TRPbF

HEXFET® Power MOSFET

$V_{DS}$	<b>-30</b>	<b>V</b>
$V_{GS\ Max}$	<b>± 20</b>	<b>V</b>
$R_{DS(on)\ max}$ (@ $V_{GS} = -10V$ )	<b>64</b>	<b>mΩ</b>
$R_{DS(on)\ max}$ (@ $V_{GS} = -4.5V$ )	<b>103</b>	<b>mΩ</b>

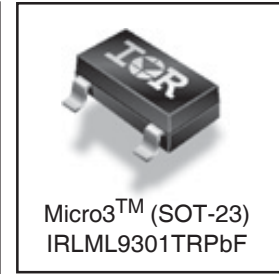
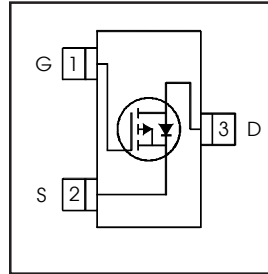

## Application(s)

- System/Load Switch

## Features and Benefits

### Features

Low $R_{DS(on)}$ ( $\leq 64m\Omega$ )
Industry-standard pinout
Compatible with existing Surface Mount Techniques
RoHS compliant containing no lead, no bromide and no halogen
MSL1, Consumer qualification

results in  
⇒

### Benefits

Lower switching losses
Multi-vendor compatibility
Easier manufacturing
Environmentally friendly
Increased reliability

Symbol	Parameter	Max.	Units
$V_{DS}$	Drain-Source Voltage	-30	V
$I_D @ T_A = 25^\circ C$	Continuous Drain Current, $V_{GS} @ 10V$	-3.6	A
$I_D @ T_A = 70^\circ C$	Continuous Drain Current, $V_{GS} @ 10V$	-2.9	
$I_{DM}$	Pulsed Drain Current	-15	
$P_D @ T_A = 25^\circ C$	Maximum Power Dissipation	1.3	W
$P_D @ T_A = 70^\circ C$	Maximum Power Dissipation	0.8	
	Linear Derating Factor	0.01	W/°C
$V_{GS}$	Gate-to-Source Voltage	± 20	V
$T_J, T_{STG}$	Junction and Storage Temperature Range	-55 to + 150	°C

## Thermal Resistance

Symbol	Parameter	Typ.	Max.	Units
$R_{\theta JA}$	Junction-to-Ambient ③	—	100	°C/W
$R_{\theta JA}$	Junction-to-Ambient ( $t < 10s$ ) ④	—	99	

## ORDERING INFORMATION:

See detailed ordering and shipping information on the last page of this data sheet.

Notes ① through ④ are on page 10  
www.irf.com

# IRLML9301TRPbF

International  
IR Rectifier

## Electric Characteristics @ $T_J = 25^\circ\text{C}$ (unless otherwise specified)

Symbol	Parameter	Min.	Typ.	Max.	Units	Conditions
$V_{(BR)DSS}$	Drain-to-Source Breakdown Voltage	-30	—	—	V	$V_{GS} = 0V, I_D = -250\mu A$
$\Delta V_{(BR)DSS}/\Delta T_J$	Breakdown Voltage Temp. Coefficient	—	0.02	—	V/°C	Reference to $25^\circ\text{C}$ , $I_D = -1\text{mA}$
$R_{DS(on)}$	Static Drain-to-Source On-Resistance	—	51	64	m $\Omega$	$V_{GS} = -10V, I_D = -3.6A$ ②
		—	82	103		$V_{GS} = -4.5V, I_D = -2.9A$ ②
$V_{GS(th)}$	Gate Threshold Voltage	-1.3	—	-2.4	V	$V_{DS} = V_{GS}, I_D = -10\mu A$
$I_{DSS}$	Drain-to-Source Leakage Current	—	—	1	$\mu A$	$V_{DS} = -24V, V_{GS} = 0V$
		—	—	150		$V_{DS} = -24V, V_{GS} = 0V, T_J = 125^\circ\text{C}$
$I_{GSS}$	Gate-to-Source Forward Leakage	—	—	-100	nA	$V_{GS} = -20V$
	Gate-to-Source Reverse Leakage	—	—	100		$V_{GS} = 20V$
$R_G$	Internal Gate Resistance	—	12	—	$\Omega$	
$g_{fs}$	Forward Transconductance	5.0	—	—	S	$V_{DS} = -10V, I_D = -3.6A$
$Q_g$	Total Gate Charge	—	4.8	—	nC	$I_D = -3.6A$
$Q_{gs}$	Gate-to-Source Charge	—	1.2	—		$V_{DS} = -15V$
$Q_{gd}$	Gate-to-Drain ("Miller") Charge	—	2.5	—		$V_{GS} = -4.5V$ ②
$t_{d(on)}$	Turn-On Delay Time	—	9.6	—	ns	$V_{DD} = -15V$ ②
$t_r$	Rise Time	—	19	—		$I_D = -1A$
$t_{d(off)}$	Turn-Off Delay Time	—	16	—		$R_G = 6.8\Omega$
$t_f$	Fall Time	—	15	—		$V_{GS} = -4.5V$
$C_{iss}$	Input Capacitance	—	388	—	pF	$V_{GS} = 0V$
$C_{oss}$	Output Capacitance	—	93	—		$V_{DS} = -25V$
$C_{rss}$	Reverse Transfer Capacitance	—	65	—		$f = 1.0\text{KHz}$

## Source - Drain Ratings and Characteristics

Symbol	Parameter	Min.	Typ.	Max.	Units	Conditions
$I_S$	Continuous Source Current (Body Diode)	—	—	-1.3	A	MOSFET symbol showing the integral reverse p-n junction diode.
$I_{SM}$	Pulsed Source Current (Body Diode) ①	—	—	-15		
$V_{SD}$	Diode Forward Voltage	—	—	-1.2	V	$T_J = 25^\circ\text{C}, I_S = -1.3A, V_{GS} = 0V$ ②
$t_{rr}$	Reverse Recovery Time	—	14	21	ns	$T_J = 25^\circ\text{C}, V_R = -24V, I_F = -1.3A$
$Q_{rr}$	Reverse Recovery Charge	—	7.2	11	nC	$di/dt = 100A/\mu s$ ②

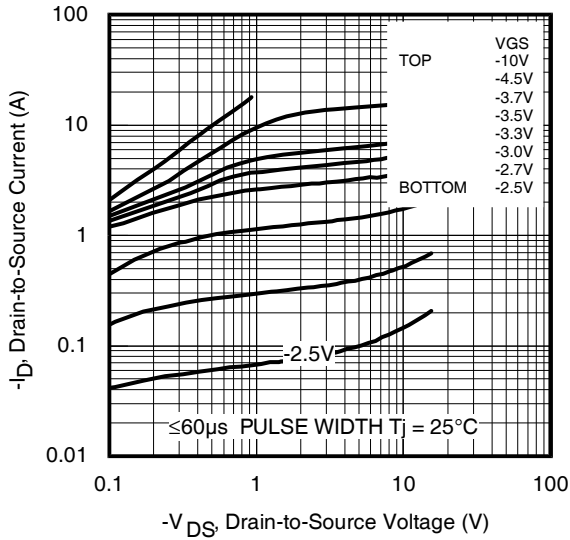

Fig 1. Typical Output Characteristics

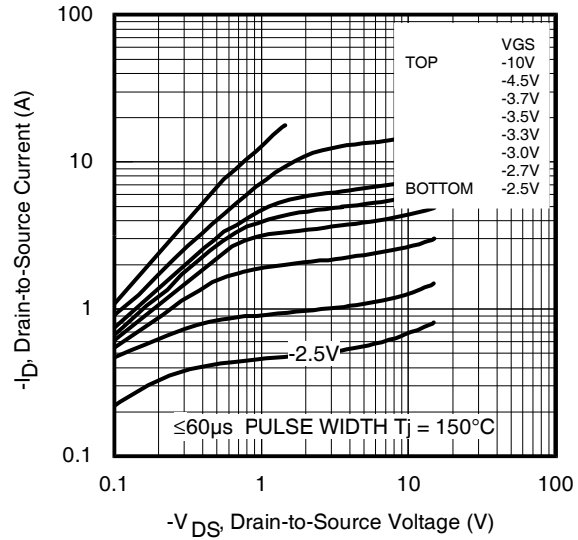

Fig 2. Typical Output Characteristics

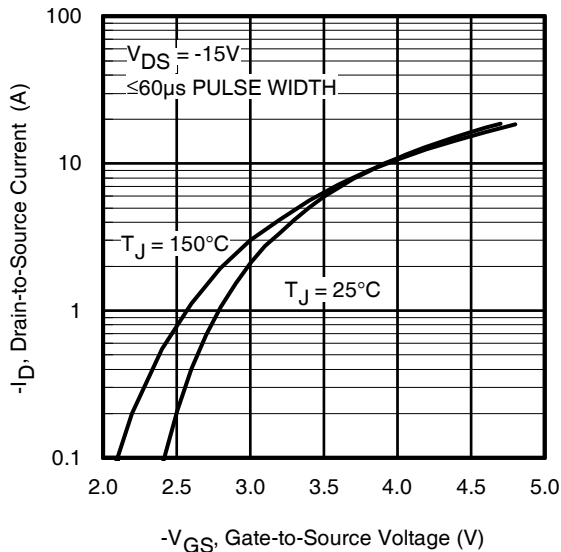

Fig 3. Typical Transfer Characteristics

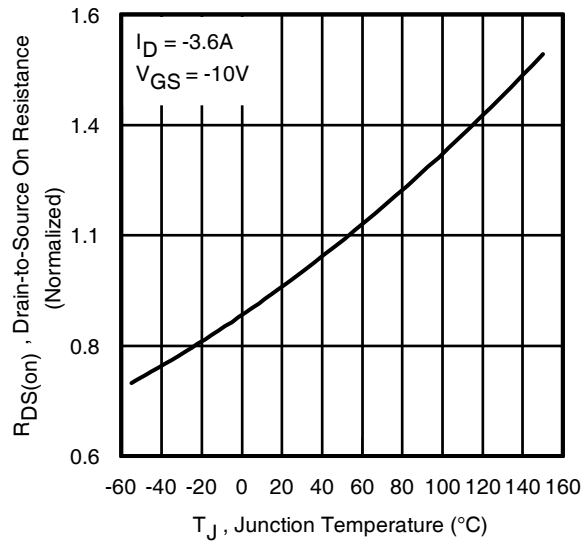
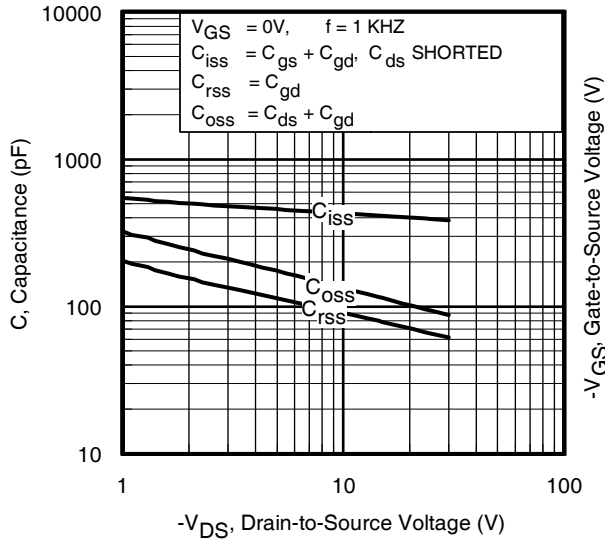
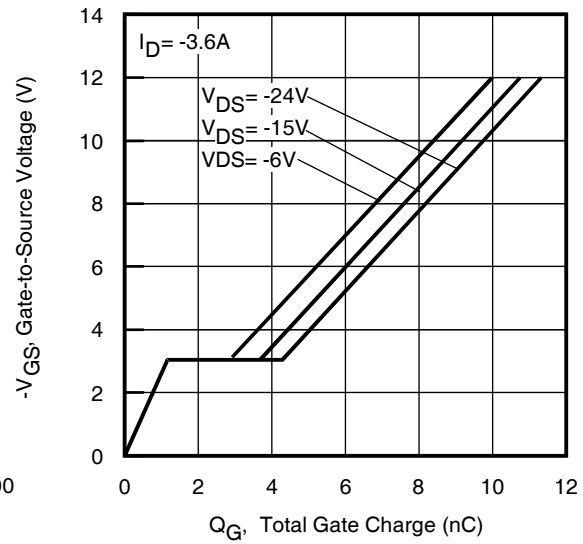

Fig 4. Normalized On-Resistance Vs. Temperature



**Fig 5.** Typical Capacitance Vs. Drain-to-Source Voltage



**Fig 6.** Typical Gate Charge Vs. Gate-to-Source Voltage

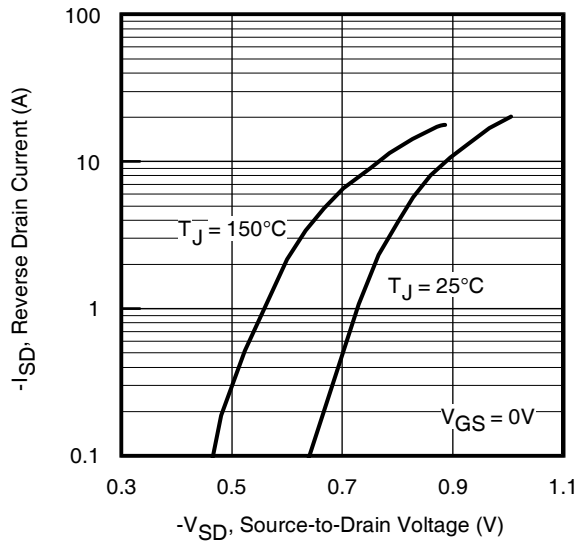

**Fig 7.** Typical Source-Drain Diode Forward Voltage

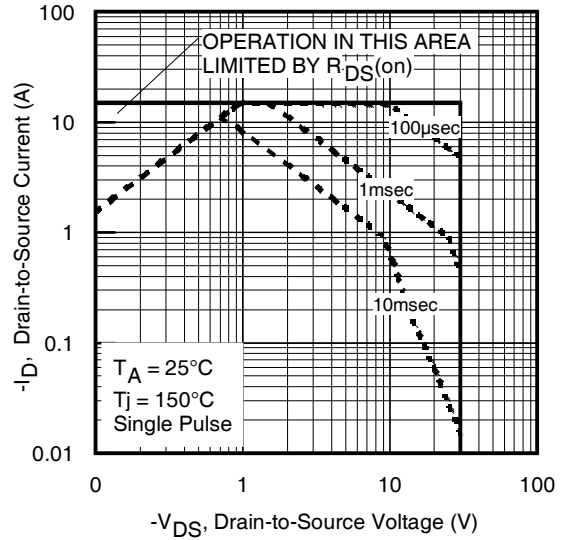

**Fig 8.** Maximum Safe Operating Area

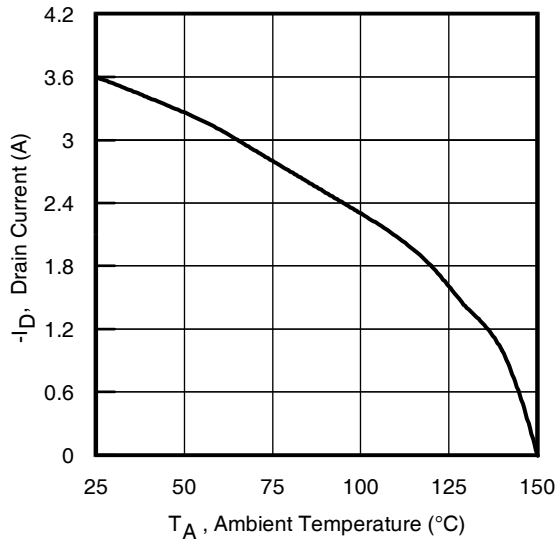

**Fig 9.** Maximum Drain Current Vs. Ambient Temperature

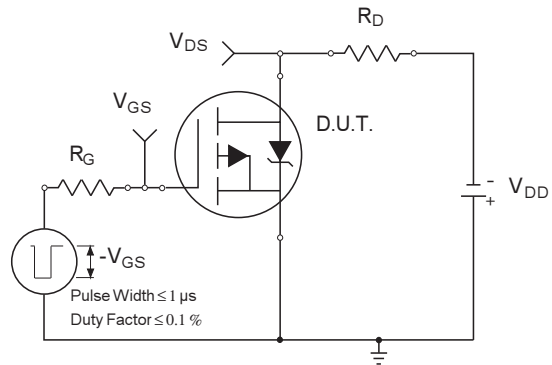

**Fig 10a.** Switching Time Test Circuit

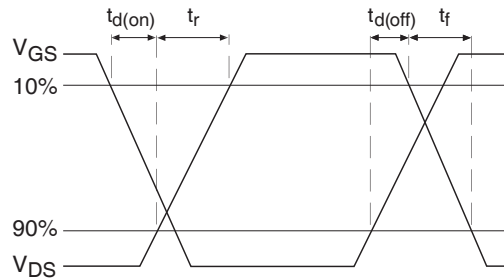

**Fig 10b.** Switching Time Waveforms

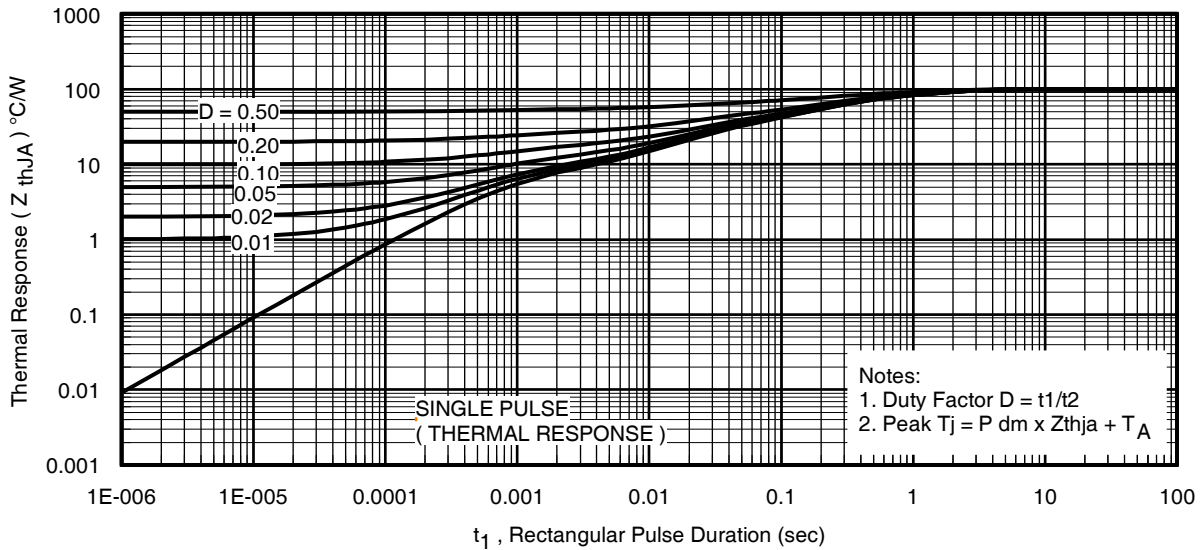

**Fig 11.** Typical Effective Transient Thermal Impedance, Junction-to-Ambient

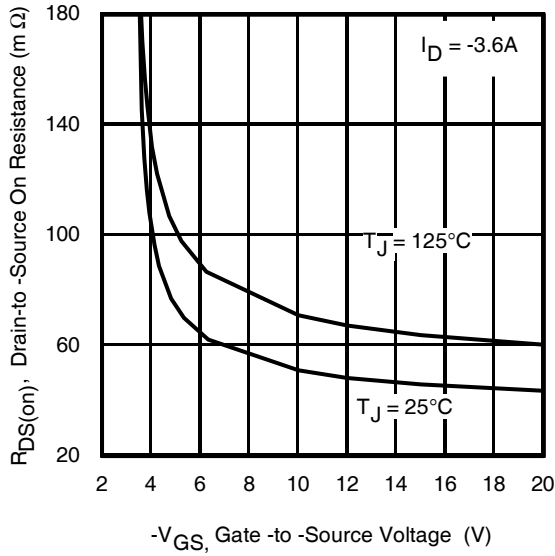

**Fig 12.** Typical On-Resistance Vs. Gate Voltage

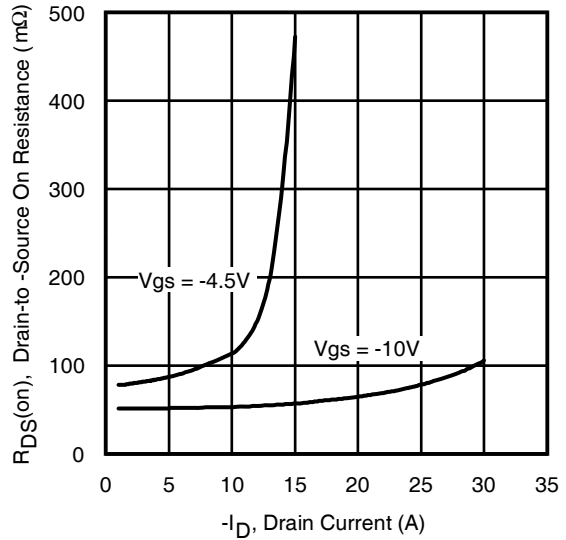

**Fig 13.** Typical On-Resistance Vs. Drain Current

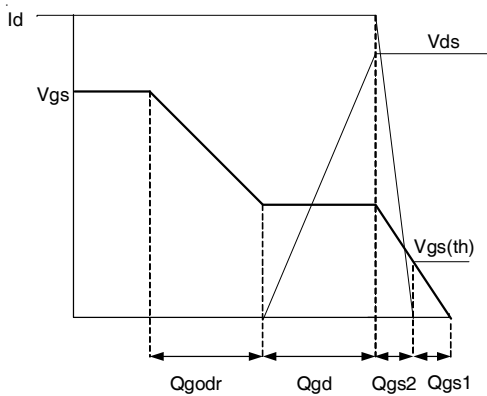

**Fig 14a.** Gate Charge Waveform

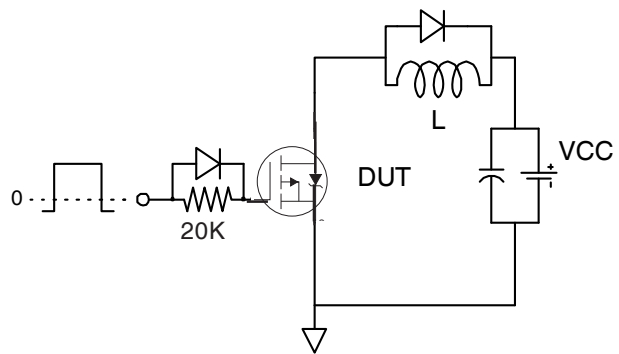

**Fig 14b.** Gate Charge Test Circuit

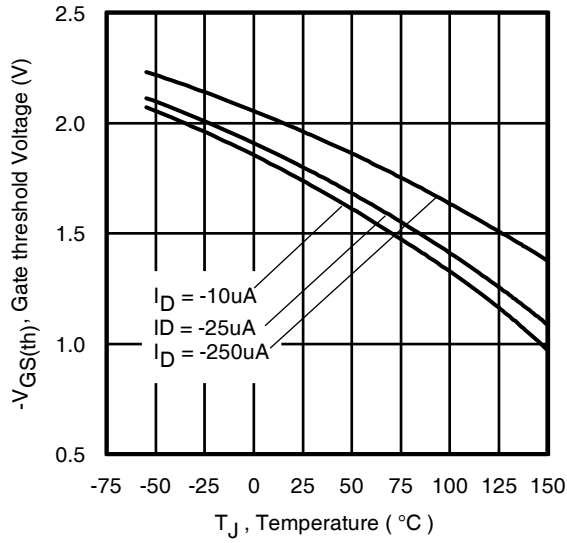

**Fig 15.** Typical Threshold Voltage Vs. Junction Temperature

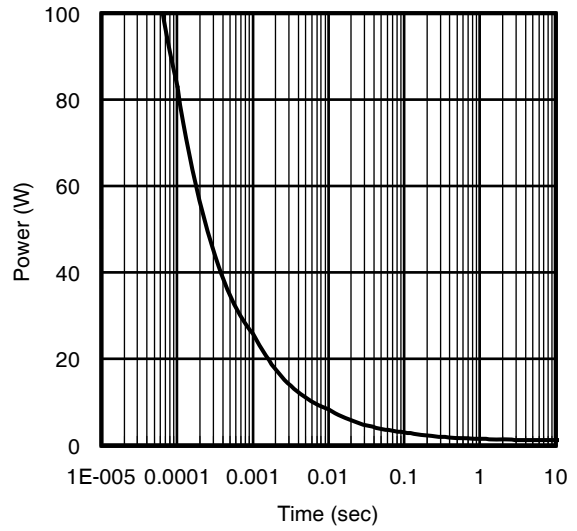

**Fig 16.** Typical Power Vs. Time

# IRLML9301TRPbF

International  
**IR** Rectifier

## Micro3 (SOT-23) Package Outline

Dimensions are shown in millimeters (inches)

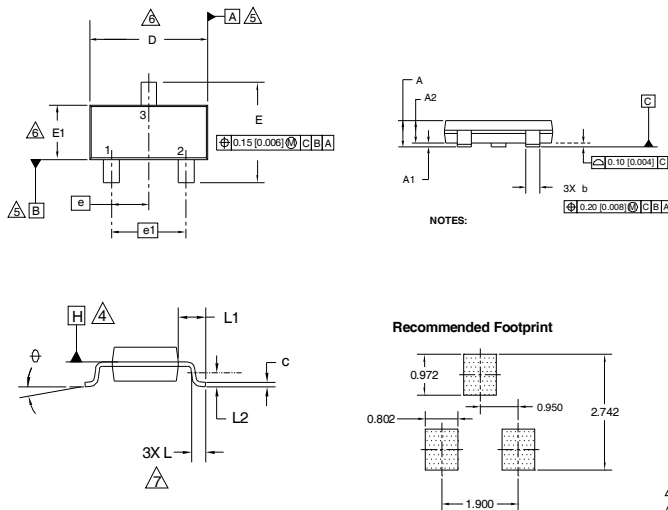

SYMBOL	MILLIMETERS		INCHES	
	MIN	MAX	MIN	MAX
A	0.89	1.12	0.035	0.044
A1	0.01	0.10	0.0004	0.004
A2	0.88	1.02	0.035	0.040
b	0.30	0.50	0.012	0.020
c	0.08	0.20	0.003	0.008
D	2.80	3.04	0.110	0.120
E	2.10	2.64	0.083	0.104
E1	1.20	1.40	0.047	0.055
e	0.95	BSC	0.037	BSC
e1	1.90	BSC	0.075	BSC
L	0.40	0.60	0.016	0.024
L1	0.54	REF	0.021	REF
L2	0.25	BSC	0.010	BSC
⌀	0	8	0	8

1. DIMENSIONING & TOLERANCING PER ANSI Y14.5M-1994
2. DIMENSIONS ARE SHOWN IN MILLIMETERS (INCHES)
3. CONTROLLING DIMENSION: MILLIMETER
4. DATUM PLANE H IS LOCATED AT THE MOLD PARTING LINE
5. DATUM A AND B TO BE DETERMINED AT DATUM PLANE H
6. DIMENSIONS D AND E1 ARE MEASURED AT DATUM PLANE H. DIMENSIONS DOES NOT INCLUDE MOLD PROTRUSIONS OR INTERLEAD FLASH. MOLD PROTRUSIONS OR INTERLEAD FLASH SHALL NOT EXCEED 0.25 MM [0.010 INCH] PER SIDE
7. DIMENSION L IS THE LEAD LENGTH FOR SOLDERING TO A SUBSTRATE
8. OUTLINE CONFORMS TO JEDEC OUTLINE TO-236 AB.

## Micro3 (SOT-23/TO-236AB) Part Marking Information

Notes: This part marking information applies to devices produced after 02/26/2001

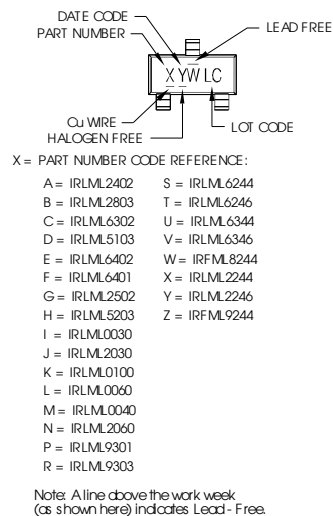

### DATE CODE MARKING INSTRUCTIONS

WW = (1-26) IF PRECEDED BY LAST DIGIT OF CALENDAR YEAR

YEAR	Y	WORK WEEK	W	
2011	2001	1	01	A
2012	2002	2	02	B
2013	2003	3	03	C
2014	2004	4	04	D
2015	2005	5		
2016	2006	6		
2017	2007	7		
2018	2008	8		
2019	2009	9		
2020	2010	0	24	X
			25	Y
			26	Z

WW = (27-52) IF PRECEDED BY A LETTER

YEAR	Y	WORK WEEK	W	
2011	2001	A	27	A
2012	2002	B	28	B
2013	2003	C	29	C
2014	2004	D	30	D
2015	2005	E		
2016	2006	F		
2017	2007	G		
2018	2008	H		
2019	2009	J		
2020	2010	K	50	X
			51	Y
			52	Z

Note: For the most current drawing please refer to IR website at: <http://www.irf.com/package/>



## Micro3™ (SOT-23) Tape & Reel Information

Dimensions are shown in millimeters (inches)

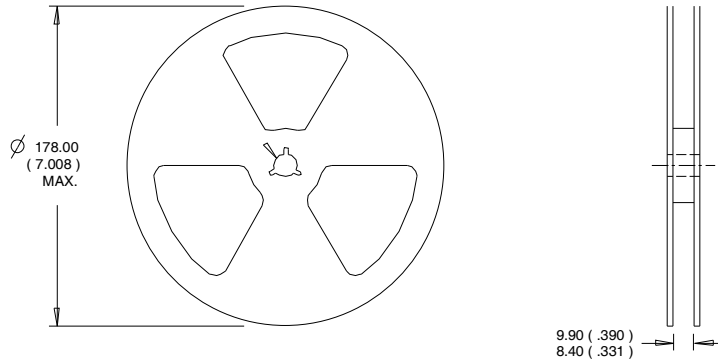
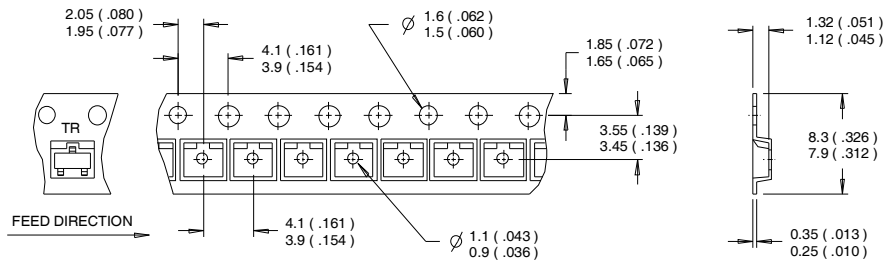

- NOTES:
1. CONTROLLING DIMENSION : MILLIMETER.
  2. OUTLINE CONFORMS TO EIA-481 & EIA-541.

Note: For the most current drawing please refer to IR website at: <http://www.irf.com/package/>  
[www.irf.com](http://www.irf.com)

# IRLML9301TRPbF

International  
**IR** Rectifier

Orderable part number	Package Type	Standard Pack		Note
		Form	Quantity	
IRLML9301TRPbF	Micro3 (SOT-23)	Tape and Reel	3000	

## Qualification information<sup>†</sup>

Qualification level	Consumer <sup>††</sup> (per JEDEC JESD47F <sup>†††</sup> guidelines)	
Moisture Sensitivity Level	Micro3 (SOT-23)	MSL1 (per IPC/JEDEC J-STD-020D <sup>†††</sup> )
RoHS compliant	Yes	

† Qualification standards can be found at International Rectifier's web site  
<http://www.irf.com/product-info/reliability>

†† Higher qualification ratings may be available should the user have such requirements.  
Please contact your International Rectifier sales representative for further information:  
<http://www.irf.com/whoto-call/salesrep/>

††† Applicable version of JEDEC standard at the time of product release.

## Notes:

- ① Repetitive rating; pulse width limited by max. junction temperature.
- ② Pulse width  $\leq 400\mu\text{s}$ ; duty cycle  $\leq 2\%$ .
- ③ Surface mounted on 1 in square Cu board
- ④ Refer to [application note #AN-994](#).

Data and specifications subject to change without notice.

International  
**IR** Rectifier

**IR WORLD HEADQUARTERS:** 101N.Sepulveda blvd, El Segundo, California 90245, USA Tel: (310) 252-7105  
TAC Fax: (310) 252-7903

Visit us at [www.irf.com](http://www.irf.com) for sales contact information.02/2012

[www.irf.com](http://www.irf.com)

# Mouser Electronics

Authorized Distributor

Click to View Pricing, Inventory, Delivery & Lifecycle Information:

[International Rectifier:](#)

[IRLML9301TRPBF](#)