

# 3A Low Quiescent Current 1MHz High Efficiency Synchronous Buck Regulator

## ISL8013A

The ISL8013A is a high efficiency, monolithic, synchronous step-down DC/DC converter that can deliver up to 3A continuous output current from a 2.8V to 5.5V input supply. It uses a current control architecture to deliver very low duty cycle operation at high frequency with fast transient response and excellent loop stability.

The ISL8013A integrates a pair of low ON-resistance P-Channel and N-Channel internal MOSFETs to maximize efficiency and minimize external component count. The 100% duty-cycle operation allows less than 300mV dropout voltage at 3A output current. High 1MHz pulse-width modulation (PWM) switching frequency allows for the use of small external components and the SYNC input enables multiple ICs to synchronize out-of-phase to reduce ripple and eliminate beat frequencies.

The ISL8013A can be configured for discontinuous or forced continuous operation at light load. Forced continuous operation reduces noise and RF interference while discontinuous mode provides high efficiency by reducing switching losses at light loads.

Fault protection is provided by internal hiccup mode current limiting during short circuit and overcurrent conditions, an output overvoltage comparator and over-temperature monitor circuit. A power-good output voltage monitor indicates when the output is in regulation.

The ISL8013A is offered in a space saving 4mmx4mm, Pb-free QFN package with exposed pad leadframes for low thermal resistance.

The ISL8013A includes a pair of low ON-resistance P-Channel and N-Channel internal MOSFETs to maximize efficiency and minimize external component count. The 100% duty-cycle operation allows less than 300mV dropout voltage at 3A.

The ISL8013A offers a 1ms Power-Good (PG) timer at power-up. When shut down, ISL8013A discharges the output capacitor. Other features include internal soft-start, internal compensation, overcurrent protection, and thermal shutdown.

The ISL8013A is offered in a 4mmx4mm 16 Ld QFN package with 1mm maximum height. The complete converter occupies less than 0.4in<sup>2</sup> area.

## Features

- High efficiency synchronous buck regulator with up to 97% efficiency
- Power-good (PG) output with a 1ms delay
- 2.8V to 5.5V supply voltage
- 3% output accuracy over temperature, load, line
- 3A output current
- Start-up with prebiased output
- Internal soft-start - 1ms
- Soft-stop output discharge during disable
- 35µA quiescent supply current in PFM mode
- Selectable forced PWM mode and PFM mode
- External synchronization up to 4MHz
- Less than 1µA logic controlled shutdown current
- 100% maximum duty cycle
- Internal current mode compensation
- Peak current limiting and hiccup mode short-circuit protection
- Over-temperature protection
- Small 16 Ld 4mmx4mm QFN
- Pb-Free (RoHS compliant)

## Applications

- DC/DC POL modules
- µC/µP, FPGA and DSP power
- Plug-in DC/DC modules for routers and switchers
- Portable instruments
- Test and measurement systems
- Li-ion battery powered devices
- Small form factor (SFP) modules
- Barcode readers

# ISL8013A

## Ordering Information

PART NUMBER (Notes 1, 2, 3)	PART MARKING	TEMP. RANGE (°C)	PACKAGE (Pb-Free)	PKG. DWG. #
ISL8013AIRZ	80 13AIRZ	-40 to +85	16 Ld 4x4 QFN	L16.4x4
ISL8013AEVAL2Z	Evaluation Board			

### NOTES:

1. Add "-T\*" suffix for tape and reel. Please refer to [TB347](#) for details on reel specifications.
2. These Intersil Pb-free plastic packaged products employ special Pb-free material sets, molding compounds/die attach materials, and 100% matte tin plate plus anneal (e3 termination finish, which is RoHS compliant and compatible with both SnPb and Pb-free soldering operations). Intersil Pb-free products are MSL classified at Pb-free peak reflow temperatures that meet or exceed the Pb-free requirements of IPC/JEDEC J STD-020.
3. For Moisture Sensitivity Level (MSL), please see device information page for [ISL8013A](#). For more information on MSL please see techbrief [TB363](#).

## Pin Configuration

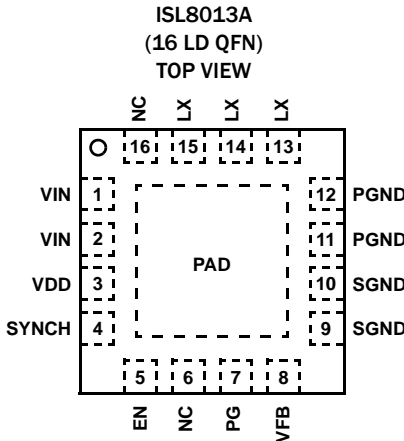

## Pin Descriptions

PIN NUMBER	PIN NAME	DESCRIPTION
1, 2	VIN	Input supply voltage. Connect a 10µF ceramic capacitor to power ground.
3	VDD	Input supply voltage for the analog circuitry. Connect to VIN pin.
5	EN	Regulator enable pin. Enable the output when driven to high. Shut down the chip and discharge output capacitor when driven to low. Do not leave this pin floating.
7	PG	1ms timer output. At power-up or EN HI, this output is a 1ms delayed power-good signal for the output voltage.
4	SYNCH	Mode Selection pin. Connect to logic high or input voltage VDD for PWM mode. Connect to logic low or ground for PFM mode. Connect to an external function generator for synchronization with the negative edge trigger. Do not leave this pin floating.
13, 14, 15	LX	Switching node connection. Connect to one terminal of the inductor.
11, 12	PGND	Power ground
9, 10	SGND	Signal ground
8	VFB	Buck regulator output feedback. Connect to the output through a resistor divider for adjustable output voltage. For 0.8V output voltage, connect this pin to the output.
6, 16	NC	No connect
-	Exposed Pad	The exposed pad must be connected to the SGND pin for proper electrical performance. Place as many vias as possible under the pad connecting to SGND plane for optimal thermal performance.

# ISL8013A

## Typical Application

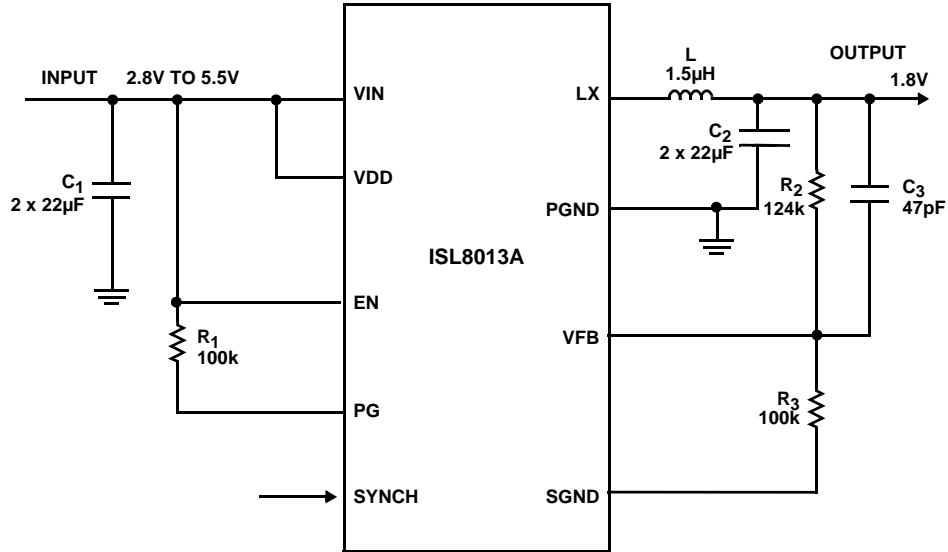

FIGURE 1. TYPICAL APPLICATION DIAGRAM

## Block Diagram

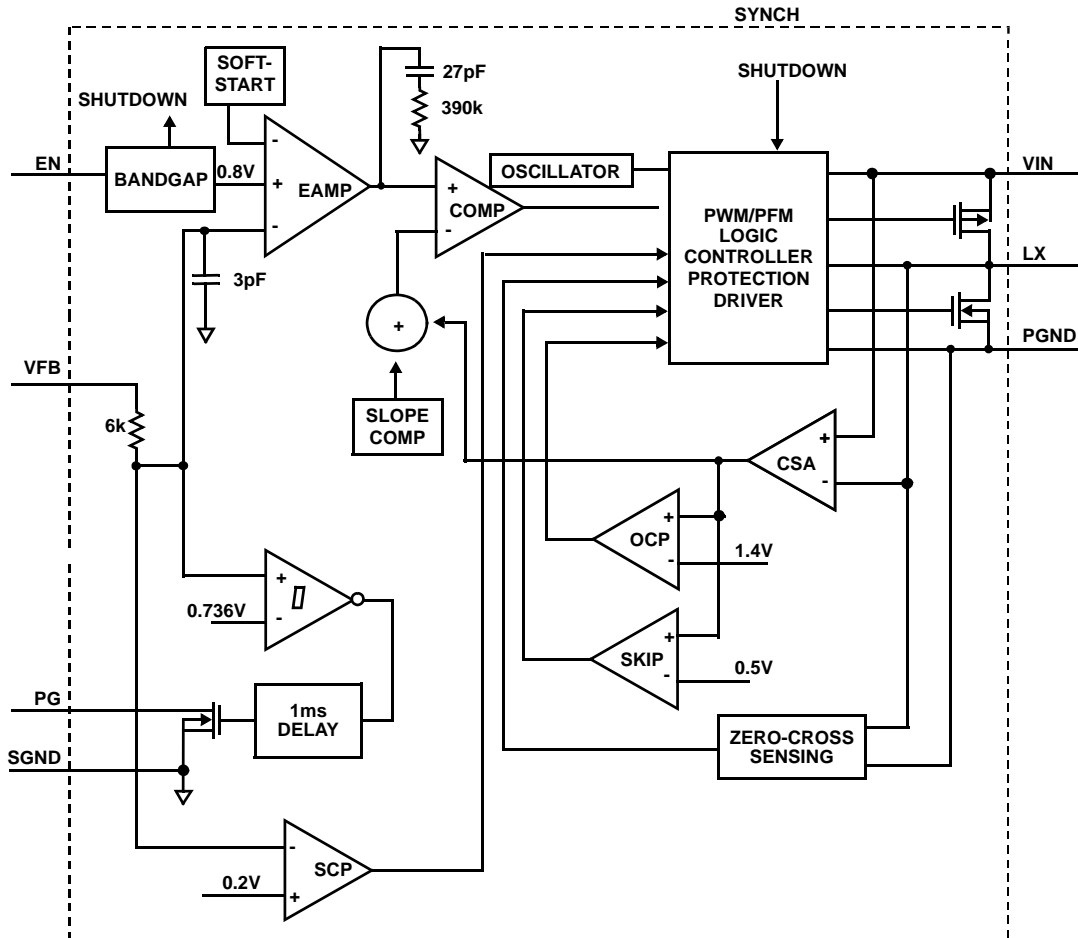

FIGURE 2. FUNCTIONAL BLOCK DIAGRAM

# ISL8013A

## Absolute Maximum Ratings (Reference to GND)

VIN, VDD	-0.3V to 6V (DC) or 7V (20ms)
EN, SYNCH, PG	-0.3V to VIN + 0.3V
LX	-1.5V (100ns)/-0.3V (DC) to 6.5V (DC) or 7V (20ms)
VFB	-0.3V to 2.8V

## Thermal Information

Thermal Resistance (Typical, <a href="#">Notes 4, 5</a> )	$\theta_{JA}$ (°C/W)	$\theta_{JC}$ (°C/W)
16 Ld 4x4 QFN Package	39	3
Junction Temperature Range	-55°C to +125°C	
Storage Temperature Range	-65°C to +150°C	
Pb-Free Reflow Profile	see <a href="#">TB493</a>	

## Recommended Operating Conditions

VIN Supply Voltage Range	2.8V to 5.5V
Load Current Range	0A to 3A
Ambient Temperature Range	-40°C to +85°C

**CAUTION:** Do not operate at or near the maximum ratings listed for extended periods of time. Exposure to such conditions may adversely impact product reliability and result in failures not covered by warranty.

### NOTES:

- $\theta_{JA}$  is measured in free air with the component mounted on a high effective thermal conductivity test board with “direct attach” features. See Tech Brief [TB379](#).
- $\theta_{JC}$ , “case temperature” location is at the center of the exposed metal pad on the package underside.

## Electrical Specifications

Unless otherwise noted, all parameter limits are established over the recommended operating conditions and the typical specification are measured at the following conditions unless otherwise noted:  $T_A = -40^\circ\text{C}$  to  $+85^\circ\text{C}$ ,  $V_{IN} = 3.6\text{V}$ ,  $EN = V_{DD}$ . Typical values are at  $T_A = +25^\circ\text{C}$ . **Boldface limits apply across the operating temperature range,  $-40^\circ\text{C}$  to  $+85^\circ\text{C}$ .**

PARAMETER	SYMBOL	TEST CONDITIONS	MIN ( <a href="#">Note 7</a> )	TYP	MAX ( <a href="#">Note 7</a> )	UNITS
<b>INPUT SUPPLY</b>						
VIN Undervoltage Lockout Threshold	V <sub>UVLO</sub>	Rising, no load	-	2.6	<b>2.8</b>	V
		Falling, no load	<b>2.15</b>	2.35	-	V
Quiescent Supply Current	I <sub>VIN</sub>	SYNCH = GND, no load at the output	-	35	-	μA
		SYNCH = GND, no load at the output and no switches switching	-	30	<b>45</b>	μA
		SYNCH = VDD, F <sub>S</sub> = 1MHz, no load at the output	-	6.5	<b>10</b>	mA
Shut Down Supply Current	I <sub>SD</sub>	V <sub>IN</sub> = 5.5V, EN = low	-	0.1	<b>2</b>	μA
<b>OUTPUT REGULATION</b>						
Reference Voltage	V <sub>REF</sub>		<b>0.790</b>	0.8	<b>0.810</b>	V
VFB Bias Current	I <sub>VFB</sub>	VFB = 0.75V	-	0.1	-	μA
Line Regulation		V <sub>IN</sub> = V <sub>O</sub> + 0.5V to 5.5V (minimal 2.8V)	-	0.2	-	%/V
Soft-Start Ramp Time Cycle			-	<b>1</b>	-	ms
<b>OVERCURRENT PROTECTION</b>						
Current Limit Blanking Time	t <sub>OCON</sub>		-	17	-	Clock pulses
Overcurrent and Auto Restart Period	t <sub>OCOFF</sub>		-	4	-	SS cycle
Switch Current Limit	I <sub>LIMIT</sub>	<a href="#">(Note 6)</a>	<b>4.0</b>	4.8	<b>5.9</b>	A
Peak Skip Limit	I <sub>SKIP</sub>	<a href="#">(Note 6)</a>	-	1.2	-	A
<b>COMPENSATION</b>						
Error Amplifier Transconductance			-	20	-	μA/V
Trans-Resistance	RT		<b>0.213</b>	0.25	<b>0.287</b>	Ω
<b>LX</b>						
P-Channel MOSFET ON-resistance		V <sub>IN</sub> = 5V, I <sub>O</sub> = 200mA	-	50	<b>75</b>	mΩ
		V <sub>IN</sub> = 2.8V, I <sub>O</sub> = 200mA	-	70	<b>100</b>	mΩ

# ISL8013A

**Electrical Specifications** Unless otherwise noted, all parameter limits are established over the recommended operating conditions and the typical specification are measured at the following conditions unless otherwise noted:  $T_A = -40^\circ\text{C}$  to  $+85^\circ\text{C}$ ,  $V_{IN} = 3.6\text{V}$ ,  $EN = V_{DD}$ . Typical values are at  $T_A = +25^\circ\text{C}$ . **Boldface limits apply across the operating temperature range,  $-40^\circ\text{C}$  to  $+85^\circ\text{C}$ .** (Continued)

PARAMETER	SYMBOL	TEST CONDITIONS	MIN (Note 7)	TYP	MAX (Note 7)	UNITS
N-Channel MOSFET ON-Resistance		$V_{IN} = 5\text{V}$ , $I_O = 200\text{mA}$	-	50	<b>75</b>	$\text{m}\Omega$
		$V_{IN} = 2.8\text{V}$ , $I_O = 200\text{mA}$	-	70	<b>100</b>	$\text{m}\Omega$
LX Maximum Duty Cycle			-	100	-	%
PWM Switching Frequency	$f_S$		<b>0.80</b>	1.00	<b>1.20</b>	MHz
LX Minimum On-Time		SYNCH = High	-	-	<b>140</b>	ns
<b>PG</b>						
Output Low Voltage		Sinking 1mA	-	-	<b>0.3</b>	V
Delay Time (Rising Edge)			<b>0.65</b>	1	<b>1.35</b>	ms
PG Pin Leakage Current		PG = $V_{IN} = 3.6\text{V}$	-	0.01	<b>0.1</b>	$\mu\text{A}$
PGOOD Rising Threshold		Percentage of regulation voltage	<b>89</b>	92	<b>95</b>	%
PGOOD Falling Threshold		Percentage of regulation voltage	<b>85</b>	88	<b>91.5</b>	%
PGOOD Delay Time (Falling Edge)			-	15	-	$\mu\text{s}$
<b>EN, SYNCH</b>						
Logic Input Low			-	-	<b>0.4</b>	V
Logic Input High			<b>1.4</b>	-	-	V
Synch Logic Input Leakage Current	$I_{SYNCH}$	Pulled up to 5.5V	-	0.1	<b>1</b>	$\mu\text{A}$
Enable Logic Input Leakage Current	$I_{EN}$		-	0.1	<b>1</b>	$\mu\text{A}$
Thermal Shutdown			-	140	-	$^\circ\text{C}$
Thermal Shutdown Hysteresis			-	25	-	$^\circ\text{C}$

**NOTES:**

- Limits established by characterization and are not production tested.
- Parameters with MIN and/or MAX limits are 100% tested at  $+25^\circ\text{C}$ , unless otherwise specified. Temperature limits established by characterization and are not production tested.

**Typical Operating Performance** Unless otherwise noted, operating conditions are:  $T_A = +25^\circ\text{C}$ ,  $V_{IN} = 2.5\text{V to } 5.5\text{V}$ ,  $EN = V_{IN}$ ,  $SYNCH = 0\text{V}$ ,  $L = 1.5\mu\text{H}$ ,  $C_1 = 2 \times 22\mu\text{F}$ ,  $C_2 = 2 \times 22\mu\text{F}$ ,  $I_{OUT} = 0\text{A to } 3\text{A}$ .

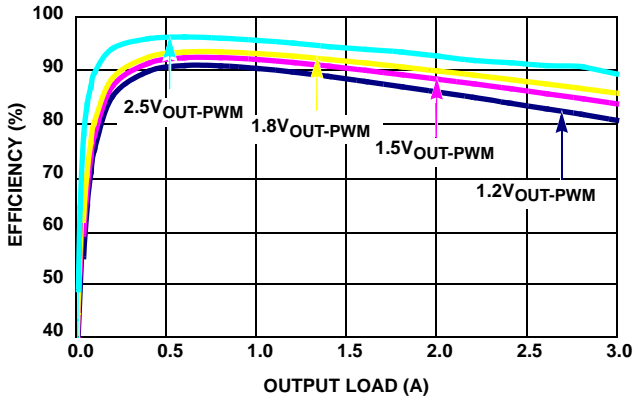

FIGURE 3. EFFICIENCY vs LOAD (1MHz 3.3  $V_{IN}$  PWM)

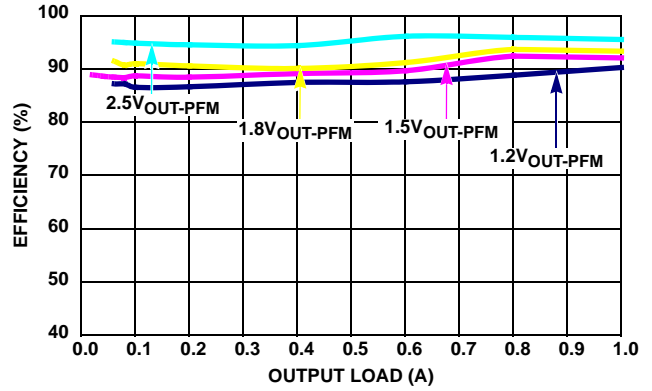

FIGURE 4. EFFICIENCY vs LOAD (1MHz 3.3  $V_{IN}$  PFM)

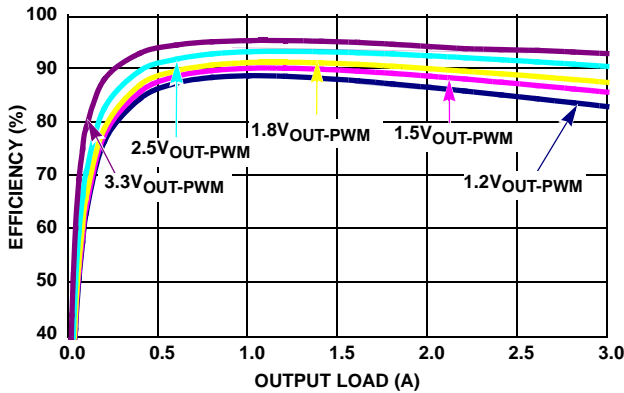

FIGURE 5. EFFICIENCY vs LOAD (1MHz 5 $V_{IN}$  PWM)

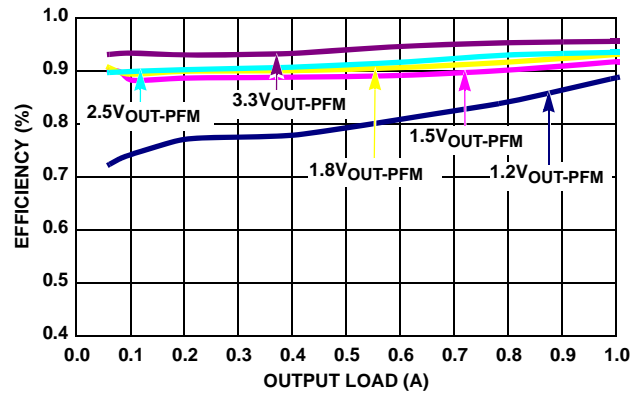

FIGURE 6. EFFICIENCY vs LOAD (1MHz 5 $V_{IN}$  PFM)

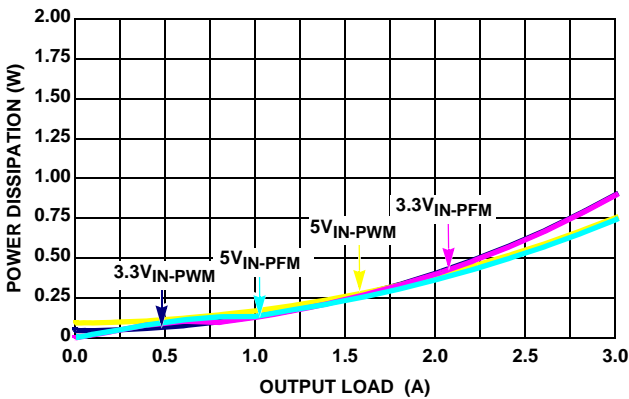

FIGURE 7. POWER DISSIPATION vs LOAD (1MHz,  $V_{OUT} = 1.8\text{V}$ )

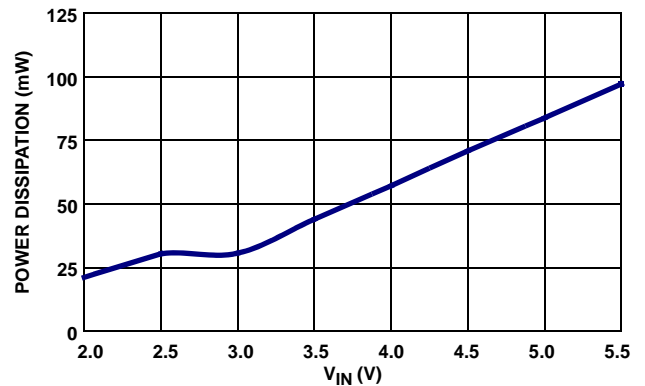

FIGURE 8. POWER DISSIPATION WITH NO LOAD vs  $V_{IN}$  (PWM  $V_{OUT} = 1.8\text{V}$ )

# ISL8013A

**Typical Operating Performance** Unless otherwise noted, operating conditions are:  $T_A = +25^\circ\text{C}$ ,  $V_{IN} = 2.5\text{V to }5.5\text{V}$ ,  $EN = V_{IN}$ ,  $SYNCH = 0\text{V}$ ,  $L = 1.5\mu\text{H}$ ,  $C_1 = 2 \times 22\mu\text{F}$ ,  $C_2 = 2 \times 22\mu\text{F}$ ,  $I_{OUT} = 0\text{A to }3\text{A}$ . (Continued)

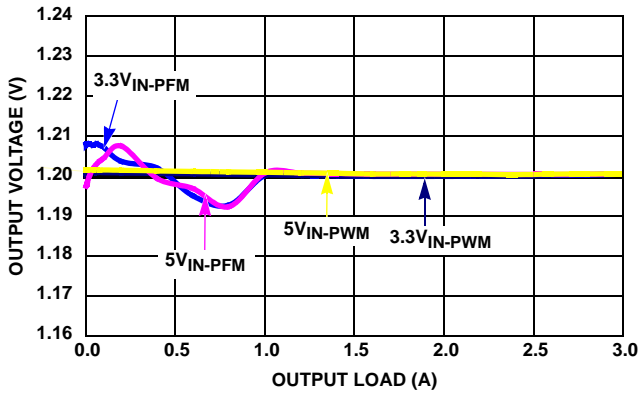

FIGURE 9.  $V_{OUT}$  REGULATION vs LOAD (1MHz,  $V_{OUT} = 1.2\text{V}$ )

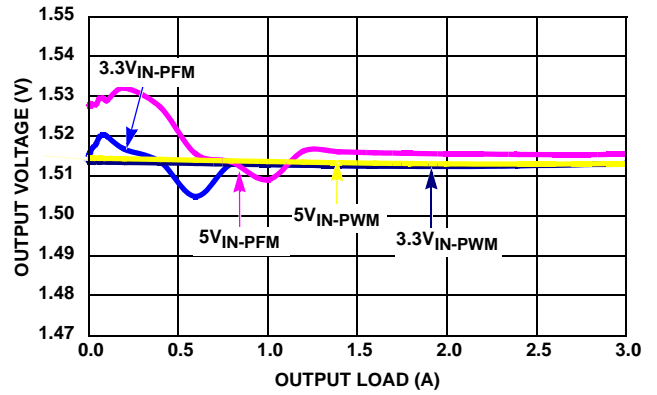

FIGURE 10.  $V_{OUT}$  REGULATION vs LOAD (1MHz,  $V_{OUT} = 1.5\text{V}$ )

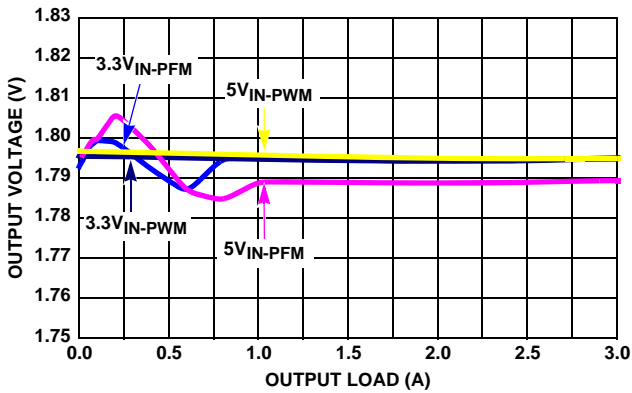

FIGURE 11.  $V_{OUT}$  REGULATION vs LOAD (1MHz,  $V_{OUT} = 1.8\text{V}$ )

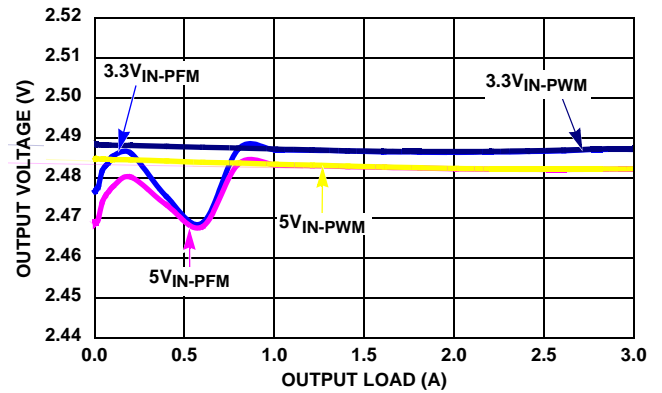

FIGURE 12.  $V_{OUT}$  REGULATION vs LOAD (1MHz,  $V_{OUT} = 2.5\text{V}$ )

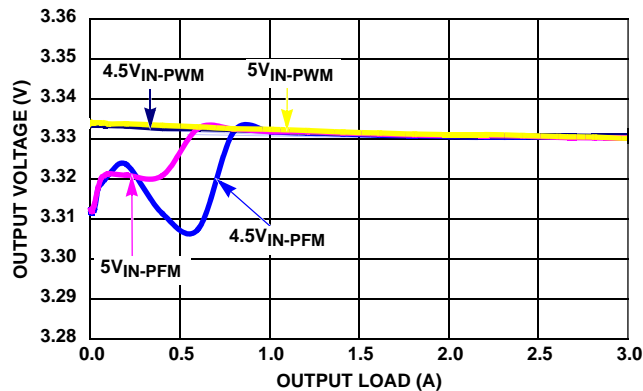

FIGURE 13.  $V_{OUT}$  REGULATION vs LOAD (1MHz,  $V_{OUT} = 3.3\text{V}$ )

**Typical Operating Performance** Unless otherwise noted, operating conditions are:  $T_A = +25^\circ\text{C}$ ,  $V_{IN} = 2.5\text{V to }5.5\text{V}$ ,  $EN = V_{IN}$ ,  $SYNCH = 0\text{V}$ ,  $L = 1.5\mu\text{H}$ ,  $C_1 = 2 \times 22\mu\text{F}$ ,  $C_2 = 2 \times 22\mu\text{F}$ ,  $I_{OUT} = 0\text{A to }3\text{A}$ . (Continued)

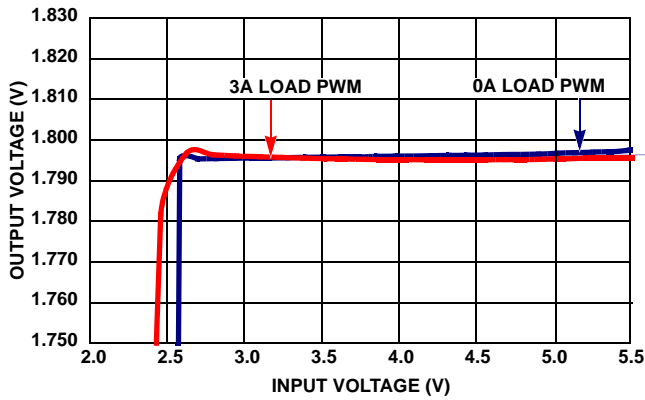

FIGURE 14. OUTPUT VOLTAGE REGULATION vs VIN (PWM  $V_{OUT} = 1.8$ )

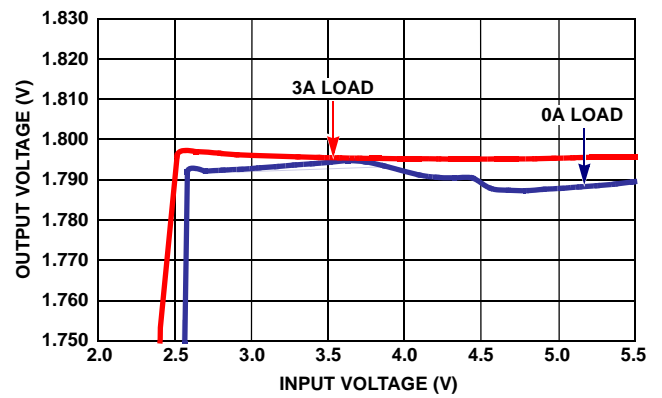

FIGURE 15. OUTPUT VOLTAGE REGULATION vs VIN (PFM  $V_{OUT} = 1.8\text{V}$ )

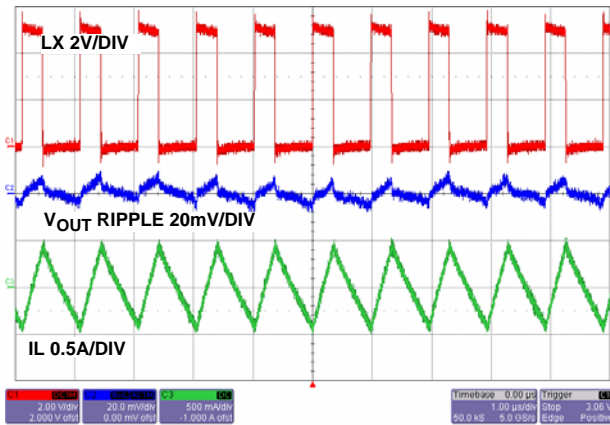

FIGURE 16. STEADY STATE OPERATION AT NO LOAD (PWM)

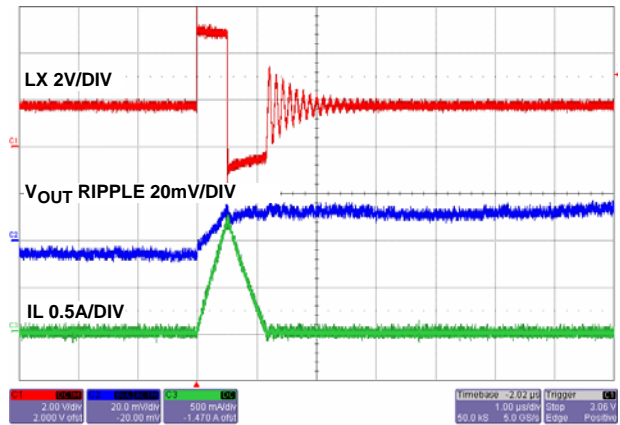

FIGURE 17. STEADY STATE OPERATION AT NO LOAD (PFM)

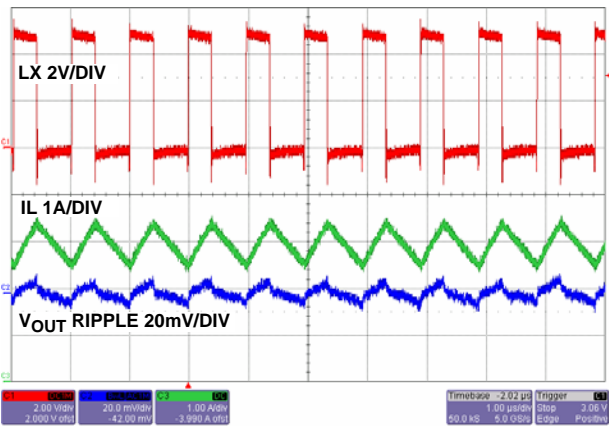

FIGURE 18. STEADY STATE OPERATION WITH FULL LOAD

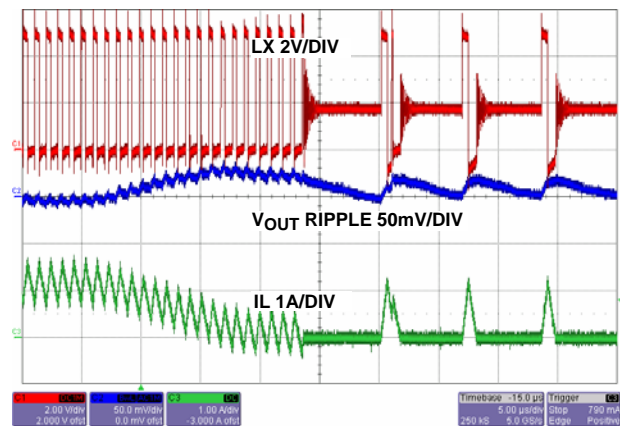

FIGURE 19. MODE TRANSITION CCM TO DCM



**Typical Operating Performance** Unless otherwise noted, operating conditions are:  $T_A = +25^\circ\text{C}$ ,  $V_{IN} = 2.5\text{V}$  to  $5.5\text{V}$ ,  $EN = V_{IN}$ ,  $SYNCH = 0\text{V}$ ,  $L = 1.5\mu\text{H}$ ,  $C_1 = 2 \times 22\mu\text{F}$ ,  $C_2 = 2 \times 22\mu\text{F}$ ,  $I_{OUT} = 0\text{A}$  to  $3\text{A}$ . (Continued)

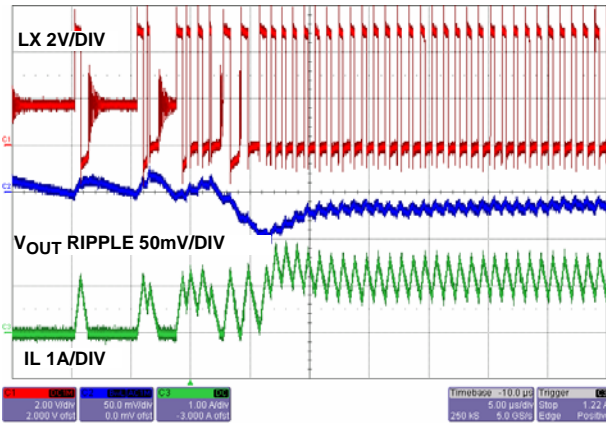

FIGURE 20. MODE TRANSITION DCM TO CCM

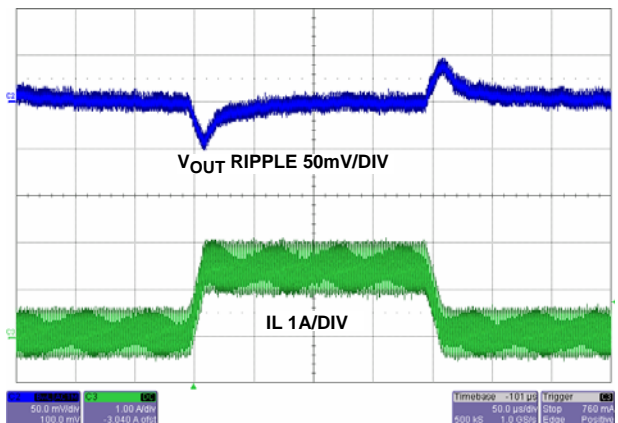

FIGURE 21. LOAD TRANSIENT (PWM)

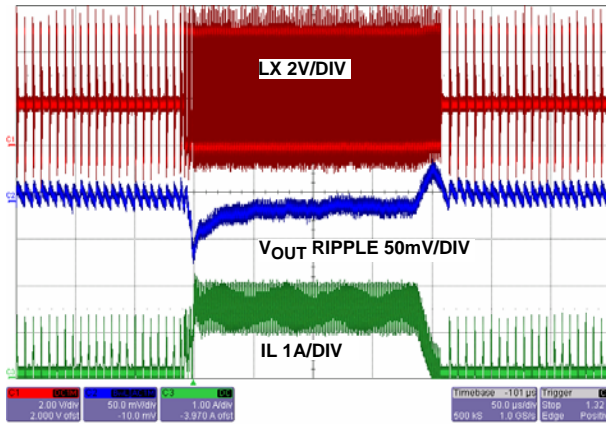

FIGURE 22. LOAD TRANSIENT (PFM)

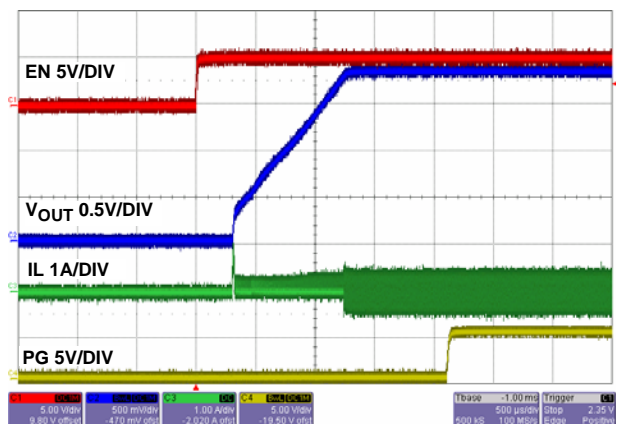

FIGURE 23. SOFT-START WITH NO LOAD (PWM)

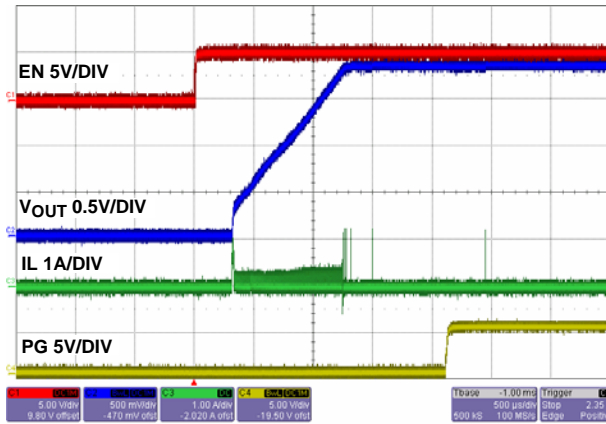

FIGURE 24. SOFT-START AT NO LOAD (PFM)

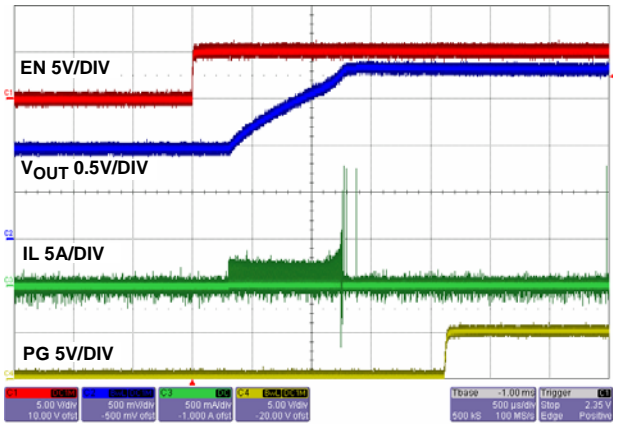

FIGURE 25. SOFT-START WITH PREBIASED 1V

**Typical Operating Performance** Unless otherwise noted, operating conditions are:  $T_A = +25^\circ\text{C}$ ,  $V_{IN} = 2.5\text{V to }5.5\text{V}$ ,  $EN = V_{IN}$ ,  $SYNCH = 0\text{V}$ ,  $L = 1.5\mu\text{H}$ ,  $C_1 = 2 \times 22\mu\text{F}$ ,  $C_2 = 2 \times 22\mu\text{F}$ ,  $I_{OUT} = 0\text{A to }3\text{A}$ . (Continued)

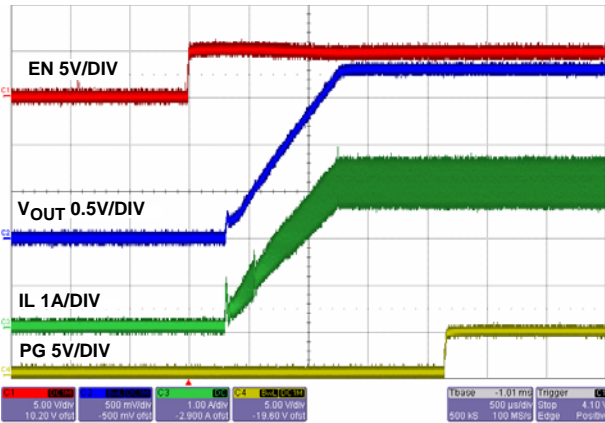

FIGURE 26. SOFT-START AT FULL LOAD

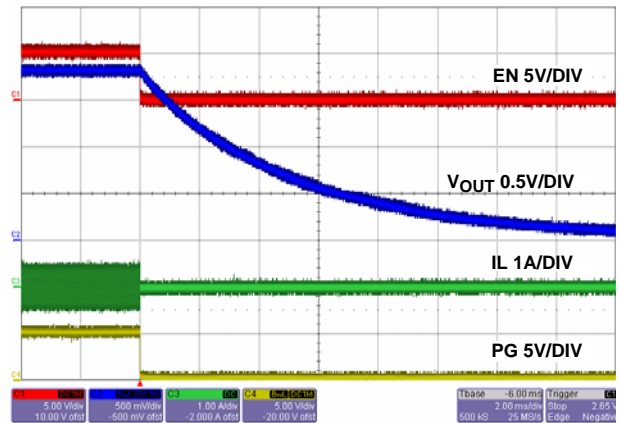

FIGURE 27. SOFT-DISCHARGE SHUTDOWN

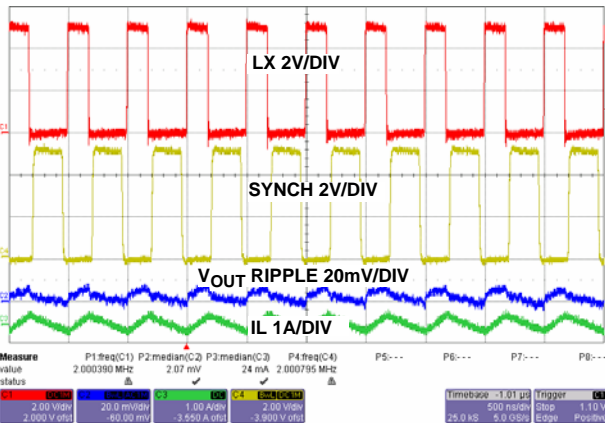

FIGURE 28. STEADY STATE OPERATION AT NO LOAD WITH FREQUENCY = 2MHz

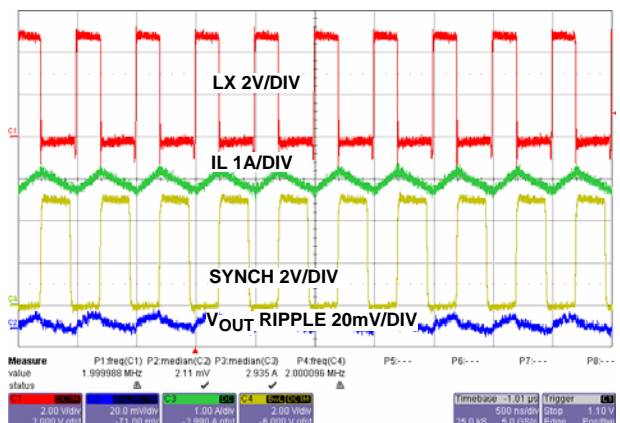

FIGURE 29. STEADY STATE OPERATION AT FULL LOAD WITH FREQUENCY = 2MHz

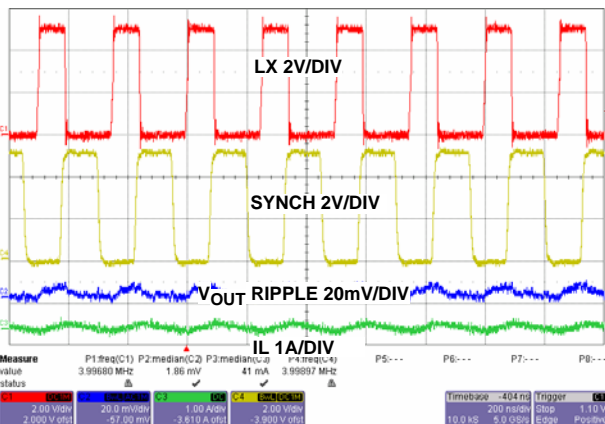

FIGURE 30. STEADY STATE OPERATION AT NO LOAD WITH FREQUENCY = 4MHz

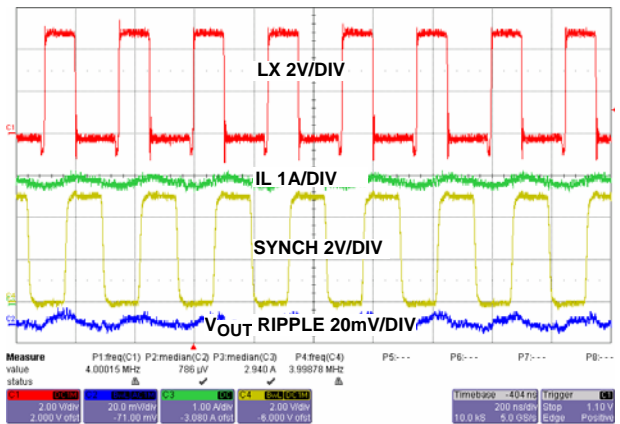

FIGURE 31. STEADY STATE OPERATION AT FULL LOAD (PWM) WITH FREQUENCY = 4MHz

**Typical Operating Performance** Unless otherwise noted, operating conditions are:  $T_A = +25^\circ\text{C}$ ,  $V_{IN} = 2.5\text{V}$  to  $5.5\text{V}$ ,  $EN = V_{IN}$ ,  $SYNCH = 0\text{V}$ ,  $L = 1.5\mu\text{H}$ ,  $C_1 = 2 \times 22\mu\text{F}$ ,  $C_2 = 2 \times 22\mu\text{F}$ ,  $I_{OUT} = 0\text{A}$  to  $3\text{A}$ . (Continued)

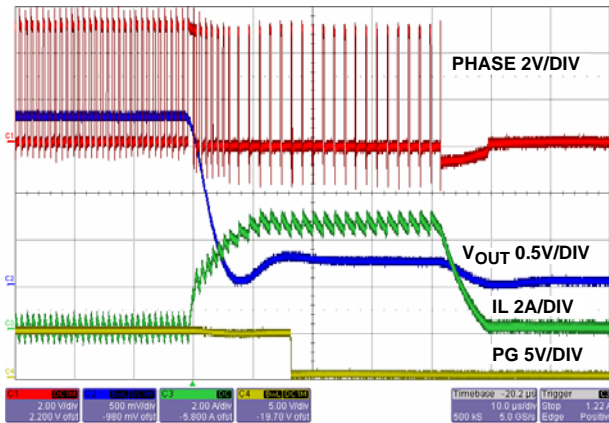

FIGURE 32. OUTPUT SHORT-CIRCUIT

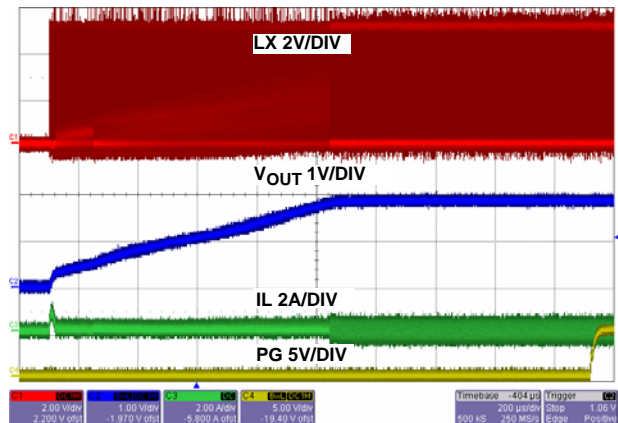

FIGURE 33. OUTPUT SHORT-CIRCUIT RECOVERY

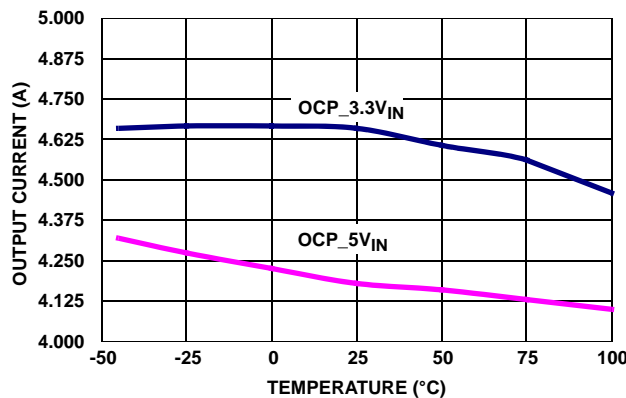

FIGURE 34. OUTPUT CURRENT LIMIT vs TEMPERATURE

## Theory of Operation

The ISL8013A is a step-down switching regulator optimized for battery-powered handheld applications. The regulator operates at 1MHz fixed switching frequency under heavy load conditions to allow smaller external inductors and capacitors to be used for minimal printed-circuit board (PCB) area. At light load, the regulator reduces the switching frequency, unless forced to the fixed frequency, to minimize the switching loss and to maximize the battery life. The quiescent current, when the output is not loaded, is typically only 35 $\mu\text{A}$ . The supply current is typically only 0.1 $\mu\text{A}$  when the regulator is shut down.

### PWM Control Scheme

Pulling the SYNCH pin HI (>2.5V) forces the converter into PWM mode, regardless of output current. The ISL8013A employs the current-mode pulse-width modulation (PWM) control scheme for fast transient response and pulse-by-pulse current limiting. Figure 2 shows the block diagram. The current loop consists of the oscillator, the PWM comparator, current sensing circuit and the slope compensation for the current loop stability. The gain for the current sensing circuit is typically 250mV/A. The control reference for the current loops comes from the error amplifier's (EAMP) output.

The PWM operation is initialized by the clock from the oscillator. The P-Channel MOSFET is turned on at the beginning of a PWM cycle and the current in the MOSFET starts to ramp up. When the sum of the current amplifier CSA and the slope compensation (237mV/ $\mu\text{s}$ ) reaches the control reference of the current loop, the PWM comparator COMP sends a signal to the PWM logic to turn off the P-MOSFET and turn on the N-Channel MOSFET. The N-MOSFET stays on until the end of the PWM cycle. Figure 35 shows the typical operating waveforms during the PWM operation. The dotted lines illustrate the sum of the slope compensation ramp and the current-sense amplifier's CSA output.

The output voltage is regulated by controlling the  $V_{EAMP}$  voltage to the current loop. The bandgap circuit outputs a 0.8V reference voltage to the voltage loop. The feedback signal comes from the VFB pin. The soft-start block only affects the operation during the start-up and will be discussed separately. The error amplifier is a transconductance amplifier that converts the voltage error signal to a current output. The voltage loop is internally compensated with the 27pF and 390k $\Omega$  RC network. The maximum EAMP voltage output is precisely clamped to 1.6V.

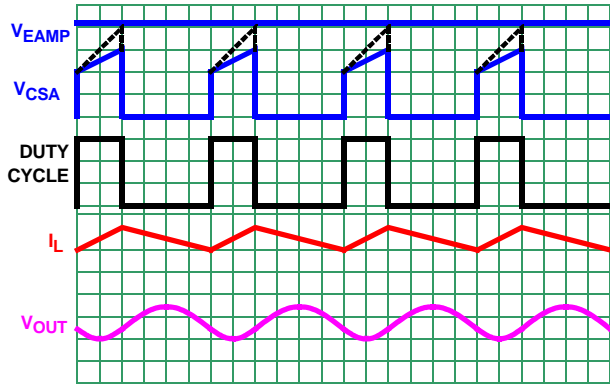

FIGURE 35. PWM OPERATION WAVEFORMS

## SKIP Mode

Pulling the SYNCH pin LO ( $<0.4V$ ) forces the converter into PFM mode. The ISL8013A enters a pulse-skipping mode at light load to minimize the switching loss by reducing the switching frequency. Figure 36 illustrates the skip-mode operation. A zero-cross sensing circuit shown in Figure 2 monitors the N-MOSFET current for zero crossing. When 8 consecutive cycles of the inductor current crossing zero are detected, the regulator enters the skip mode. During the eight detecting cycles, the current in the inductor is allowed to become negative. The counter is reset to zero when the current in any cycle does not cross zero.

Once the skip mode is entered, the pulse modulation starts being controlled by the SKIP comparator shown in Figure 2. Each pulse cycle is still synchronized by the PWM clock. The P-MOSFET is turned on at the clock's rising edge and turned off when the output is higher than 1.5% of the nominal regulation or when its current reaches the peak skip current limit value. Then the inductor current is discharging to 0A and stays at zero. The internal clock is disabled. The output voltage reduces gradually due to the load current discharging the output capacitor. When the output voltage drops to the nominal voltage, the P-MOSFET will be turned on again at the rising edge of the internal clock as it repeats the previous operations.

The regulator resumes normal PWM mode operation when the output voltage drops 1.5% below the nominal voltage.

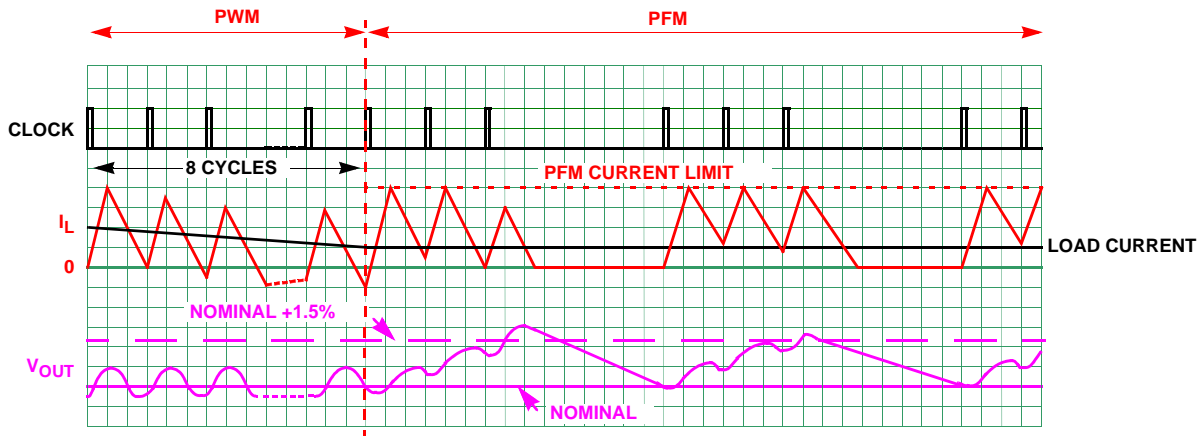

FIGURE 36. SKIP MODE OPERATION WAVEFORMS

## Synchronization Control

The frequency of operation can be synchronized up to 4MHz by an external signal applied to the SYNCH pin. The falling edge on the SYNCH triggers the rising edge of the LX pulse. Make sure that the minimum on time of the LX node is greater than 140ns.

## Overcurrent Protection

The overcurrent protection is realized by monitoring the CSA output with the OCP comparator, as shown in Figure 2. The current sensing circuit has a gain of 250mV/A, from the P-MOSFET current to the CSA output. When the CSA output reaches 1.4V, which is equivalent to 4.8A for the switch current, the OCP comparator is tripped to turn off the P-MOSFET immediately. The overcurrent function protects the switching converter from a shorted output by monitoring the current flowing through the upper MOSFET.

Upon detection of an overcurrent condition, the upper MOSFET will be immediately turned off and will not be turned on again until the next switching cycle. Upon detection of the initial overcurrent condition, the overcurrent fault counter is set to 1. If, on the subsequent cycle, another overcurrent condition is detected, the OC fault counter will be incremented. If there are 17 sequential OC fault detections, the regulator will be shut down under an overcurrent fault condition. An overcurrent fault condition will result in the regulator attempting to restart in a hiccup mode within the delay of four soft-start periods. At the end of the fourth soft-start wait period, the fault counters are reset and soft-start is attempted again. If the overcurrent condition goes away during the delay of four soft-start periods, the output will resume back into regulation point after hiccup mode expires.

## Short-Circuit Protection

The short-circuit protection SCP comparator monitors the VFB pin voltage for output short-circuit protection. When the VFB is lower than 0.2V, the SCP comparator forces the PWM oscillator frequency to drop to 1/3 of the normal operation value. This comparator is effective during start-up or an output short-circuit event.

## PG

During power-up, the open-drain power-good output holds low for about 1ms after  $V_{OUT}$  reaches the regulation voltage. The PG output also serves as a 1ms delayed the power-good signal when the pull-up resistor  $R_1$  is installed.

## UVLO

When the input voltage is below the undervoltage lockout (UVLO) threshold, the regulator is disabled. To adjust the voltage level of power on and UVLO, use a resistive divider across EN. The input voltage programming resistor  $R_4$  will depend on the bottom resistor  $R_5$ , as referred to in [Figure 37](#). The value of  $R_5$  is typically between 10k $\Omega$  and 100k $\Omega$ .

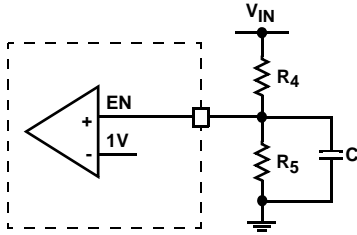

FIGURE 37. EXTERNAL RESISTOR DIVIDER

## Soft Start-up

The soft start-up reduces the in-rush current during the start-up. The soft-start block outputs a ramp reference to the input of the error amplifier. This voltage ramp limits the inductor current as well as the output voltage speed so that the output voltage rises in a controlled fashion. When VFB is less than 0.2V at the beginning of the soft-start, the switching frequency is reduced to 1/3 of the nominal value so that the output can start-up smoothly at light load condition. During soft-start, the IC operates in the SKIP mode to support prebiased output conditions.

## Enable

The enable (EN) input allows the user to control the turning on or off the regulator for purposes such as power-up sequencing. When the regulator is enabled, there is typically a 600 $\mu$ s delay for waking up the bandgap reference and then the soft-start-up begins. It is recommended that the EN voltage should be kept logic low (less than 400mV), until  $V_{IN}$  reaches 2.5V. Refer to [Figures 37](#) and [38](#) for suggested circuit implementation with  $V_{IN}$  slew rate.

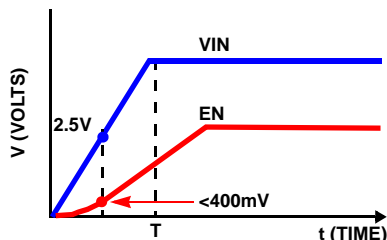

FIGURE 38. CIRCUIT IMPLEMENTATION WITH  $V_{IN}$  SLEW RATE

Let T equal the rise time of  $V_{IN}$ . Select the ratio of  $R_5$  and  $R_4$  such that the voltage is 1.4V (minimum enable logic high threshold) when  $V_{IN}$  is equal to or greater than 2.5V. Set  $R_5$

between 10k $\Omega$  to 100k $\Omega$ , and use [Equation 1](#) to determine  $R_4$ :

$$R_4 = \frac{R_5 \cdot (V_{IN} - 1.4V)}{1.4V} \quad (\text{EQ. 1})$$

Where  $V_{IN}$  is greater than or equal to 2.5V.

Then select C such that the equivalent time constant is at least 2x the rise time, T. This will delay the EN voltage enough so that the overall EN voltage is less than 400mV by the time  $V_{IN}$  reaches 2.5V. Use [Equation 2](#) to get C:

$$C \geq \frac{2 \cdot T}{R_4 \parallel R_5} \quad (\text{EQ. 2})$$

Where T is the rise time of  $V_{IN}$

As an example, let  $V_{IN} = 5V$  with rise time,  $T = 10ms$ . Then  $R_4 = 56.2k\Omega$ ,  $R_5 = 71.5k\Omega$ , and  $C = 0.68\mu F$  are used to insure that  $V_{IN}$  was >2.5V and the EN voltage was <400mV.

## Discharge Mode (Soft-Stop)

When a transition to shutdown mode occurs or the  $V_{IN}$  UVLO is set, the outputs discharge to GND through an internal 100 $\Omega$  switch.

## Power MOSFETs

The power MOSFETs are optimized for best efficiency. The ON-resistance for the P-MOSFET is typically 50m $\Omega$  and the ON-resistance for the N-MOSFET is typically 50m $\Omega$ .

## 100% Duty Cycle

The ISL8013A features 100% duty cycle operation to maximize the battery life. When the battery voltage drops to a level that the ISL8013A can no longer maintain the regulation at the output, the regulator completely turns on the P-MOSFET. The maximum dropout voltage under the 100% duty-cycle operation is the product of the load current and the ON-resistance of the P-MOSFET.

## Thermal Shutdown

The ISL8013A has built-in thermal protection. When the internal temperature reaches +140 $^{\circ}$ C, the regulator is completely shut down. As the temperature drops to +115 $^{\circ}$ C, the ISL8013A resumes operation by stepping through the soft-start.

## Applications Information

### Output Inductor and Capacitor Selection

To consider steady state and transient operations, ISL8013A typically uses a 1.5µH output inductor. The higher or lower inductor value can be used to optimize the total converter system performance. For example, for higher output voltage 3.3V application, in order to decrease the inductor current ripple and output voltage ripple, the output inductor value can be increased. It is recommended to set the ripple inductor current approximately 30% of the maximum output current for optimized performance. The inductor ripple current can be expressed as shown in [Equation 3](#):

$$\Delta I = \frac{V_O \cdot \left(1 - \frac{V_O}{V_{IN}}\right)}{L \cdot f_S} \quad (\text{EQ. 3})$$

The inductor's saturation current rating needs to be at least larger than the peak current. The ISL8013A protects the typical peak current 4.8A. The saturation current needs to be over 5.5A for maximum output current applications.

ISL8013A uses an internal compensation network and the output capacitor value is dependent on the output voltage. The ceramic capacitor is recommended to be X5R or X7R. The recommended X5R or X7R minimum output capacitor values are shown in [Table 1](#). In [Table 1](#), the minimum output capacitor value is given for the different output voltage to make sure that the whole converter system is stable. Additional output capacitance should be added for better performances in applications where high load transient or low output ripple is required. It is recommended to check the system level performance along with the simulation model.

TABLE 1. OUTPUT CAPACITOR VALUE vs V<sub>OUT</sub>

V <sub>OUT</sub> (V)	C <sub>OUT</sub> (µF)	L (µH)
0.8	2 x 22	1.0~2.2
1.2	2 x 22	1.0~2.2
1.5	2 x 22	1.5~3.3
1.8	2 x 22	1.5~3.3
2.5	2 x 22	1.5~3.3
3.3	2 x 22	2.2~4.7
3.6	2 x 22	2.2~4.7

### Output Voltage Selection

The output voltage of the regulator can be programmed via an external resistor divider that is used to scale the output voltage relative to the internal reference voltage and feed it back to the inverting input of the error amplifier (see [Figure 1](#)).

The output voltage programming resistor, R<sub>3</sub>, will depend on the value chosen for the feedback resistor and the desired output voltage of the regulator. The value for the feedback resistor is typically between 10kΩ and 100kΩ, as shown in [Equation 4](#).

$$R_3 = \frac{R_2 \cdot 0.8V}{V_{OUT} - 0.8V} \quad (\text{EQ. 4})$$

If the output voltage desired is 0.8V, then R<sub>3</sub> is left unpopulated and R<sub>2</sub> is shorted. There is a leakage current from VIN to LX. It is recommended to preload the output with 10µA minimum. For better performance, add 47pF in parallel with R<sub>2</sub> (100kΩ).

### Input Capacitor Selection

The main functions for the input capacitor are to provide decoupling of the parasitic inductance and to provide filtering function to prevent the switching current flowing back to the battery rail. Two 22µF X5R or X7R ceramic capacitors are a good starting point for the input capacitor selection.

## Revision History

The revision history provided is for informational purposes only and is believed to be accurate, but not warranted. Please go to web to make sure you have the latest Rev.

DATE	REVISION	CHANGE
November 17, 2014	FN7526.2	Added more information to section "Enable" on page 13. Added more information to section "UVLO" on page 13.
July 24, 2014	FN7526.1	Converted to new datasheet template. Updated Tape & Reel note in "Ordering Information" on page 2 from "Add "-T" suffix for tape and reel." to new standard "Add "-T*" suffix for tape and reel." The "*" covers all possible tape and reel options. Added Evaluation board information to the Ordering Information on page 2. Replaced Figure 6 on page 6, Figure 7 on page 6 and Figure 11 on page 7 with the new data curves. Removed Figure 9 (POWER DISSIPATION WITH NO LOAD vs VIN (PFM VOUT = 1.8V)).
November 25, 2009	FN7526.0	Initial Release.

## About Intersil

Intersil Corporation is a leading provider of innovative power management and precision analog solutions. The company's products address some of the largest markets within the industrial and infrastructure, mobile computing and high-end consumer markets.

For the most updated datasheet, application notes, related documentation and related parts, please see the respective product information page found at [www.intersil.com](http://www.intersil.com).

You may report errors or suggestions for improving this datasheet by visiting [www.intersil.com/ask](http://www.intersil.com/ask).

Reliability reports are also available from our website at [www.intersil.com/support](http://www.intersil.com/support)

For additional products, see [www.intersil.com/en/products.html](http://www.intersil.com/en/products.html)

Intersil products are manufactured, assembled and tested utilizing ISO9001 quality systems as noted in the quality certifications found at [www.intersil.com/en/support/qualandreliability.html](http://www.intersil.com/en/support/qualandreliability.html)

*Intersil products are sold by description only. Intersil Corporation reserves the right to make changes in circuit design, software and/or specifications at any time without notice. Accordingly, the reader is cautioned to verify that data sheets are current before placing orders. Information furnished by Intersil is believed to be accurate and reliable. However, no responsibility is assumed by Intersil or its subsidiaries for its use; nor for any infringements of patents or other rights of third parties which may result from its use. No license is granted by implication or otherwise under any patent or patent rights of Intersil or its subsidiaries.*

For information regarding Intersil Corporation and its products, see [www.intersil.com](http://www.intersil.com)

## Package Outline Drawing

### L16.4x4

16 LEAD QUAD FLAT NO-LEAD PLASTIC PACKAGE

Rev 6, 02/08

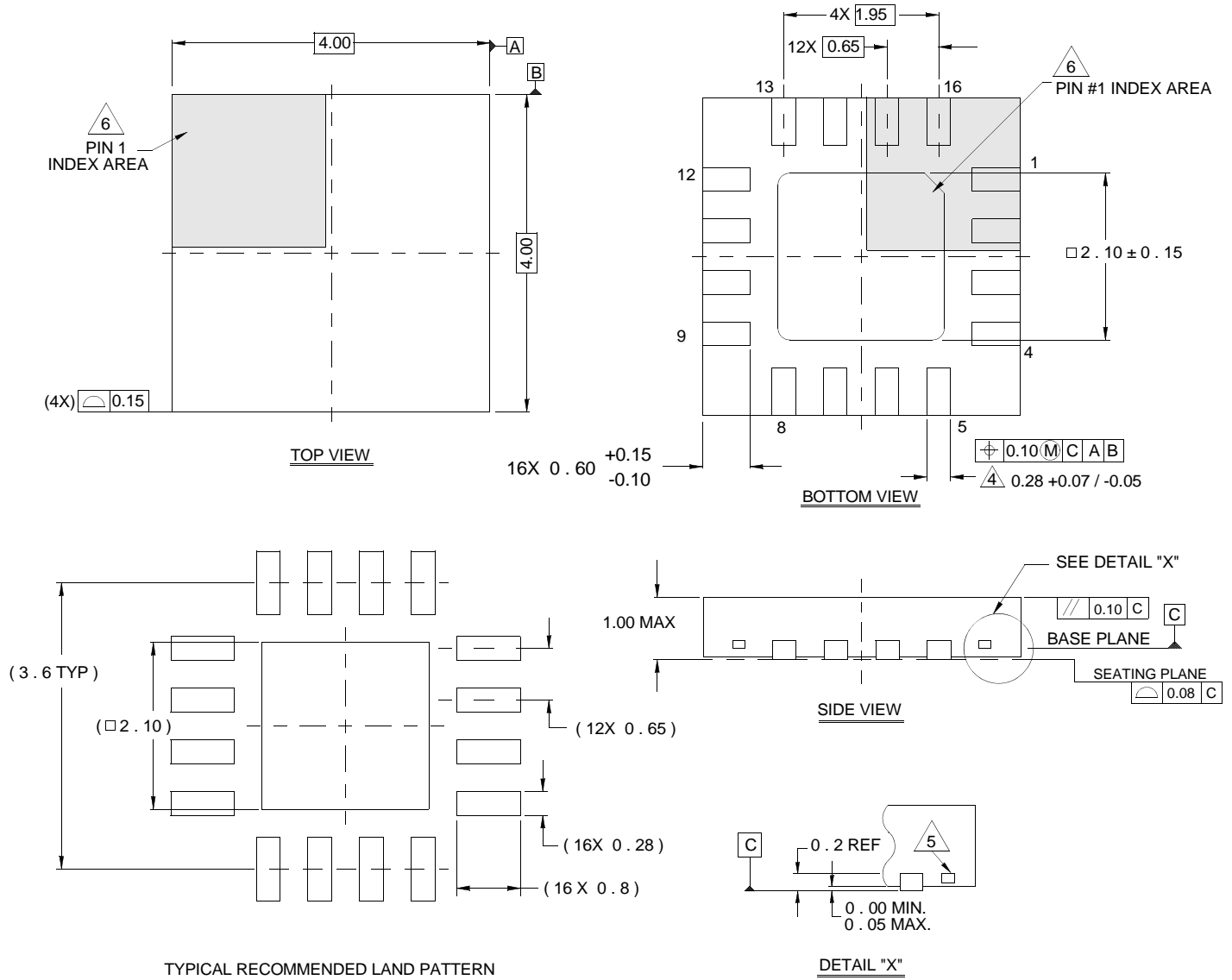

#### NOTES:

- Dimensions are in millimeters.  
Dimensions in ( ) for Reference Only.
- Dimensioning and tolerancing conform to AMSE Y14.5m-1994.
- Unless otherwise specified, tolerance : Decimal ± 0.05
- Dimension b applies to the metallized terminal and is measured between 0.15mm and 0.30mm from the terminal tip.
- Tiebar shown (if present) is a non-functional feature.
- The configuration of the pin #1 identifier is optional, but must be located within the zone indicated. The pin #1 identifier may be either a mold or mark feature.



# Mouser Electronics

Authorized Distributor

Click to View Pricing, Inventory, Delivery & Lifecycle Information:

[Intersil:](#)

[ISL8013AEVAL2Z](#) [ISL8013AIRZ](#) [ISL8013AIRZ-T](#) [ISL8013AIRZ-T7A](#)