

Linear Power MOSFET IXTH12N100L

With Extended FBSOA

N-Channel Enhancement Mode

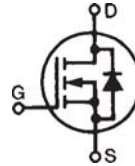

$$V_{DSS} = 1000 \text{ V}$$

$$I_{D25} = 12 \text{ A}$$

$$R_{DS(on)} \leq 1.3 \text{ } \Omega$$

Symbol	Test Conditions	Maximum Ratings	
V_{DSS}	$T_J = 25^\circ\text{C}$ to 150°C	1000	V
V_{DGR}	$T_J = 25^\circ\text{C}$ to 150°C ; $R_{GS} = 1 \text{ M}\Omega$	1000	V
V_{GS}	Continuous	± 30	V
V_{GSM}	Transient	± 40	V
I_{D25}	$T_C = 25^\circ\text{C}$	12	A
I_{DM}	$T_C = 25^\circ\text{C}$, pulse width limited by T_{JM}	25	A
I_{AR}	$T_C = 25^\circ\text{C}$	12	A
E_{AR}	$T_C = 25^\circ\text{C}$	30	mJ
E_{AS}		1.5	J
P_D	$T_C = 25^\circ\text{C}$	400	W
T_J		-55 to +150	$^\circ\text{C}$
T_{JM}		150	$^\circ\text{C}$
T_{stg}		-55 to +150	$^\circ\text{C}$
T_L	1.6 mm (0.063 in) from case for 10 s	300	$^\circ\text{C}$
T_{SOLD}	Plastic body for 10 s	260	$^\circ\text{C}$
M_d	Mounting torque	0.9/7.9	Nm/lb.in.
Weight	TO-247	6	g

TO-247 (IXTH)

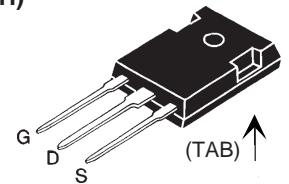

G = Gate D = Drain
S = Source TAB = Drain

Features

- Designed for linear operation
- International standard package
- Unclamped Inductive switching (UIS) rated
- Molding epoxies meet UL 94 V-0 flammability classification

Applications

- Programmable loads
- Current regulators
- DC-DC converters
- Battery chargers
- DC choppers
- Temperature and lighting controls

Advantages

- Easy to mount
- Space savings
- High power density

Symbol	Test Conditions	Characteristic Values ($T_J = 25^\circ\text{C}$, unless otherwise specified)		
		Min.	Typ.	Max.
BV_{DSS}	$V_{GS} = 0 \text{ V}$, $I_D = 250 \text{ } \mu\text{A}$	1000		V
$V_{GS(th)}$	$V_{DS} = V_{GS}$, $I_D = 250 \text{ } \mu\text{A}$	3		V
I_{GSS}	$V_{GS} = \pm 30 \text{ V}$, $V_{DS} = 0 \text{ V}$			$\pm 100 \text{ nA}$
I_{DSS}	$V_{DS} = V_{DSS}$ $V_{GS} = 0 \text{ V}$	$T_J = 25^\circ\text{C}$		50 μA
		$T_J = 125^\circ\text{C}$		500 μA
$R_{DS(on)}$	$V_{GS} = 20 \text{ V}$, $I_D = 0.5 I_{D25}$ Note 1			1.3 Ω

Symbol	Test Conditions	Characteristic Values			
		(T _J = 25°C, unless otherwise specified)			
		Min.	Typ.	Max.	
g_{fs}	V _{DS} = 10 V; I _D = 0.5 • I _{D25} , Note 1		5	S	
C_{iss}	V _{GS} = 0 V, V _{DS} = 25 V, f = 1 MHz		2500	pF	
C_{oss}			300	pF	
C_{rss}			95	pF	
t_{d(on)}	V _{GS} = 15 V, V _{DS} = 0.5 • V _{DSS} , I _D = 0.5 • I _{D25}		30	ns	
t_r			55	ns	
t_{d(off)}		R _G = 4.7 Ω (External),		110	ns
t_f				65	ns
Q_{g(on)}	V _{GS} = 20 V, V _{DS} = 0.5 • V _{DSS} , I _D = 0.5 • I _{D25}		155	nC	
Q_{gs}			35	nC	
Q_{gd}			55	nC	
R_{thJC}			0.31	°C/W	
R_{thCS}		0.25		°C/W	

Safe Operating Area Specification

Symbol	Test Conditions	Min.	Typ.	Max.
SOA	V _{DS} = 800 V, I _D = 0.25A, T _C = 60°C	200		W

Source-Drain Diode

Symbol	Test Conditions	Characteristic Values		
		(T _J = 25°C, unless otherwise specified)		
		Min.	Typ.	Max.
I_S	V _{GS} = 0 V			12 A
I_{SM}	Repetitive; pulse width limited by T _{JM}			48 A
V_{SD}	I _F = I _S , V _{GS} = 0 V, Note 1			1.5 V
t_{rr}	I _F = I _S , -di/dt = 100 A/μs, V _R = 100V		1000	ns

Note 1: Pulse test, t ≤ 300 μs, duty cycle, d ≤ 2 %

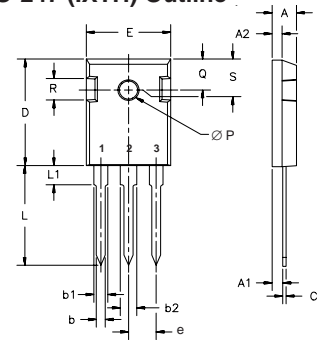
TO-247 (IXTH) Outline

Terminals: 1 - Gate
3 - Source
2 - Drain Tab - Drain

Dim.	Millimeter		Inches	
	Min.	Max.	Min.	Max.
A	4.7	5.3	.185	.209
A ₁	2.2	2.54	.087	.102
A ₂	2.2	2.6	.059	.098
b	1.0	1.4	.040	.055
b ₁	1.65	2.13	.065	.084
b ₂	2.87	3.12	.113	.123
C	.4	.8	.016	.031
D	20.80	21.46	.819	.845
E	15.75	16.26	.610	.640
e	5.20	5.72	0.205	0.225
L	19.81	20.32	.780	.800
L1		4.50		.177
∅P	3.55	3.65	.140	.144
Q	5.89	6.40	0.232	0.252
R	4.32	5.49	.170	.216
S	6.15	BSC	242	BSC

PRELIMINARY TECHNICAL INFORMATION

The product presented herein is under development. The Technical Specifications offered are derived from data gathered during objective characterizations of preliminary engineering lots; but also may yet contain some information supplied during a pre-production design evaluation. IXYS reserves the right to change limits, test conditions, and dimensions without notice.

IXYS reserves the right to change limits, test conditions, and dimensions.

IXYS MOSFETs and IGBTs are covered by one or more of the following U.S. patents:

4,835,592	4,931,844	5,049,961	5,237,481	6,162,665	6,404,065 B1	6,683,344	6,727,585	7,005,734 B2	7,157,338B2
4,850,072	5,017,508	5,063,307	5,381,025	6,259,123 B1	6,534,343	6,710,405 B2	6,759,692	7,063,975 B2	
4,881,106	5,034,796	5,187,117	5,486,715	6,306,728 B1	6,583,505	6,710,463	6,771,478 B2	7,071,537	

Fig. 1. Output Characteristics @ 25°C

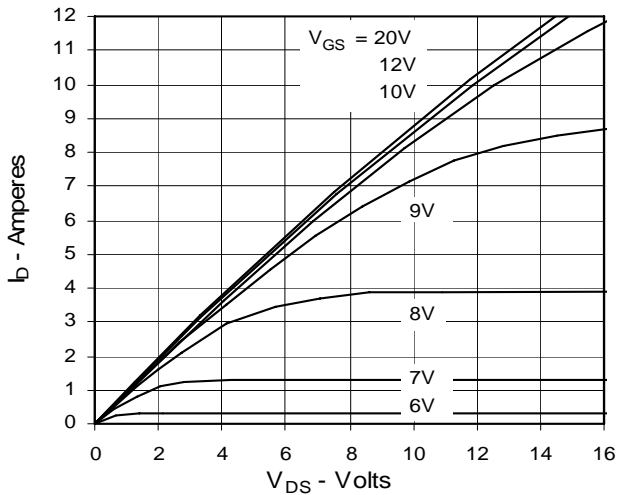

Fig. 2. Extended Output Characteristics @ 25°C

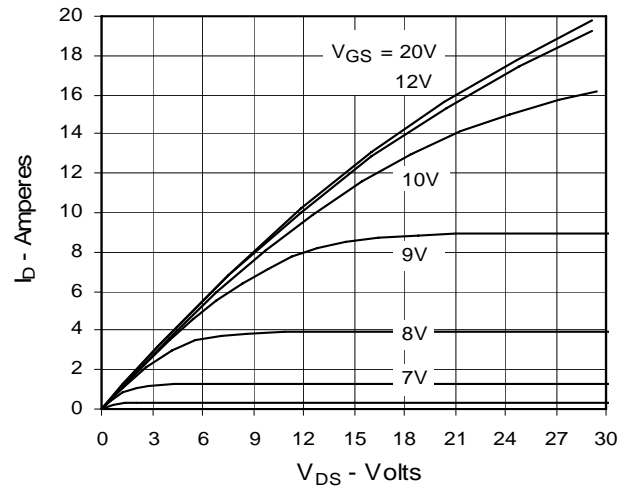

Fig. 3. Output Characteristics @ 125°C

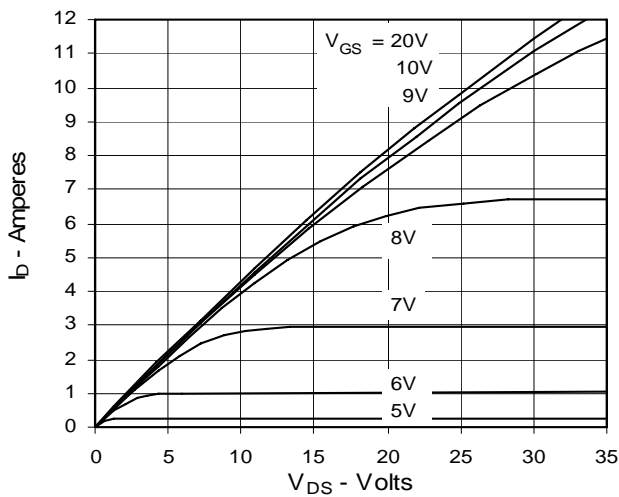

Fig. 4. $R_{DS(on)}$ Normalized to 0.5 I_{D25} Value vs. Junction Temperature

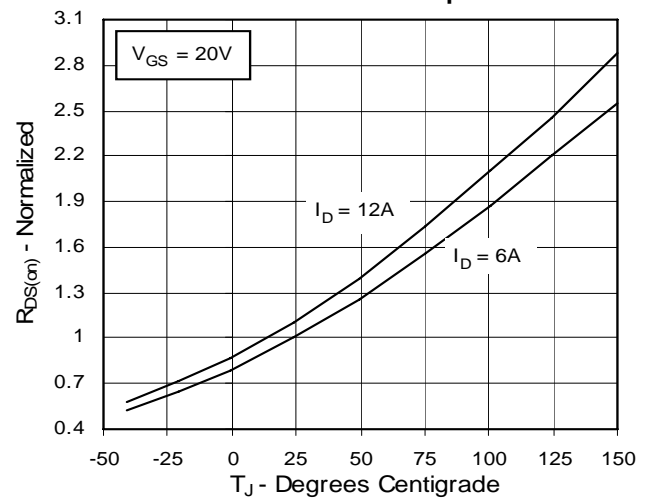

Fig. 5. $R_{DS(on)}$ Normalized to 0.5 I_{D25} Value vs. I_D

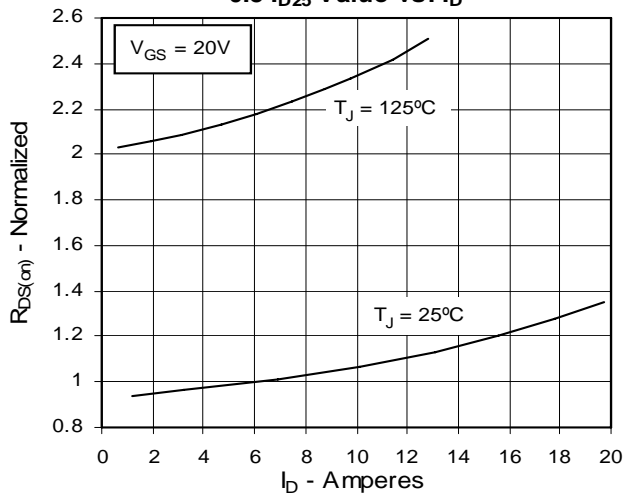

Fig. 6. Drain Current vs. Case Temperature

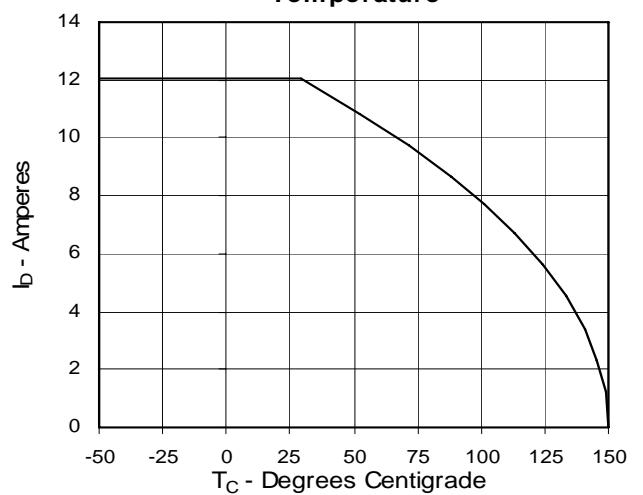

Fig. 7. Input Admittance

Fig. 8. Transconductance

Fig. 9. Source Current vs. Source-To-Drain Voltage

Fig. 10. Gate Charge

Fig. 11. Capacitance

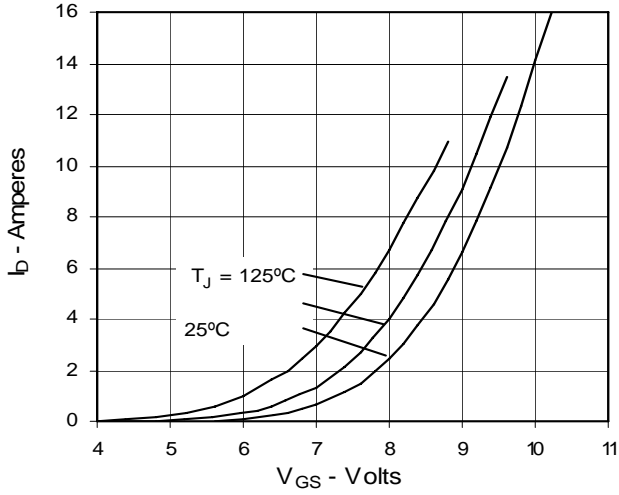
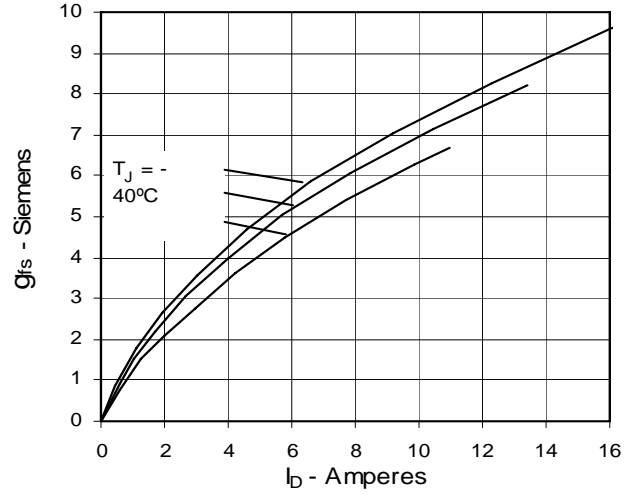
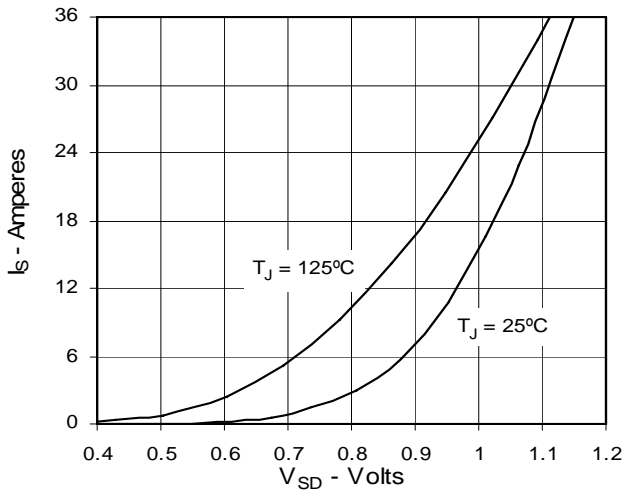
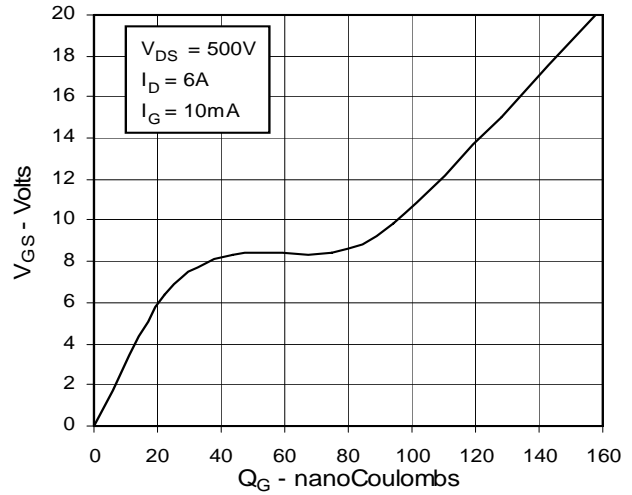
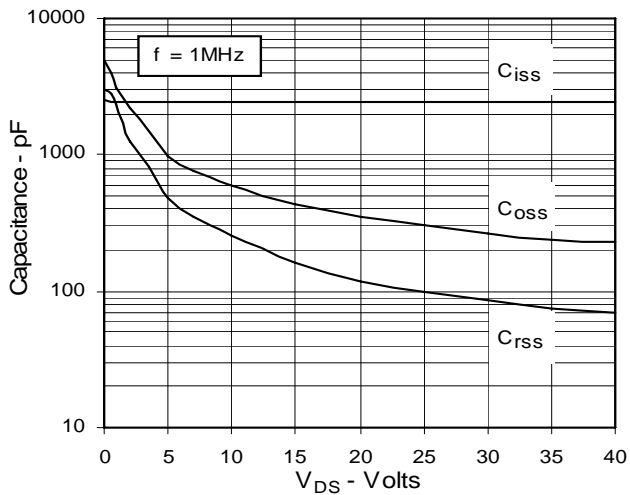
Fig. 12. Forward-Bias Safe Operating Area @ $T_C = 25^\circ\text{C}$

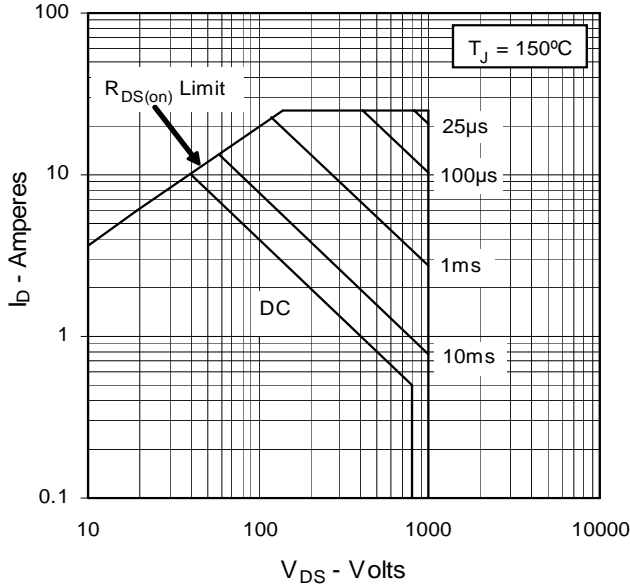

Fig. 13. Forward-Bias Safe Operating Area @ $T_C = 60^\circ\text{C}$

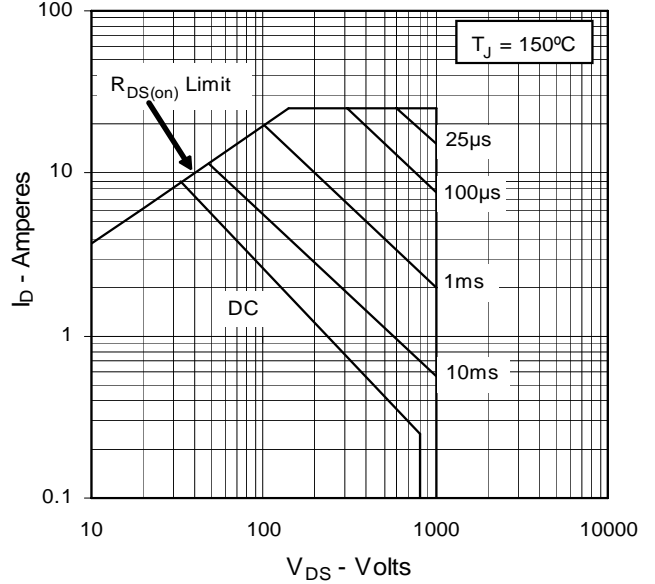
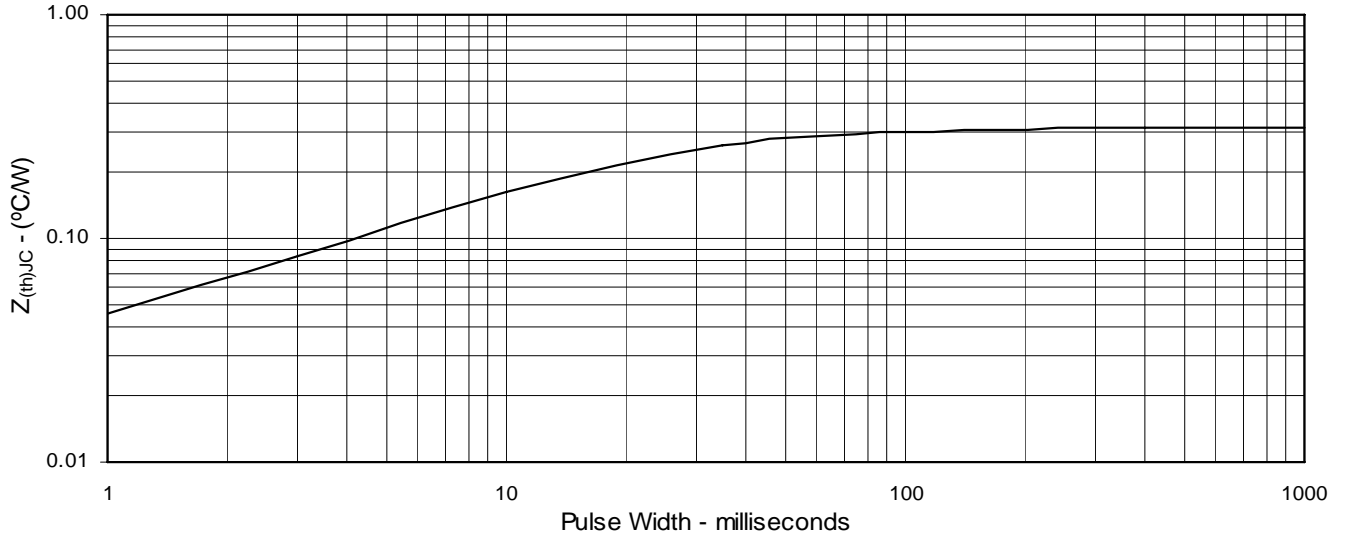

Fig. 14. Maximum Transient Thermal Impedance



Mouser Electronics

Authorized Distributor

Click to View Pricing, Inventory, Delivery & Lifecycle Information:

[IXYS:](#)

[IXTH12N100L](#)