

**GenX3™ A3-Class  
IGBTs**
**IXGK120N120A3  
IXGX120N120A3**

$$V_{CES} = 1200V$$

$$I_{C110} = 120A$$

$$V_{CE(sat)} \leq 2.20V$$

 Ultra-Low V<sub>sat</sub> PT IGBTs for  
up to 3kHz Switching

Symbol	Test Conditions	Maximum Ratings	
$V_{CES}$	$T_J = 25^\circ C$ to $150^\circ C$	1200	V
$V_{CGR}$	$T_J = 25^\circ C$ to $150^\circ C$ , $R_{GE} = 1M\Omega$	1200	V
$V_{GES}$	Continuous	$\pm 20$	V
$V_{GEM}$	Transient	$\pm 30$	V
$I_{C25}$	$T_C = 25^\circ C$ ( Chip Capability )	240	A
$I_{C110}$	$T_C = 110^\circ C$	120	A
$I_{LRMS}$	Terminal Current Limit	75	A
$I_{CM}$	$T_C = 25^\circ C$ , 1ms	600	A
<b>SSOA</b> <b>(RBSOA)</b>	$V_{GE} = 15V$ , $T_{VJ} = 125^\circ C$ , $R_G = 1\Omega$ Clamped Inductive Load	$I_{CM} = 240$ @ $0.8 \cdot V_{CES}$	A
$P_C$	$T_C = 25^\circ C$	830	W
$T_J$		-55 ... +150	$^\circ C$
$T_{JM}$		150	$^\circ C$
$T_{stg}$		-55 ... +150	$^\circ C$
$T_L$	Maximum Lead Temperature for Soldering	300	$^\circ C$
$T_{SOLD}$	1.6 mm (0.062 in.) from Case for 10	260	$^\circ C$
$M_d$	Mounting Torque ( IXGK )	1.13/10	Nm/lb.in.
$F_C$	Mounting Force ( IXGX )	20..120/4.5..27	N/lb.
<b>Weight</b>	TO-264	10	g
	PLUS247	6	g

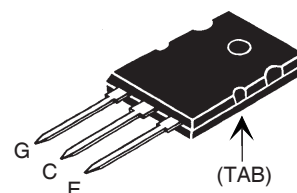
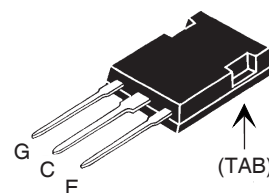
**TO-264 (IXGK)**

**PLUS 247™ (IXGX)**

G = Gate                      E = Emitter  
C = Collector                TAB = Collector

**Features**

- Optimized for Low Conduction Losses
- Square RBSOA
- High Avalanche Capability
- International Standard Packages

**Advantages**

- High Power Density
- Low Gate Drive Requirement

**Applications**

- Power Inverters
- UPS
- Motor Drives
- SMPS
- PFC Circuits
- Battery Chargers
- Welding Machines
- Lamp Ballasts
- Inrush Current Protection Circuits

Symbol	Test Conditions ( $T_J = 25^\circ C$ , Unless Otherwise Specified)	Characteristic Values		
		Min.	Typ.	Max.
$BV_{CES}$	$I_C = 250\mu A$ , $V_{CE} = 0V$	1200		V
$V_{GE(th)}$	$I_C = 1mA$ , $V_{CE} = V_{GE}$	3.0		5.0 V
$I_{CES}$	$V_{CE} = V_{CES}$ , $V_{GE} = 0V$ $T_J = 125^\circ C$			50 $\mu A$ 3 mA
$I_{GES}$	$V_{CE} = 0V$ , $V_{GE} = \pm 20V$			$\pm 400$ nA
$V_{CE(sat)}$	$I_C = 100A$ , $V_{GE} = 15V$ , Note 1	1.85	2.20	V

Symbol	Test Conditions ( $T_J = 25^\circ\text{C}$ , Unless Otherwise Specified)	Characteristic Values		
		Min.	Typ.	Max.
$g_{fs}$	$I_C = 60\text{A}, V_{CE} = 10\text{V}$ , Note 1	45	73	S
$C_{ies}$	$V_{CE} = 25\text{V}, V_{GE} = 0\text{V}, f = 1\text{MHz}$		9900	pF
$C_{oes}$			655	pF
$C_{res}$			240	pF
$Q_{g(on)}$	$I_C = I_{C110}, V_{GE} = 15\text{V}, V_{CE} = 0.5 \cdot V_{CES}$		420	nC
$Q_{ge}$			70	nC
$Q_{gc}$			180	nC
$t_{d(on)}$	<b>Inductive load, <math>T_J = 25^\circ\text{C}</math></b>  $I_C = 100\text{A}, V_{GE} = 15\text{V}$ $V_{CE} = 960\text{V}, R_G = 1\Omega$ Note 2		40	ns
$t_{ri}$			67	ns
$E_{on}$			10	mJ
$t_{d(off)}$			490	ns
$t_{fi}$			325	ns
$E_{off}$		33	mJ	
$t_{d(on)}$	<b>Inductive load, <math>T_J = 125^\circ\text{C}</math></b>  $I_C = 100\text{A}, V_{GE} = 15\text{V}$ $V_{CE} = 960\text{V}, R_G = 1\Omega$ Note 2		30	ns
$t_{ri}$			75	ns
$E_{on}$			15	mJ
$t_{d(off)}$			685	ns
$t_{fi}$			680	ns
$E_{off}$		58	mJ	
$R_{thJC}$			0.15	$^\circ\text{C/W}$
$R_{thCK}$		0.15		$^\circ\text{C/W}$

Note 1: Pulse Test,  $t \leq 300\mu\text{s}$ , Duty Cycle,  $d \leq 2\%$ .  
 2. Switching Times may Increase for  $V_{CE} \text{ (Clamp)} > 0.8 V_{CES}$ , Higher  $T_J$  or Increased  $R_G$ .

### PRELIMINARY TECHNICAL INFORMATION

The product presented herein is under development. The Technical Specifications offered are derived from data gathered during objective characterizations of preliminary engineering lots; but also may yet contain some information supplied during a pre-production design evaluation. IXYS reserves the right to change limits, test conditions, and dimensions without notice.

IXYS Reserves the Right to Change Limits, Test Conditions, and Dimensions.

IXYS MOSFETs and IGBTs are covered 4,835,592 4,931,844 5,049,961 5,237,481 6,162,665 6,404,065 B1 6,683,344 6,727,585 7,005,734 B2 7,157,338B2  
 by one or more of the following U.S. patents: 4,850,072 5,017,508 5,063,307 5,381,025 6,259,123 B1 6,534,343 6,710,405 B2 6,759,692 7,063,975 B2  
 4,881,106 5,034,796 5,187,117 5,486,715 6,306,728 B1 6,583,505 6,710,463 6,771,478 B2 7,071,537

### TO-264 (IXGK) Outline

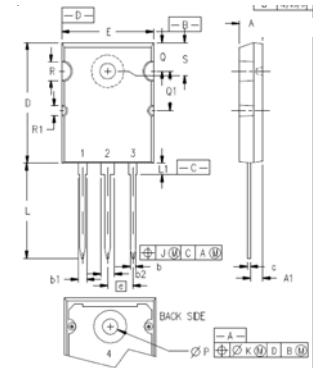

1 - GATE  
 2, 4 - DRAIN (COLLECTOR)  
 3 - SOURCE (EMITTER)

SYM	INCHES		MILLIMETERS	
	MIN	MAX	MIN	MAX
A	.185	.209	4.70	5.31
A1	.102	.118	2.59	3.00
b	.037	.055	0.94	1.40
b1	.087	.102	2.21	2.59
b2	.110	.126	2.79	3.20
c	.017	.029	0.43	0.74
D	1.007	1.047	25.58	26.59
E	.760	.799	19.30	20.29
e	.215 BSC		5.46 BSC	
J	.000	.010	0.00	0.25
K	.000	.010	0.00	0.25
L	.779	.842	19.79	21.39
L1	.087	.102	2.21	2.59
$\varnothing P$	.122	.138	3.10	3.51
Q	.240	.256	6.10	6.50
Q1	.330	.346	8.38	8.79
$\varnothing R$	.155	.187	3.94	4.75
$\varnothing R1$	.085	.093	2.16	2.36
S	.243	.253	6.17	6.43

### PLUS 247™ (IXGX) Outline

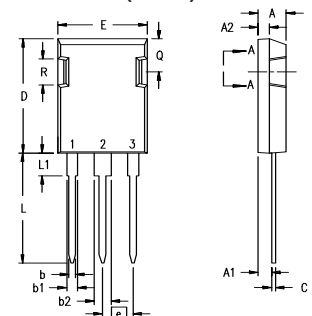

Terminals: 1 - Gate  
 2 - Drain (Collector)  
 3 - Source (Emitter)

Dim.	Millimeter		Inches	
	Min.	Max.	Min.	Max.
A	4.83	5.21	.190	.205
A <sub>1</sub>	2.29	2.54	.090	.100
A <sub>2</sub>	1.91	2.16	.075	.085
b	1.14	1.40	.045	.055
b <sub>1</sub>	1.91	2.13	.075	.084
b <sub>2</sub>	2.92	3.12	.115	.123
C	0.61	0.80	.024	.031
D	20.80	21.34	.819	.840
E	15.75	16.13	.620	.635
e	5.45 BSC		.215 BSC	
L	19.81	20.32	.780	.800
L1	3.81	4.32	.150	.170
Q	5.59	6.20	.220	0.244
R	4.32	4.83	.170	.190

**Fig. 1. Output Characteristics @ 25°C**

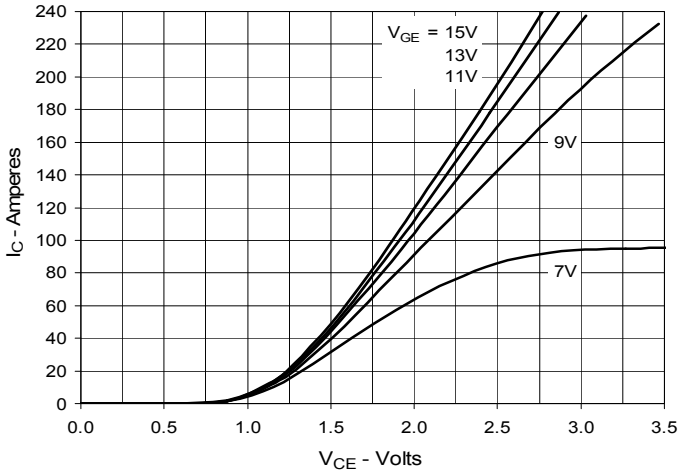

**Fig. 2. Extended Output Characteristics @ 25°C**

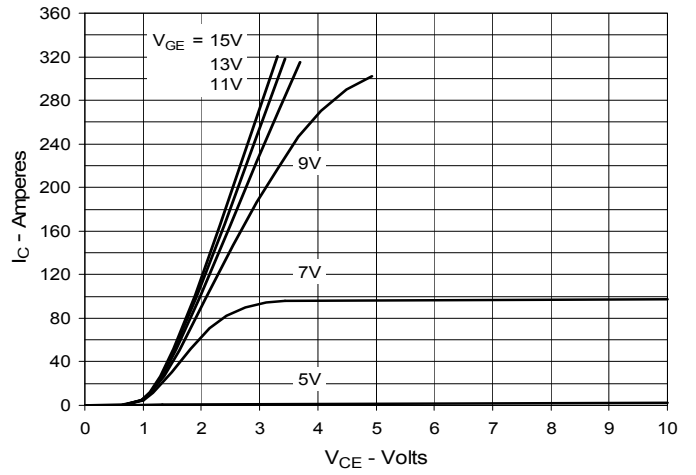

**Fig. 3. Output Characteristics @ 125°C**

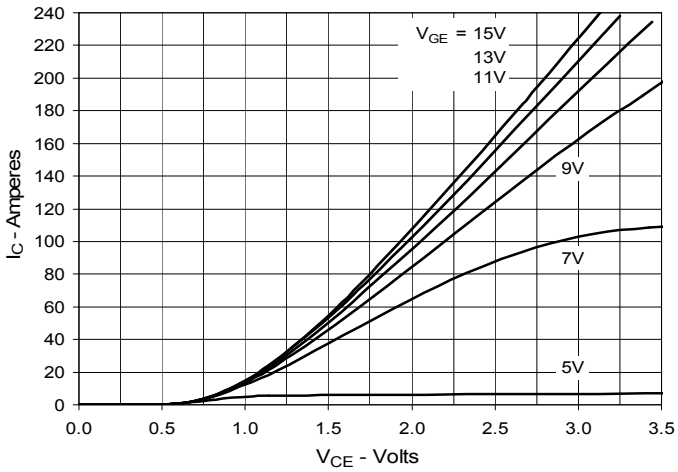

**Fig. 4. Dependence of  $V_{CE(sat)}$  on Junction Temperature**

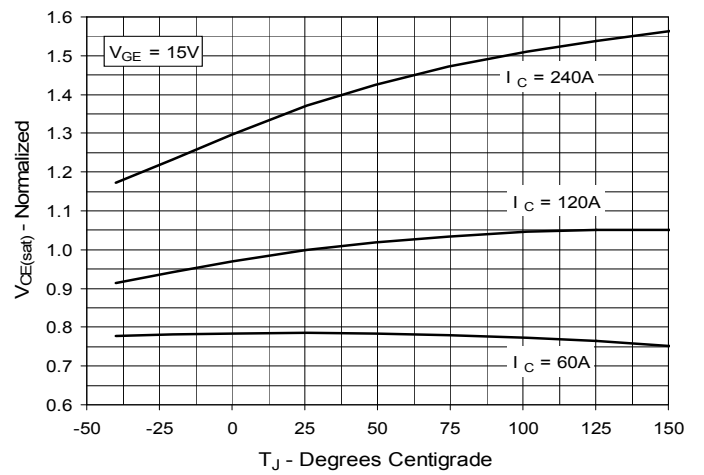

**Fig. 5. Collector-to-Emitter Voltage vs. Gate-to-Emitter Voltage**

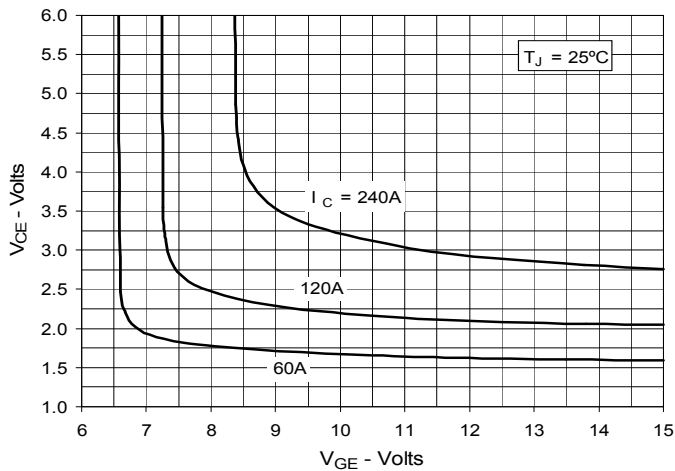

**Fig. 6. Input Admittance**

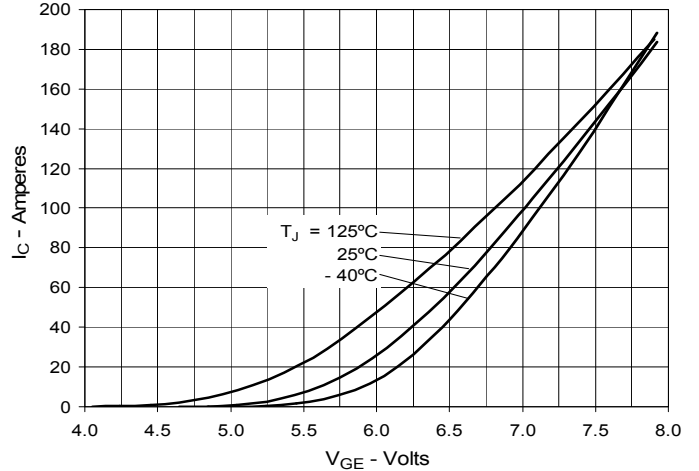

**Fig. 7. Transconductance**

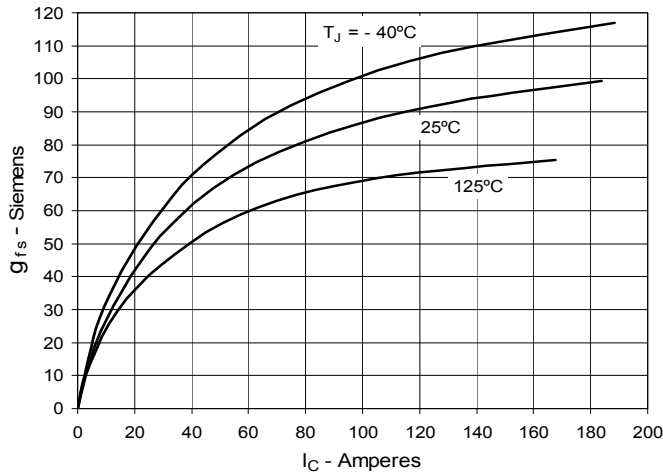

**Fig. 8. Gate Charge**

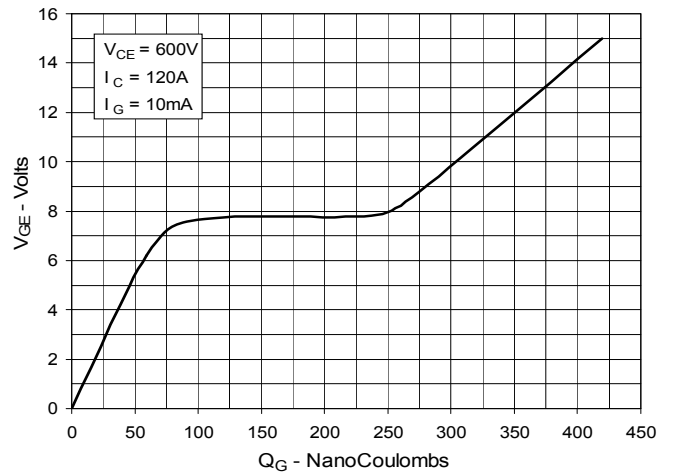

**Fig. 9. Capacitance**

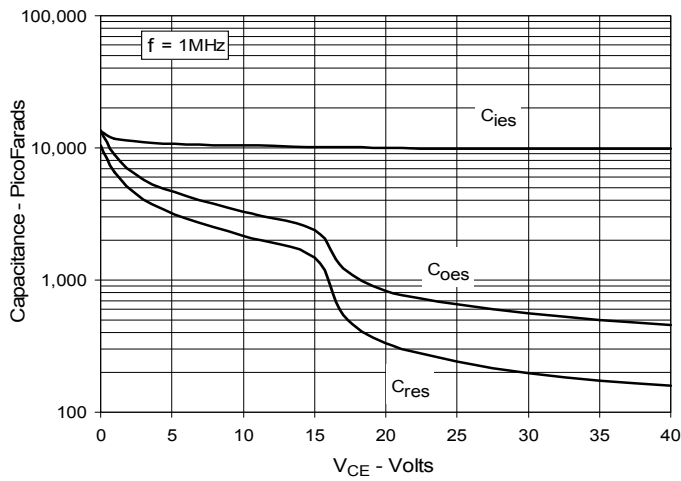

**Fig. 10. Reverse-Bias Safe Operating Area**

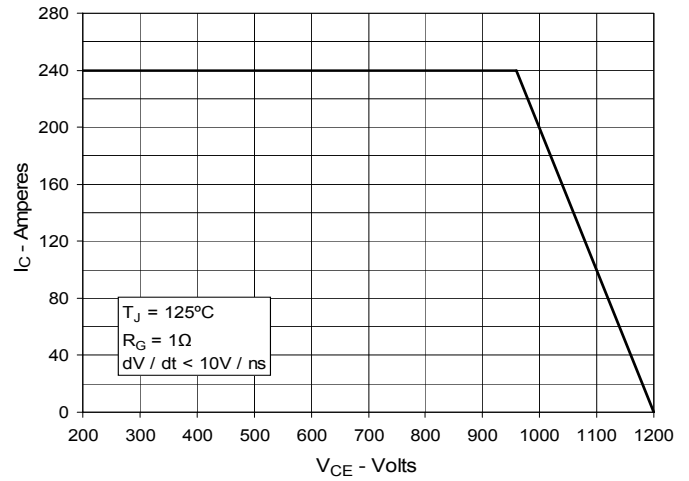

**Fig. 11. Maximum Transient Thermal Impedance**

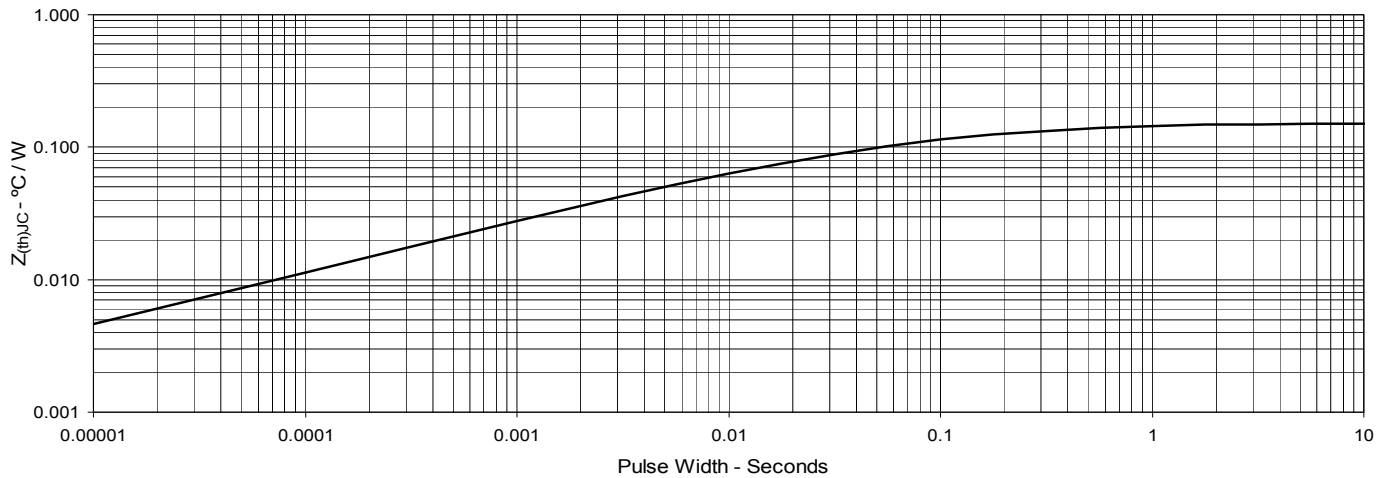

**Fig. 12. Inductive Switching Energy Loss vs. Gate Resistance**

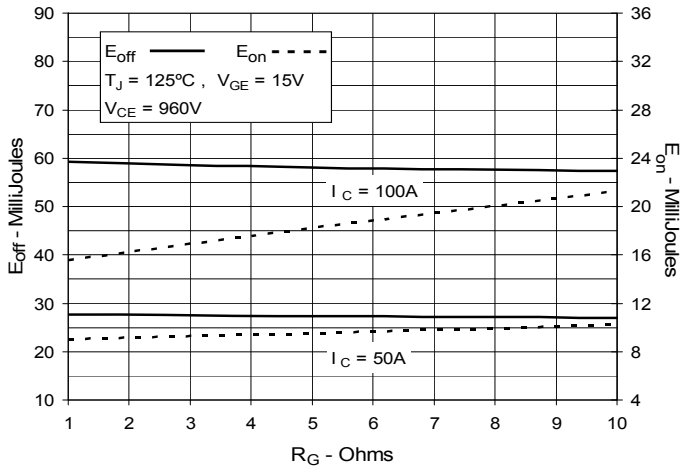

**Fig. 13. Inductive Switching Energy Loss vs. Collector Current**

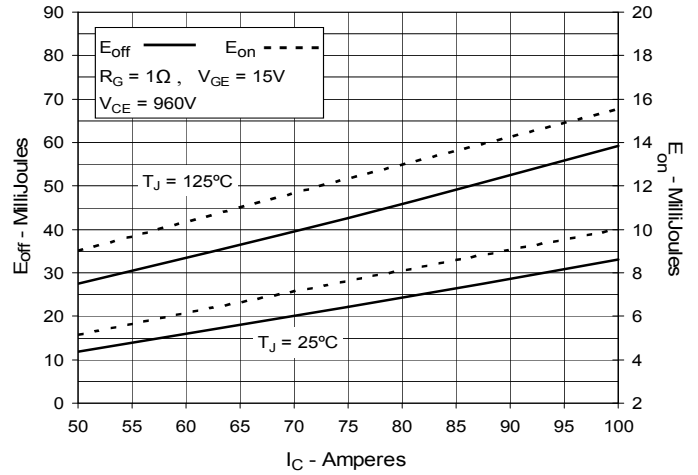

**Fig. 14. Inductive Switching Energy Loss vs. Junction Temperature**

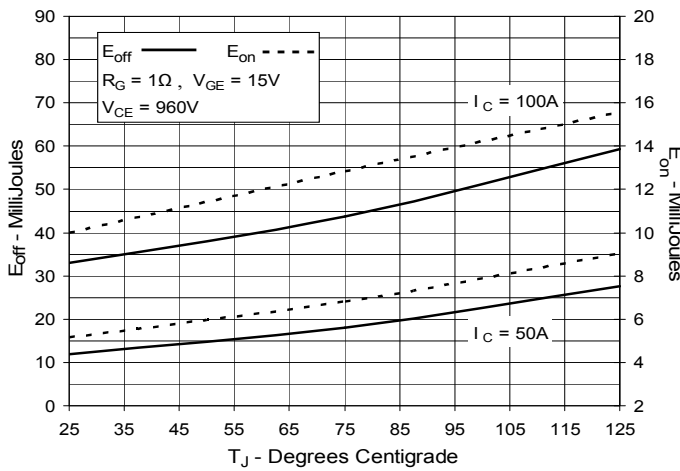

**Fig. 15. Inductive Turn-off Switching Times vs. Gate Resistance**

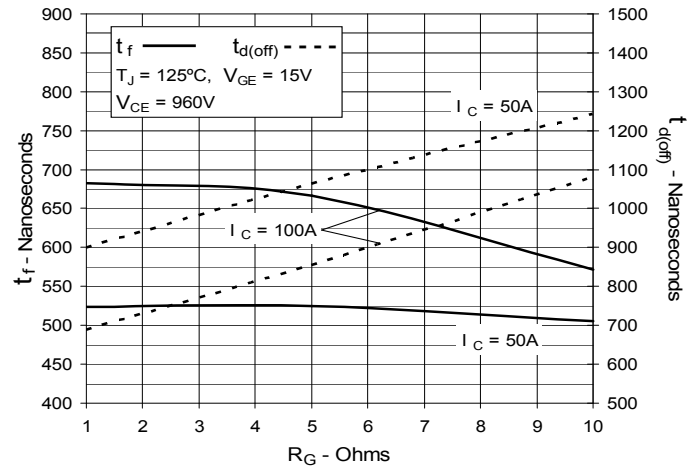

**Fig. 16. Inductive Turn-off Switching Times vs. Collector Current**

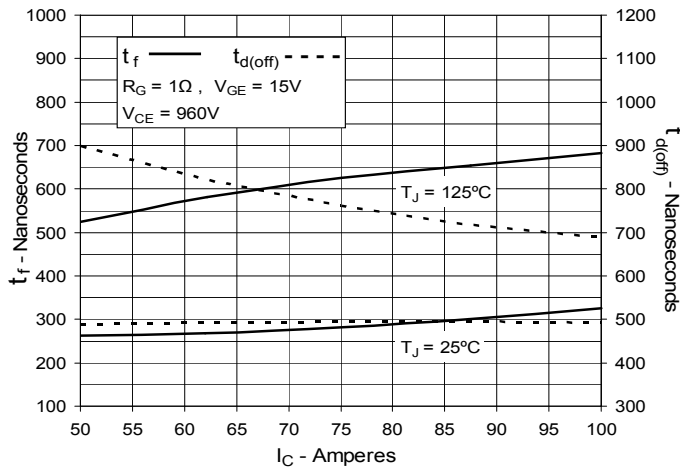

**Fig. 17. Inductive Turn-off Switching Times vs. Junction Temperature**

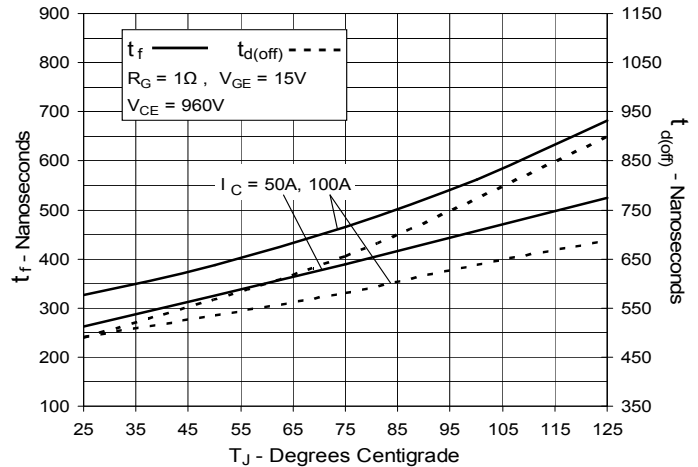

**Fig. 18. Inductive Turn-on  
Switching Times vs. Gate Resistance**

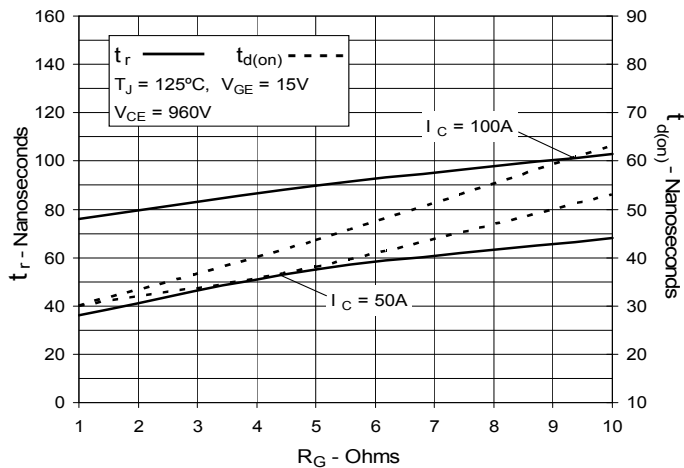

**Fig. 19. Inductive Turn-on  
Switching Times vs. Collector Current**

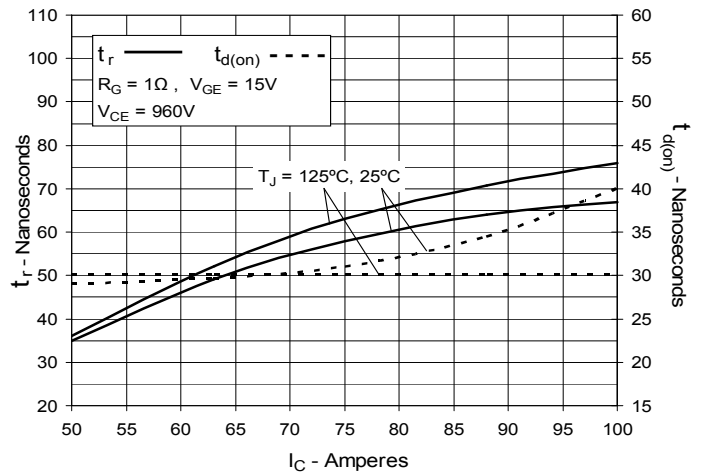

**Fig. 20. Inductive Turn-on  
Switching Times vs. Junction Temperature**

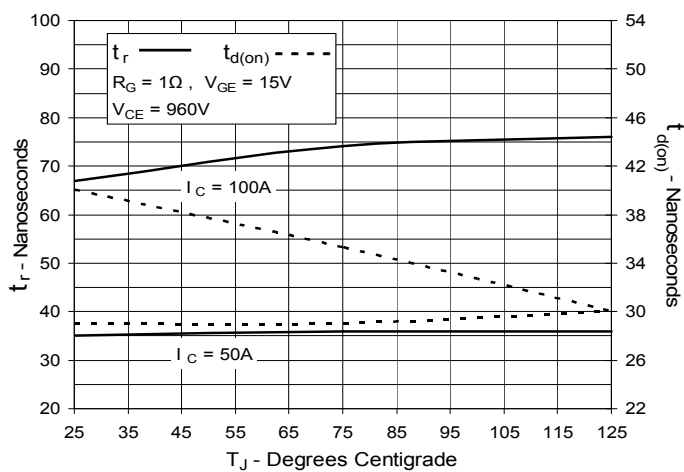

# Mouser Electronics

Authorized Distributor

Click to View Pricing, Inventory, Delivery & Lifecycle Information:

[IXYS:](#)

[IXGX120N120A3](#) [IXGK120N120A3](#)