

PolarP™ Power MOSFET

IXTR16P60P

$V_{DSS} = -600V$
 $I_{D25} = -10A$
 $R_{DS(on)} \leq 790m\Omega$

P-Channel Enhancement Mode
Avalanche Rated

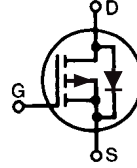

ISOPLUS247
E153432

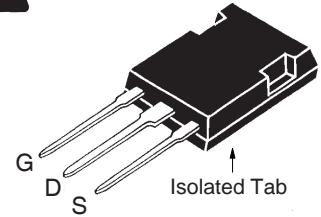

G = Gate D = Drain
S = Source

Symbol	Test Conditions	Maximum Ratings	
V_{DSS}	$T_J = 25^\circ C$ to $150^\circ C$	- 600	V
V_{DGR}	$T_J = 25^\circ C$ to $150^\circ C$, $R_{GS} = 1M\Omega$	- 600	V
V_{GSS}	Continuous	± 20	V
V_{GSM}	Transient	± 30	V
I_{D25}	$T_C = 25^\circ C$	- 10	A
I_{DM}	$T_C = 25^\circ C$, Pulse Width Limited by T_{JM}	- 48	A
I_A	$T_C = 25^\circ C$	- 16	A
E_{AS}	$T_C = 25^\circ C$	2.5	J
dV/dt	$I_S \leq I_{DM}$, $V_{DD} \leq V_{DSS}$, $T_J \leq 150^\circ C$	10	V/ns
P_D	$T_C = 25^\circ C$	190	W
T_J		-55 ... +150	$^\circ C$
T_{JM}		150	$^\circ C$
T_{stg}		-55 ... +150	$^\circ C$
T_L	1.6mm (0.062 in.) from Case for 10s	300	$^\circ C$
T_{SOLD}	Plastic Body for 10s	260	$^\circ C$
V_{ISOL}	50/60 Hz, 1 Minute	2500	V~
F_C	Mounting Force	20..120/4.5..27	N/lb.
Weight		5	g

Features

- Silicon Chip on Direct-Copper Bond (DCB) Substrate
- Isolated Mounting Surface
- 2500V~ Electrical Isolation
- Avalanche Rated
- Fast Intrinsic Rectifier
- Low $R_{DS(ON)}$ and Q_G

Advantages

- Easy to Mount
- Space Savings
- High Power Density

Applications

- High-Side Switches
- Push-Pull Amplifiers
- DC Choppers
- Automatic Test Equipment
- Load-Switch Applications
- Fuel Injection Systems

Symbol	Test Conditions ($T_J = 25^\circ C$, Unless Otherwise Specified)	Characteristic Values		
		Min.	Typ.	Max.
BV_{DSS}	$V_{GS} = 0V$, $I_D = -250\mu A$	- 600		V
$V_{GS(th)}$	$V_{DS} = V_{GS}$, $I_D = -250\mu A$	- 2.0		- 4.0 V
I_{GSS}	$V_{GS} = \pm 20V$, $V_{DS} = 0V$			± 100 nA
I_{DSS}	$V_{DS} = V_{DSS}$, $V_{GS} = 0V$ $T_J = 125^\circ C$			- 25 μA - 200 μA
$R_{DS(on)}$	$V_{GS} = -10V$, $I_D = -8A$, Note 1			790 m Ω

Symbol	Test Conditions ($T_J = 25^\circ\text{C}$, Unless Otherwise Specified)	Characteristic Values		
		Min.	Typ.	Max.
g_{fs}	$V_{DS} = -10\text{V}$, $I_D = -8\text{A}$, Note 1	11	18	S
C_{iss}	$V_{GS} = 0\text{V}$, $V_{DS} = -25\text{V}$, $f = 1\text{MHz}$		5120	pF
C_{oss}			445	pF
C_{rss}			60	pF
$t_{d(on)}$	Resistive Switching Times $V_{GS} = -10\text{V}$, $V_{DS} = 0.5 \cdot V_{DSS}$, $I_D = -8\text{A}$ $R_G = 3\Omega$ (External)		29	ns
t_r			25	ns
$t_{d(off)}$			60	ns
t_f			38	ns
$Q_{g(on)}$	$V_{GS} = -10\text{V}$, $V_{DS} = 0.5 \cdot V_{DSS}$, $I_D = -8\text{A}$		92	nC
Q_{gs}			27	nC
Q_{gd}			23	nC
R_{thJC}			0.66	$^\circ\text{C/W}$
R_{thCS}		0.15		$^\circ\text{C/W}$

Source-Drain Diode

Symbol	Test Conditions ($T_J = 25^\circ\text{C}$, Unless Otherwise Specified)	Characteristic Values		
		Min.	Typ.	Max.
I_s	$V_{GS} = 0\text{V}$			- 16 A
I_{SM}	Repetitive, Pulse Width Limited by T_{JM}			- 64 A
V_{SD}	$I_F = -8\text{A}$, $V_{GS} = 0\text{V}$, Note 1			- 2.8 V
t_{rr}	$I_F = -8\text{A}$, $-di/dt = -150\text{A}/\mu\text{s}$ $V_R = -100\text{V}$, $V_{GS} = 0\text{V}$		440	ns
Q_{RM}			7.4	μC
I_{RM}			- 33.6	A

Note 1: Pulse test, $t \leq 300\mu\text{s}$, duty cycle, $d \leq 2\%$.

ISOPLUS247 (IXTR) Outline



SYM	INCHES		MILLIMETERS	
	MIN	MAX	MIN	MAX
A	.190	.205	4.83	5.21
A1	.090	.100	2.29	2.54
A2	.075	.085	1.91	2.16
b	.045	.055	1.14	1.40
b1	.075	.085	1.91	2.15
b2	.115	.126	2.92	3.20
C	.024	.033	0.61	0.83
D	.819	.840	20.80	21.34
E	.620	.635	15.75	16.13
e	.215 BSC		5.45 BSC	
L	.780	.811	19.81	20.60
L1	.150	.172	3.81	4.38
Q	.220	.244	5.59	6.20
R	.170	.191	4.32	4.85
S	.520	.540	13.21	13.72
T	.620	.640	15.75	16.26
U	.065	.080	1.65	2.03
W	0	.004	0	0.10

IXYS Reserves the Right to Change Limits, Test Conditions, and Dimensions.

IXYS MOSFETs and IGBTs are covered by one or more of the following U.S. patents:	4,835,592	4,931,844	5,049,961	5,237,481	6,162,665	6,404,065 B1	6,683,344	6,727,585	7,005,734 B2	7,157,338B2
	4,860,072	5,017,508	5,063,307	5,381,025	6,259,123 B1	6,534,343	6,710,405 B2	6,759,692	7,063,975 B2	
	4,881,106	5,034,796	5,187,117	5,486,715	6,306,728 B1	6,583,505	6,710,463	6,771,478 B2	7,071,537	

Fig. 1. Output Characteristics @ $T_J = 25^\circ\text{C}$

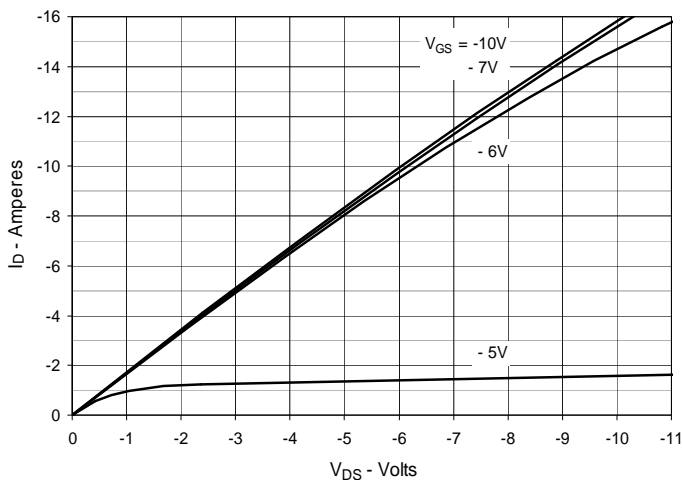

Fig. 2. Extended Output Characteristics @ $T_J = 25^\circ\text{C}$

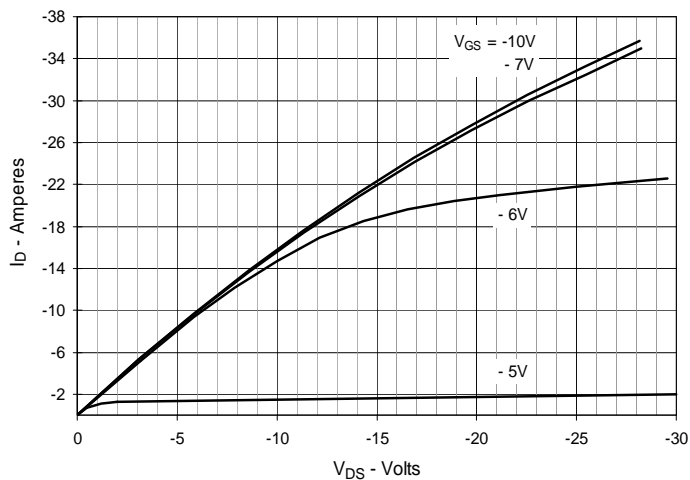

Fig. 3. Output Characteristics @ $T_J = 125^\circ\text{C}$

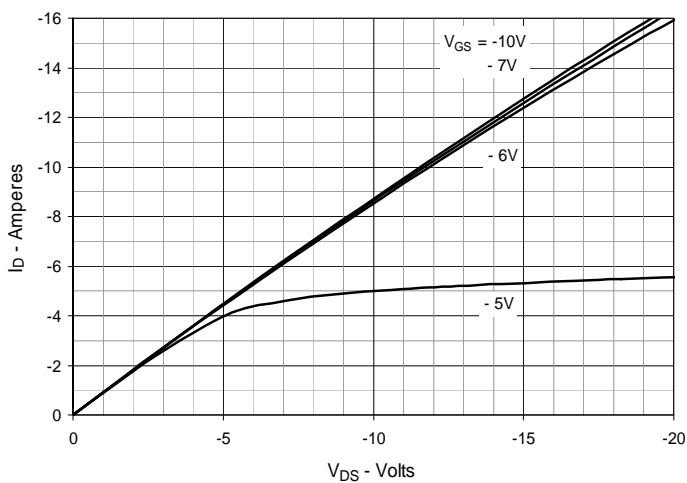

Fig. 4. $R_{DS(on)}$ Normalized to $I_D = -8\text{A}$ Value vs. Junction Temperature

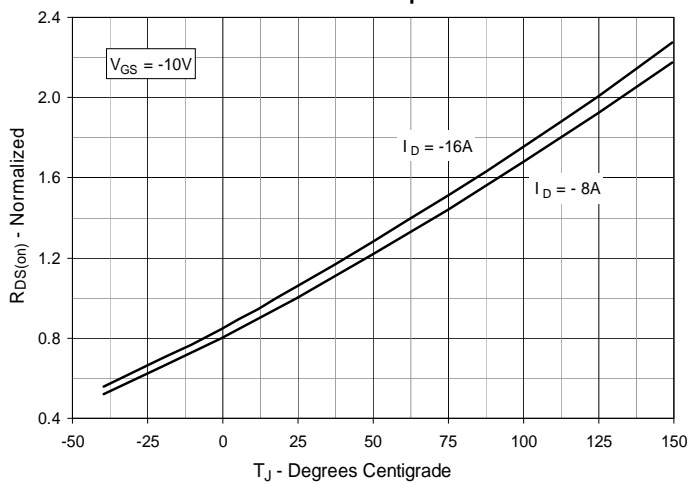

Fig. 5. $R_{DS(on)}$ Normalized to $I_D = -8\text{A}$ Value vs. Drain Current

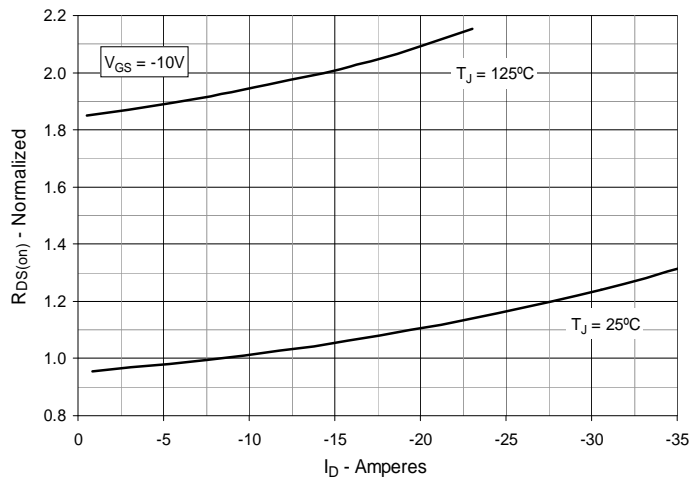

Fig. 6. Maximum Drain Current vs. Case Temperature

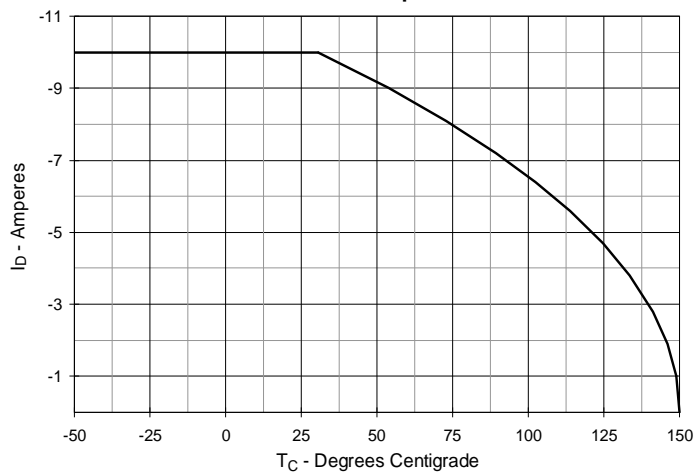

Fig. 7. Input Admittance

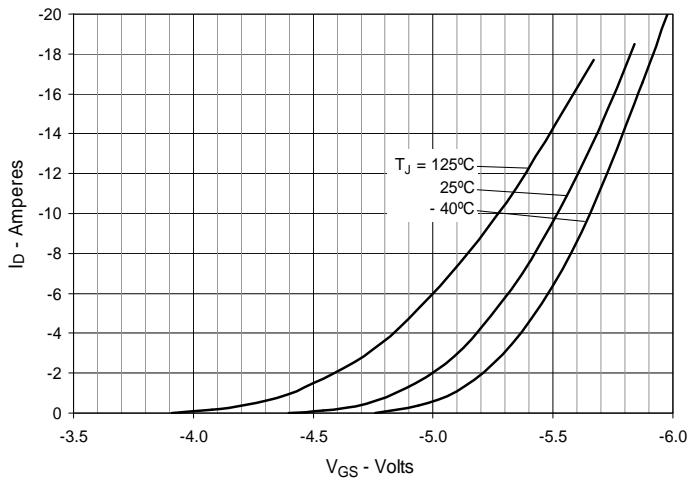

Fig. 8. Transconductance

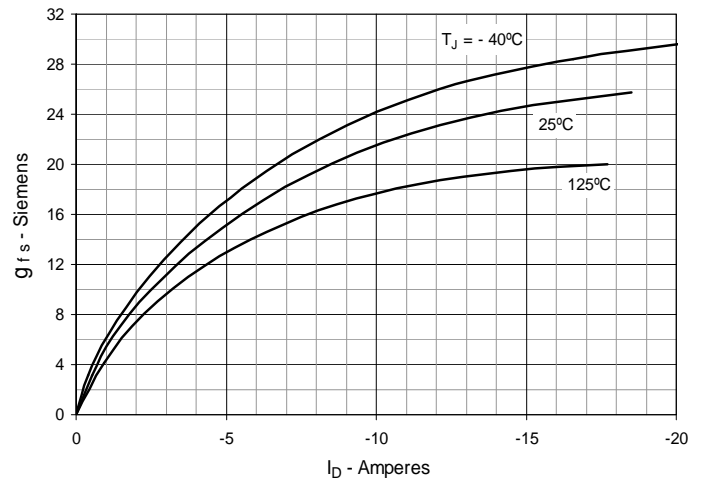

Fig. 9. Forward Voltage Drop of Intrinsic Diode

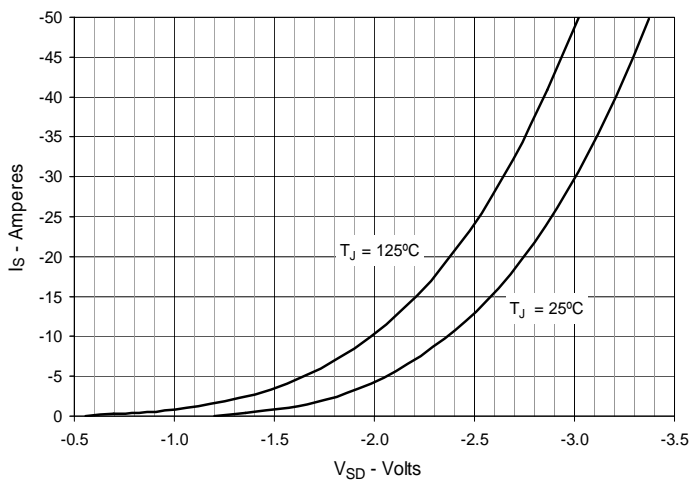

Fig. 10. Gate Charge

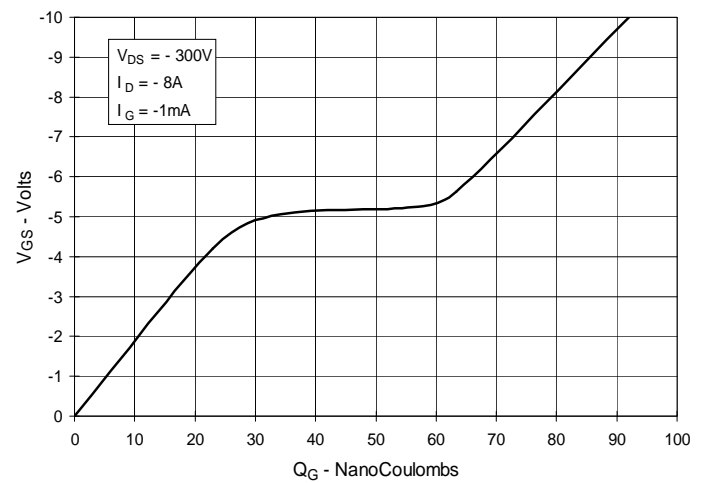

Fig. 11. Capacitance

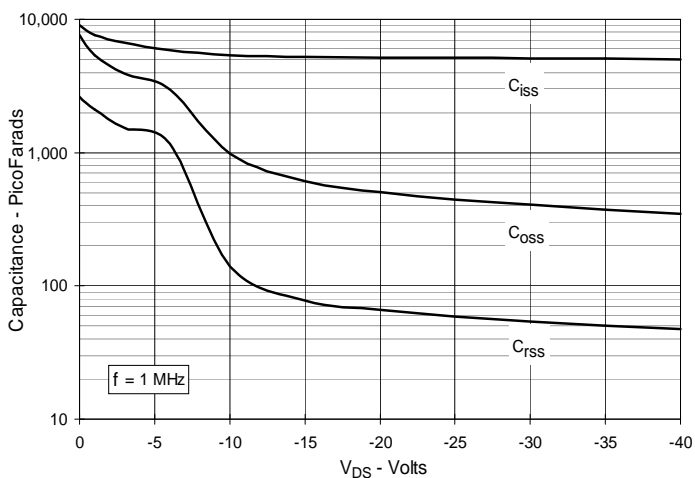

Fig. 12. Forward-Bias Safe Operating Area

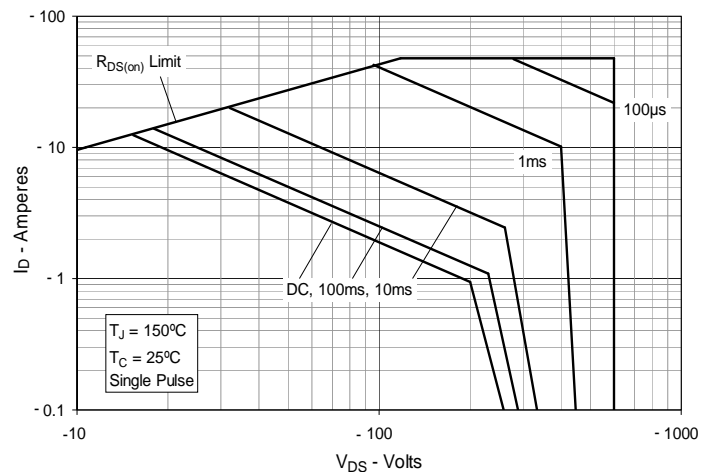
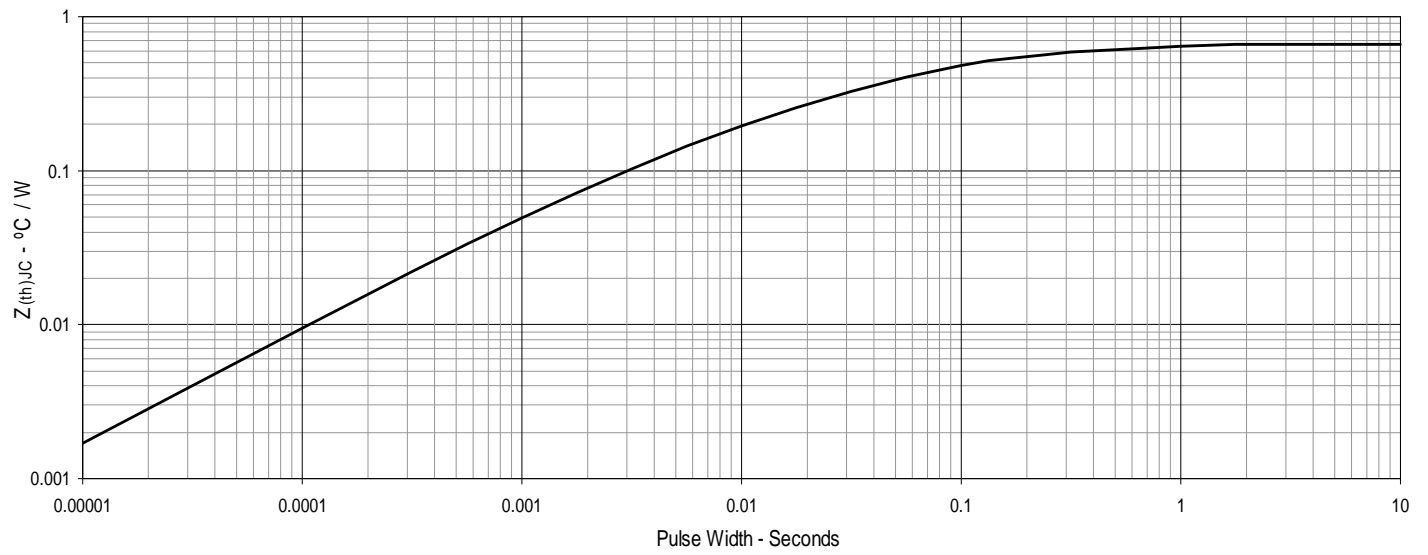

Fig. 13. Maximum Transient Thermal Impedance



Mouser Electronics

Authorized Distributor

Click to View Pricing, Inventory, Delivery & Lifecycle Information:

[IXYS:](#)

[IXTR16P60P](#)