

# CoolMOS™ 1) Power MOSFET

N-Channel Enhancement Mode  
 Low  $R_{DS(on)}$ , High  $V_{DSS}$  MOSFET  
 Ultra low gate charge

$$I_{D25} = 30 \text{ A}$$

$$V_{DSS} = 600 \text{ V}$$

$$R_{DS(on) \text{ max}} = 0.125 \Omega$$



TO-247 AD

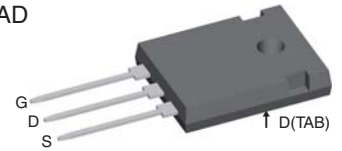

MOSFET			
Symbol	Conditions	Maximum Ratings	
$V_{DSS}$	$T_{VJ} = 25^\circ\text{C}$	600	V
$V_{GS}$		$\pm 20$	V
$I_{D25}$	$T_C = 25^\circ\text{C}$	30	A
$I_{D90}$	$T_C = 90^\circ\text{C}$	21	A
$E_{AS}$	single pulse } $I_D = 11 \text{ A}; T_C = 25^\circ\text{C}$ repetitive	708	mJ
$E_{AR}$		1.2	mJ
$dV/dt$	MOSFET $dV/dt$ ruggedness $V_{DS} = 0 \dots 480 \text{ V}$	50	V/ns

## Features

- fast CoolMOS™ 1) power MOSFET 4<sup>th</sup> generation
- High blocking capability
- Lowest resistance
- Avalanche rated for unclamped inductive switching (UIS)
- Low thermal resistance due to reduced chip thickness
- Enhanced total power density

## Applications

- Switched mode power supplies (SMPS)
- Uninterruptible power supplies (UPS)
- Power factor correction (PFC)
- Welding
- Inductive heating
- PDP and LCD adapter

Symbol	Conditions	Characteristic Values			
		$(T_{VJ} = 25^\circ\text{C}, \text{ unless otherwise specified})$			
		min.	typ.	max.	
$R_{DS(on)}$	$V_{GS} = 10 \text{ V}; I_D = 16 \text{ A}$		110	125	mΩ
$V_{GS(th)}$	$V_{DS} = V_{GS}; I_D = 1.1 \text{ mA}$	2.5	3	3.5	V
$I_{DSS}$	$V_{DS} = 600 \text{ V}; V_{GS} = 0 \text{ V}$			2	$\mu\text{A}$
			20		$\mu\text{A}$
$I_{GSS}$	$V_{GS} = \pm 20 \text{ V}; V_{DS} = 0 \text{ V}$			100	nA
$C_{iss}$	} $V_{GS} = 0 \text{ V}; V_{DS} = 100 \text{ V}$ $f = 1 \text{ MHz}$		2500		pF
$C_{oss}$				120	
$Q_g$	} $V_{GS} = 0 \text{ to } 10 \text{ V}; V_{DS} = 400 \text{ V}; I_D = 16 \text{ A}$		53	70	nC
$Q_{gs}$			12		nC
$Q_{gd}$			18		nC
$t_{d(on)}$	} $V_{GS} = 10 \text{ V}; V_{DS} = 400 \text{ V}$ $I_D = 16 \text{ A}; R_G = 3.3 \Omega$		15		ns
$t_r$			5		ns
$t_{d(off)}$			50		ns
$t_f$			5		ns
$R_{thJC}$				0.4	K/W

<sup>1)</sup> CoolMOS™ is a trademark of Infineon Technologies AG.

**Source-Drain Diode**

Symbol	Conditions	Characteristic Values			
		min.	typ.	max.	
( $T_{VJ} = 25^{\circ}\text{C}$ , unless otherwise specified)					
$I_S$	$V_{GS} = 0\text{ V}$			16	A
$V_{SD}$	$I_F = 16\text{ A}; V_{GS} = 0\text{ V}$		0.9	1.2	V
$t_{rr}$	} $I_F = 16\text{ A}; -di_F/dt = 100\text{ A}/\mu\text{s}; V_R = 400\text{ V}$		430		ns
$Q_{RM}$			9		$\mu\text{C}$
$I_{RM}$			42		A

**Component**

Symbol	Conditions	Maximum Ratings		
$T_{VJ}$	operating		-55...+150	$^{\circ}\text{C}$
$T_{stg}$			-55...+150	$^{\circ}\text{C}$
$M_d$	mounting torque		0.8 ... 1.2	Nm

Symbol	Conditions	Characteristic Values			
		min.	typ.	max.	
$R_{thCH}$	with heatsink compound		0.25		K/W
<b>Weight</b>			6		g

## TO-247 AD Outline

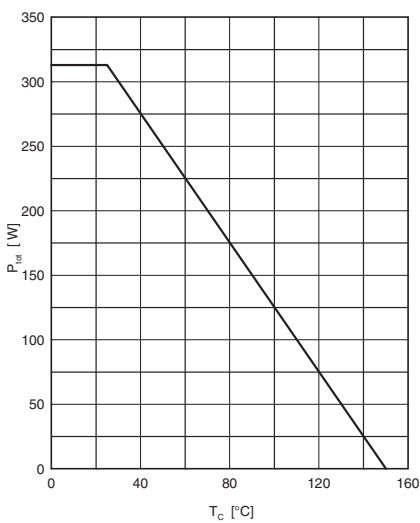
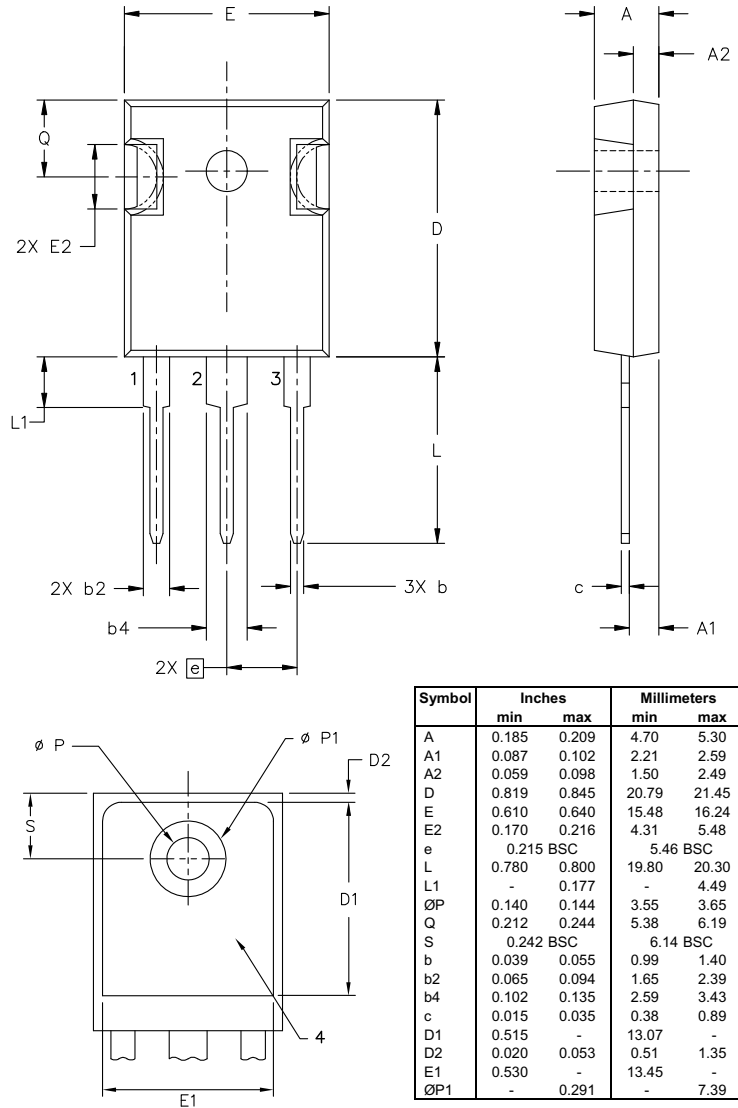

Fig. 1 Power dissipation

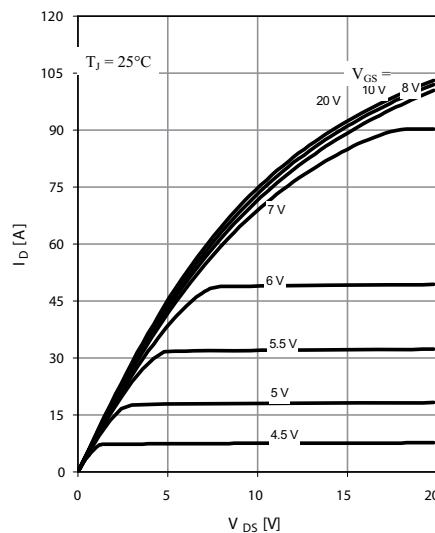

Fig. 2 Typ. output characteristics

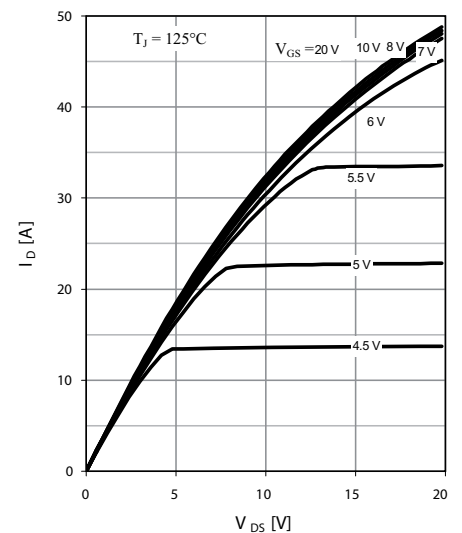

Fig. 3 Typ. output characteristics

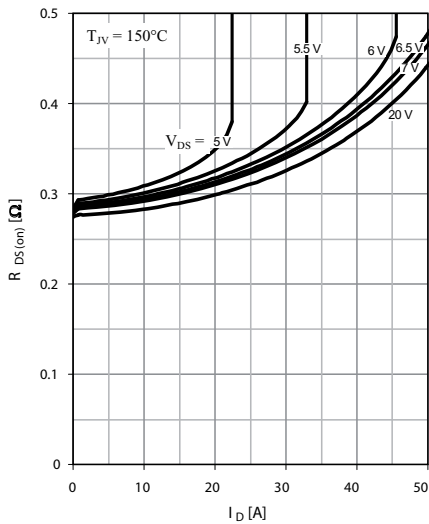

Fig. 4 Typ. drain-source on-state resistance characteristics of IGBT

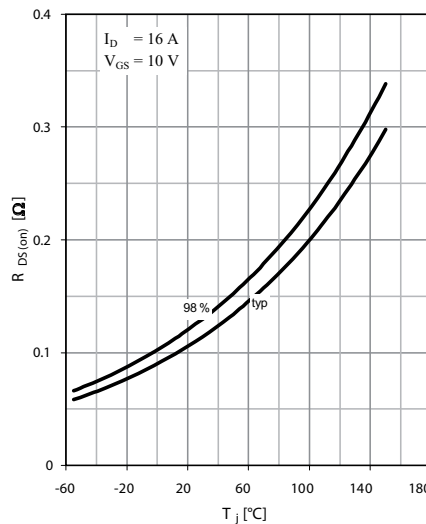

Fig. 5 Drain-source on-state resistance

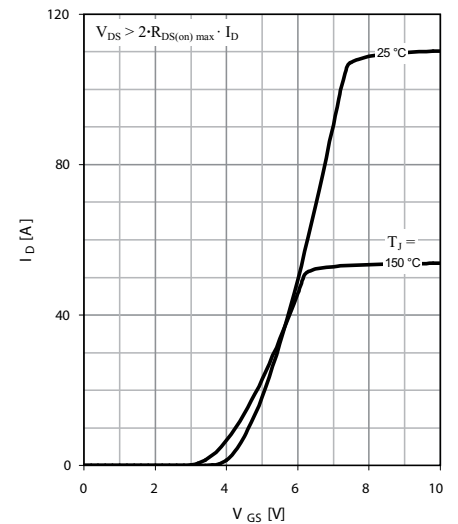

Fig. 6 Typ. transfer characteristics

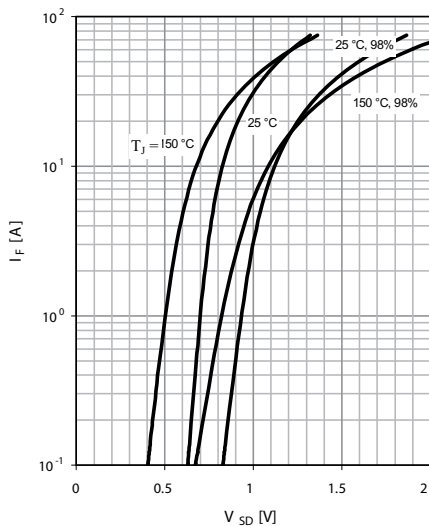

Fig. 7 Forward characteristic of reverse diode

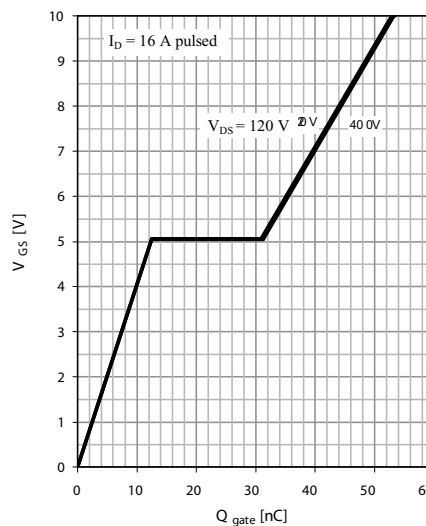

Fig. 8 Typ. gate charge

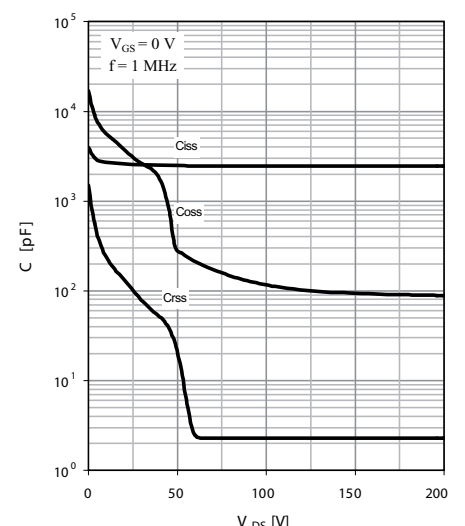

Fig. 9 Typ. capacitances

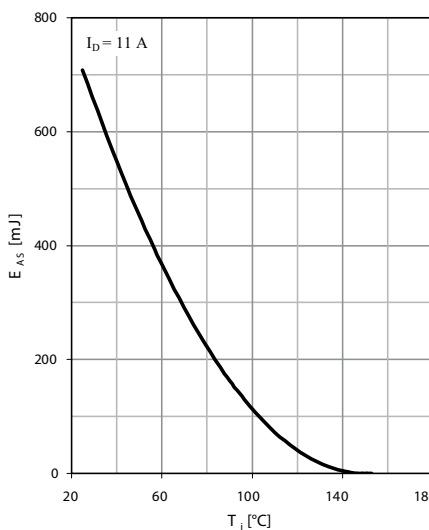

Fig. 10 Avalanche energy

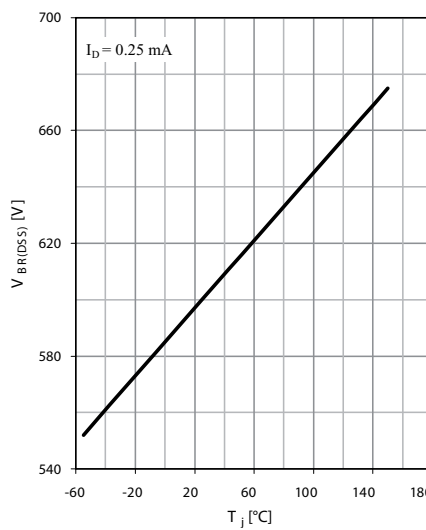

Fig. 11 Drain-source breakdown voltage

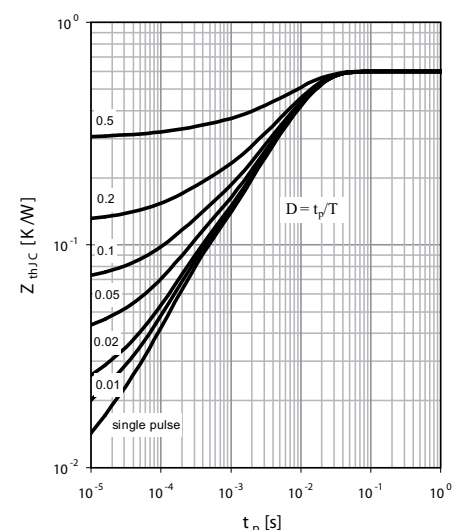

Fig. 12 Max. transient thermal impedance

IXYS reserves the right to change limits, test conditions and dimensions.

20090209d

# Mouser Electronics

Authorized Distributor

Click to View Pricing, Inventory, Delivery & Lifecycle Information:

[IXYS:](#)

[IXKH30N60C5](#)