

# Six-Pack XPT IGBT

 $V_{CES} = 1200\text{ V}$ 
 $I_{C25} = 60\text{ A}$ 
 $V_{CE(sat)} = 1.8\text{ V}$ 

**Part name** (Marking on product)

MIXA40W1200TED

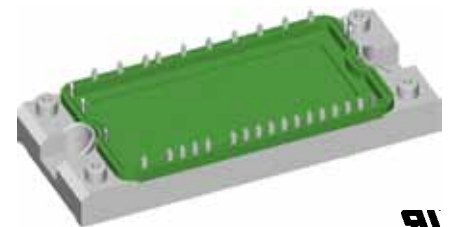
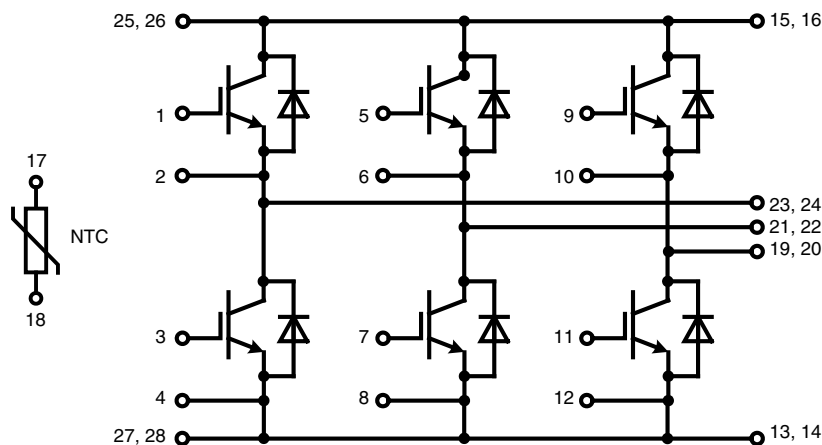

E 72873

Pin configuration see outlines.

### Features:

- Easy paralleling due to the positive temperature coefficient of the on-state voltage
- Rugged XPT design (Xtreme light Punch Through) results in:
  - short circuit rated for 10  $\mu\text{sec}$ .
  - very low gate charge
  - square RBSOA @ 3x  $I_C$
  - low EMI
- Thin wafer technology combined with the XPT design results in a competitive low  $V_{CE(sat)}$
- SONIC™ diode
  - fast and soft reverse recovery
  - low operating forward voltage

### Application:

- AC motor drives
- Solar inverter
- Medical equipment
- Uninterruptible power supply
- Air-conditioning systems
- Welding equipment
- Switched-mode and resonant-mode power supplies

### Package:

- "E2-Pack" standard outline
- Insulated copper base plate
- Soldering pins for PCB mounting
- Temperature sense included

**Output Inverter T1 - T6**

Symbol	Definitions	Conditions	Ratings			Unit	
			min.	typ.	max.		
$V_{CES}$	collector emitter voltage	$T_{VJ} = 25^{\circ}\text{C}$			1200	V	
$V_{GES}$	max. DC gate voltage	continuous			$\pm 20$	V	
$V_{GEM}$	max. transient collector gate voltage	transient			$\pm 30$	V	
$I_{C25}$	collector current	$T_C = 25^{\circ}\text{C}$			60	A	
$I_{C80}$		$T_C = 80^{\circ}\text{C}$			40	A	
$P_{tot}$	total power dissipation	$T_C = 25^{\circ}\text{C}$			195	W	
$V_{CE(sat)}$	collector emitter saturation voltage	$I_C = 35\text{ A}; V_{GE} = 15\text{ V}$			1.8 2.1	V V	
$V_{GE(th)}$	gate emitter threshold voltage	$I_C = 1.5\text{ mA}; V_{GE} = V_{CE}$	$T_{VJ} = 25^{\circ}\text{C}$	5.4	6.0	6.5	V
$I_{CES}$	collector emitter leakage current	$V_{CE} = V_{CES}; V_{GE} = 0\text{ V}$	$T_{VJ} = 25^{\circ}\text{C}$ $T_{VJ} = 125^{\circ}\text{C}$		0.2	2.1	mA mA
$I_{GES}$	gate emitter leakage current	$V_{GE} = \pm 20\text{ V}$				500	nA
$Q_{G(on)}$	total gate charge	$V_{CE} = 600\text{ V}; V_{GE} = 15\text{ V}; I_C = 35\text{ A}$			106		nC
$t_{d(on)}$	turn-on delay time	inductive load $V_{CE} = 600\text{ V}; I_C = 35\text{ A}$ $V_{GE} = \pm 15\text{ V}; R_G = 27\ \Omega$	$T_{VJ} = 125^{\circ}\text{C}$		70		ns
$t_r$	current rise time				40		ns
$t_{d(off)}$	turn-off delay time				250		ns
$t_f$	current fall time				100		ns
$E_{on}$	turn-on energy per pulse				3.8		mJ
$E_{off}$	turn-off energy per pulse				4.1		mJ
<b>RBSOA</b>	reverse bias safe operating area	$V_{GE} = \pm 15\text{ V}; R_G = 27\ \Omega;$	$T_{VJ} = 125^{\circ}\text{C}$ $V_{CEK} = 1200\text{ V}$			105	A
<b>SCSOA</b>	short circuit safe operating area		$T_{VJ} = 125^{\circ}\text{C}$				
$t_{SC}$	short circuit duration	$V_{CE} = 900\text{ V}; V_{GE} = \pm 15\text{ V};$ $R_G = 27\ \Omega;$ non-repetitive	$T_{VJ} = 125^{\circ}\text{C}$		140	10	$\mu\text{s}$ A
$I_{SC}$	short circuit current						
$R_{thJC}$	thermal resistance junction to case	(per IGBT)				0.64	K/W

**Output Inverter D1 - D6**

Symbol	Definitions	Conditions	Ratings			Unit	
			min.	typ.	max.		
$V_{RRM}$	max. repetitive reverse voltage	$T_{VJ} = 25^{\circ}\text{C}$			1200	V	
$I_{F25}$	forward current	$T_C = 25^{\circ}\text{C}$			44	A	
$I_{F80}$		$T_C = 80^{\circ}\text{C}$			29	A	
$V_F$	forward voltage	$I_F = 30\text{ A}; V_{GE} = 0\text{ V}$	$T_{VJ} = 25^{\circ}\text{C}$ $T_{VJ} = 125^{\circ}\text{C}$		1.95 1.95	2.2	V V
$Q_{rr}$	reverse recovery charge	$V_R = 600\text{ V}$ $di_F/dt = -600\text{ A}/\mu\text{s}$ $I_F = 30\text{ A}; V_{GE} = 0\text{ V}$	$T_{VJ} = 125^{\circ}\text{C}$		3.5		$\mu\text{C}$
$I_{RM}$	max. reverse recovery current				30		A
$t_{rr}$	reverse recovery time				350		ns
$E_{rec}$	reverse recovery energy				0.9		mJ
$R_{thJC}$	thermal resistance junction to case	(per diode)				1.2	K/W

 $T_C = 25^{\circ}\text{C}$  unless otherwise stated

**Temperature Sensor NTC**

Symbol	Definitions	Conditions	Ratings			Unit
			min.	typ.	max.	
$R_{25}$	resistance	$T_C = 25^\circ\text{C}$	4.75	5.0	5.25	k $\Omega$
$B_{25/50}$				3375		K

**Module**

Symbol	Definitions	Conditions	Ratings			Unit
			min.	typ.	max.	
$T_{VJ}$	operating temperature		-40		125	$^\circ\text{C}$
$T_{VJM}$	max. virtual junction temperature				150	$^\circ\text{C}$
$T_{stg}$	storage temperature		-40		125	$^\circ\text{C}$
$V_{ISOL}$	isolation voltage	$I_{ISOL} \leq 1 \text{ mA}; 50/60 \text{ Hz}$			2500	V~
CTI	comparative tracking index				-	
$M_d$	mounting torque (M5)		3		6	Nm
$d_S$	creep distance on surface		10			mm
$d_A$	strike distance through air		7.5			mm
$R_{pin-chip}$	resistance pin to chip			2.5		m $\Omega$
$R_{thCH}$	thermal resistance case to heatsink	with heatsink compound		0.02		K/W
<b>Weight</b>				180		g

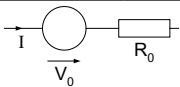
**Equivalent Circuits for Simulation**

Symbol	Definitions	Conditions	Ratings			Unit
			min.	typ.	max.	
$V_0$	IGBT	T1 - T6	$T_{VJ} = 150^\circ\text{C}$		1.1	V
$R_0$					40	m $\Omega$
$V_0$	free wheeling diode	D1 - D6	$T_{VJ} = 150^\circ\text{C}$		1.2	V
$R_0$					27	m $\Omega$

 $T_C = 25^\circ\text{C}$  unless otherwise stated

## Circuit Diagram

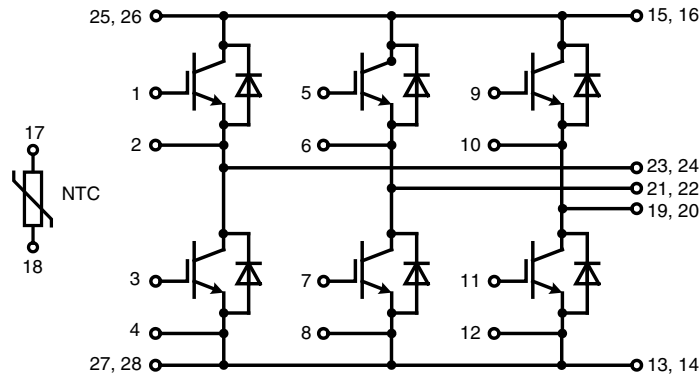

## Outline Drawing

Dimensions in mm (1 mm = 0.0394")



## Product Marking

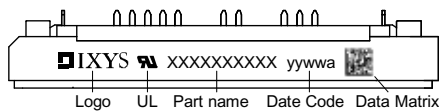

### Part number

- M = Module
- I = IGBT
- X = XPT
- A = Standard
- 40 = Current Rating [A]
- W = Six-Pack
- 1200 = Reverse Voltage [V]
- T = NTC
- ED = E2-Pack

Ordering	Part Name	Marking on Product	Delivering Mode	Base Qty	Ordering Code
Standard	MIXA40W1200 TED	MIXA40W1200TED	Box	6	507667

## Inverter T1 - T6

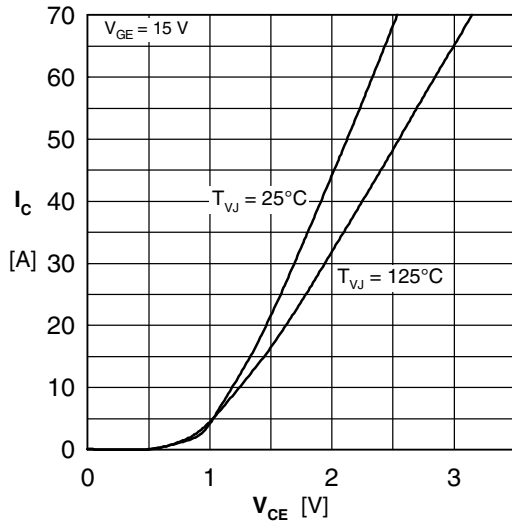

Fig. 1 Typ. output characteristics

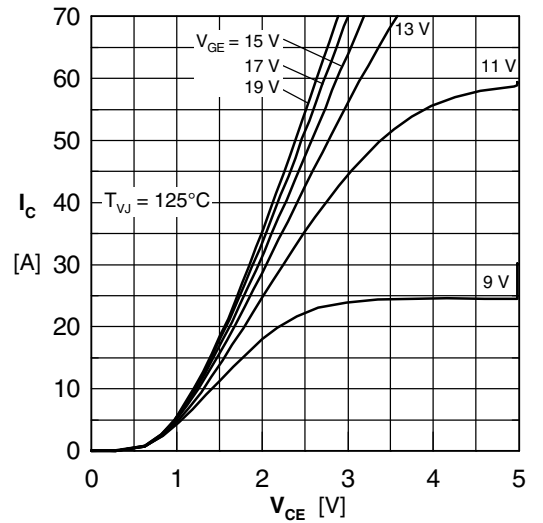

Fig. 2 Typ. output characteristics

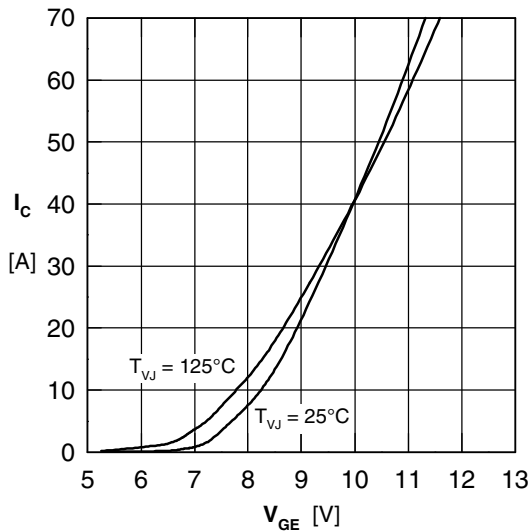

Fig. 3 Typ. transfer characteristics

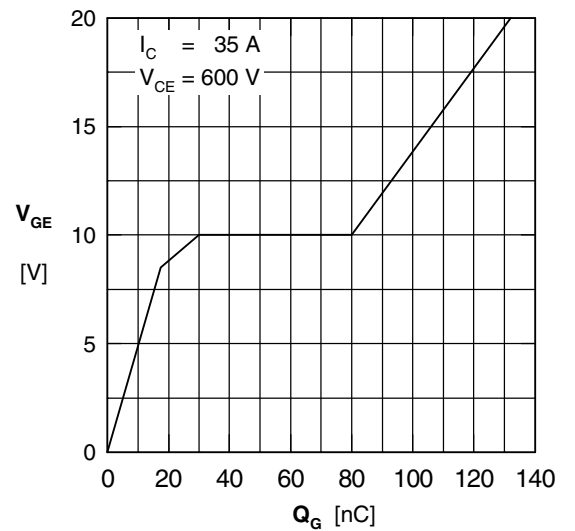

Fig. 4 Typ. turn-on gate charge

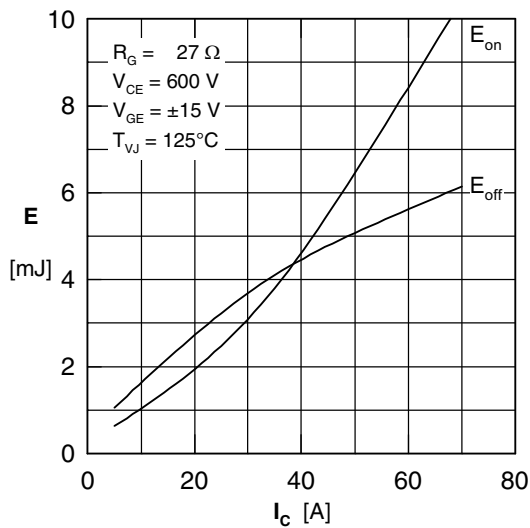

Fig. 5 Typ. switching energy vs. collector current

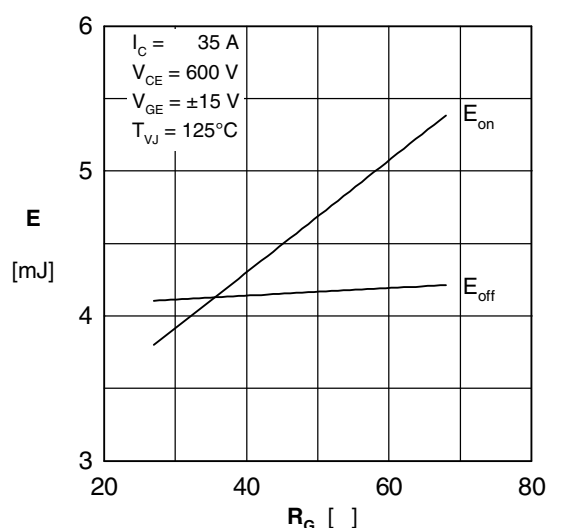

Fig. 6 Typ. switching energy vs. gate resistance

## Inverter D1 - D6

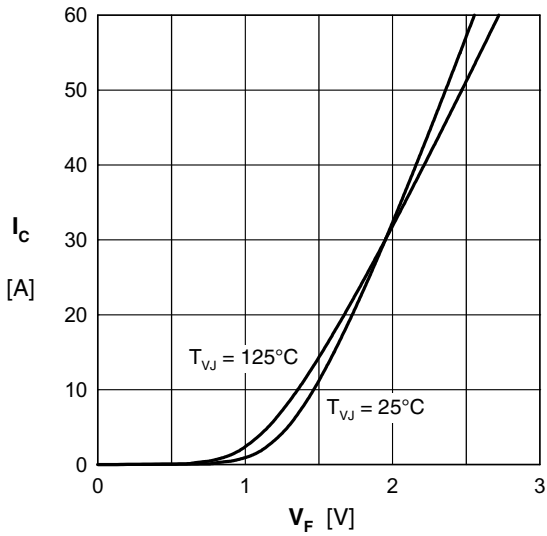

Fig. 7 Typ. forward characteristic

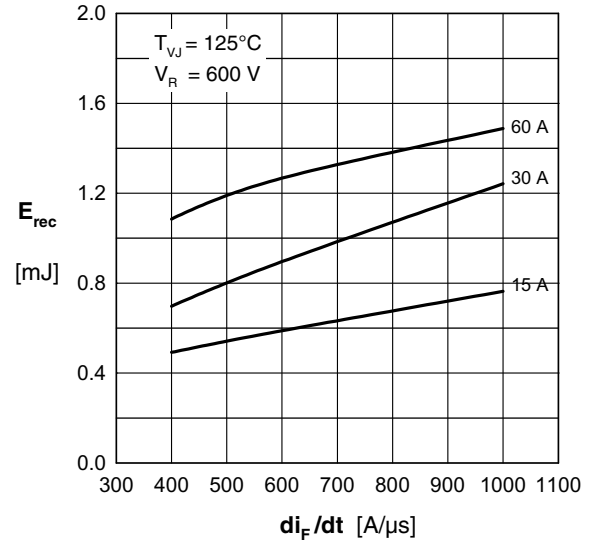

Fig. 8 Typ. recovery energy  $E_{rec}$  versus  $di/dt$

## NTC

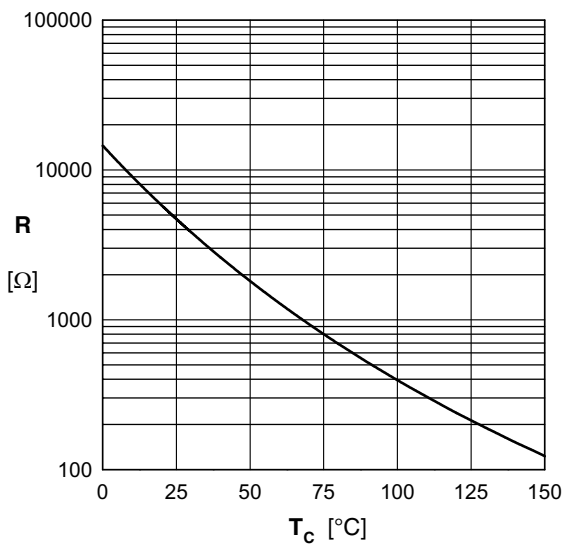

Fig. 9 Typ. NTC resistance versus temperature

	IGBT		FRD	
	$R_i$	$\tau_i$	$R_i$	$\tau_i$
1	0.152	0.0025	0.341	0.0025
2	0.072	0.03	0.217	0.03
3	0.308	0.03	0.348	0.03
4	0.108	0.08	0.294	0.08

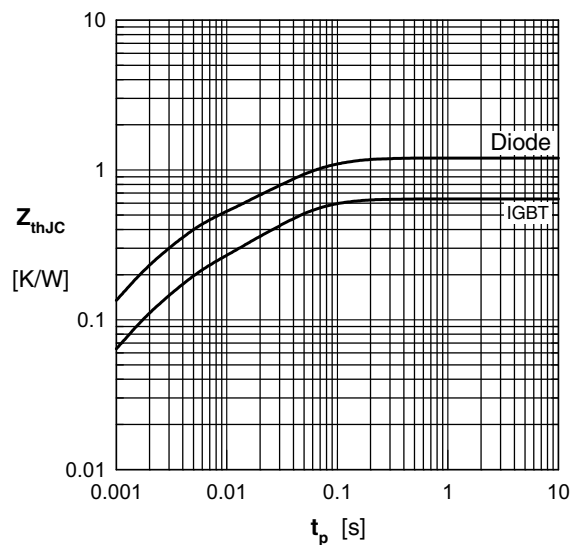

Fig. 10 Typ. transient thermal impedance

# Mouser Electronics

Authorized Distributor

Click to View Pricing, Inventory, Delivery & Lifecycle Information:

[IXYS:](#)

[MIXA40W1200TED](#)