

Three phase full Bridge with Trench MOSFETs in DCB-isolated high-current package

$V_{DSS} = 100\text{ V}$
 $I_{D25} = 120\text{ A}$
 $R_{DSon\ typ.} = 3.2\text{ m}\Omega$

Part number
MTI85W100GC

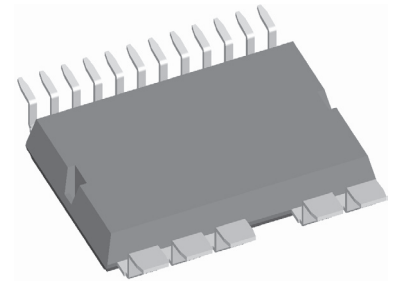

Surface Mount Device

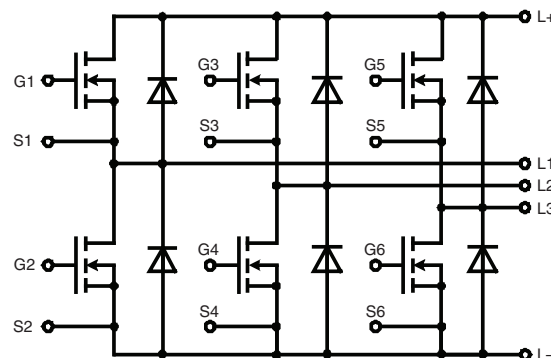

Features / Advantages:

- MOSFETs in trench technology:
 - low R_{DSon}
 - optimized intrinsic reverse diode
- Package:
 - high level of integration
 - high current capability (300 A max.)
 - aux. terminals for MOSFET control
 - terminals for soldering or welding connections
 - isolated DCB ceramic base plate with optimized heat transfer
- Space and weight savings

Applications:

- AC drives
- in automobiles
 - electric power steering
 - starter generator
 - in industrial vehicles
 - propulsion drives
 - fork lift drives
 - in battery supplied equipment

Package: ISOPLUS-DIL®

- High level of integration
- RoHS compliant
- High current capability
- Aux. Terminals for MOSFET control
- Terminals for soldering or welding connections
- Space and weight savings

Terms & Conditions of usage

The data contained in this product data sheet is exclusively intended for technically trained staff. The user will have to evaluate the suitability of the product for the intended application and the completeness of the product data with respect to his application. The specifications of our components may not be considered as an assurance of component characteristics. The information in the valid application- and assembly notes must be considered. Should you require product information in excess of the data given in this product data sheet or which concerns the specific application of your product, please contact the sales office, which is responsible for you. Due to technical requirements our product may contain dangerous substances. For information on the types in question please contact the sales office, which is responsible for you.

Should you intend to use the product in aviation, in health or life endangering or life support applications, please notify. For any such application we urgently recommend

- to perform joint risk and quality assessments;

- the conclusion of quality agreements;

- to establish joint measures of an ongoing product survey, and that we may make delivery dependent on the realization of any such measures.

MOSFETs				Ratings		
Symbol	Definitions	Conditions	min.	typ.	max.	Unit
V_{DSS}	drain source breakdown voltage	$T_{VJ} = 25^{\circ}\text{C to } 150^{\circ}\text{C}$			100	V
V_{GS}	gate source voltage				± 15	V
V_{GSM}	max. transient gate source voltage				± 20	V
I_{D25}	continuous drain current	$T_C = 25^{\circ}\text{C}$			120	A
I_{D90}		$T_C = 90^{\circ}\text{C}$			90	A
I_{F25}	forward current	$T_C = 25^{\circ}\text{C}$				A
I_{F90}		$T_C = 90^{\circ}\text{C}$				A
$R_{DS(on)}^{1)}$	static drain source on resistance	on-chip level at $I_D = 80 \text{ A}; V_{GS} = 10 \text{ V}$	$T_{VJ} = 25^{\circ}\text{C}$ $T_{VJ} = 125^{\circ}\text{C}$	3.2 5.4	4	$\text{m}\Omega$ $\text{m}\Omega$
$V_{GS(th)}$	gate threshold voltage	$I_D = 150 \mu\text{A}; V_{DS} = V_{GS}$	$T_{VJ} = 25^{\circ}\text{C}$	2.0	3.5	V
I_{DSS}	drain source leakage current	$V_{DS} = V_{DSS}; V_{GS} = 0 \text{ V}$	$T_{VJ} = 25^{\circ}\text{C}$ $T_{VJ} = 125^{\circ}\text{C}$		1 100	μA μA
I_{GSS}	gate source leakage current	$V_{GS} = \pm 20 \text{ V}; V_{DS} = 0 \text{ V}$			500	nA
R_G	gate resistance	on-chip level				Ω
Q_g	total gate charge	} $V_{GS} = 10 \text{ V}; V_{DS} = 50 \text{ V}; I_D = 80 \text{ A}$		88		nC
Q_{gs}	gate source charge			30		nC
Q_{gd}	gate drain (Miller) charge			18		nC
$t_{d(on)}$	turn-on delay time	} inductive load $V_{GS} = 10 \text{ V}; V_{DS} = 50 \text{ V}$ $I_D = 80 \text{ A}; R_G = 39 \Omega$	$T_{VJ} = 125^{\circ}\text{C}$		90	ns
t_r	current rise time				55	ns
$t_{d(off)}$	turn-off delay time				480	ns
t_f	current fall time				40	ns
E_{on}	turn-on energy per pulse				130	μJ
E_{off}	turn-off energy per pulse				390	μJ
$E_{rec(off)}$	turn-off reverse recovery losses		10	μJ		
R_{thJC}	thermal resistance junction to case				1.2	K/W
R_{thJH}	thermal resistance junction to heatsink	with heat transfer paste (IXYS test setup)		1.5		K/W
		$^{1)} V_{DS} = I_D \cdot (R_{DS(on)} + 2 \cdot R_{Pin \text{ to Chip}})$				
Source-Drain Diode						
V_{SD}	source drain voltage	$I_F = 80 \text{ A}; V_{GS} = 0 \text{ V}$	$T_{VJ} = 25^{\circ}\text{C}$	0.9	1.2	V
Q_{RM}	reverse recovery charge	} $V_R = 50 \text{ V}; I_F = 80 \text{ A}; R_G = 39 \Omega$ $di/dt = 1500 \text{ A}/\mu\text{s}$	$T_{VJ} = 125^{\circ}\text{C}$		1.3	μC
I_{RM}	max. reverse recovery current				44	A
t_{rr}	reverse recovery time				45	ns

Package ISOPLUS-DIL®			Ratings			
Symbol	Definitions	Conditions	min.	typ.	max.	Unit
I_{RMS}	RMS current	per pin in main current paths (P+, N-, L1, L2, L3) may be additionally limited by external connections (PCB tracks)			300	A
T_{stg}	storage temperature		-55		125	°C
T_{VJM}	virtual junction temperature		-55		175	°C
V_{ISOL}	isolation voltage	$t = 1$ second	50/60 Hz, RMS, $I_{ISOL} \leq 1$ mA	1200		V
		$t = 1$ minute		1000		V
$R_{pin-chip}$	resistance terminal to chip	$V_{DS} = I_D \cdot (R_{DS(on)} + 2 \cdot R_{pin\ to\ chip})$		0.6		mΩ
C_P	coupling capacity	between shorted pins and back side metallization		160		pF
F_C	mounting force with clip		50		250	N
Weight				13		g

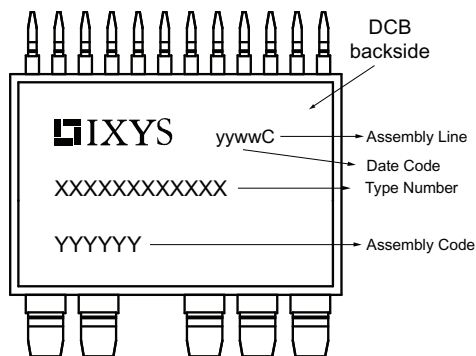
Part number

- M = Module
- T = Trench MOSFET
- I = Infineon Trench
- 145 = Current Rating [A]
- W = 6-Pack
- 100 = Reverse Voltage [V]
- GC = ISOPLUS-DIL

Ordering	Part Name	Marking on Product	Delivering Mode	Base Qty	Ordering Code
Standard	MTI85W100GC	MTI85W100GC	Blister	28	513341

Outlines ISOPLUS-DIL®

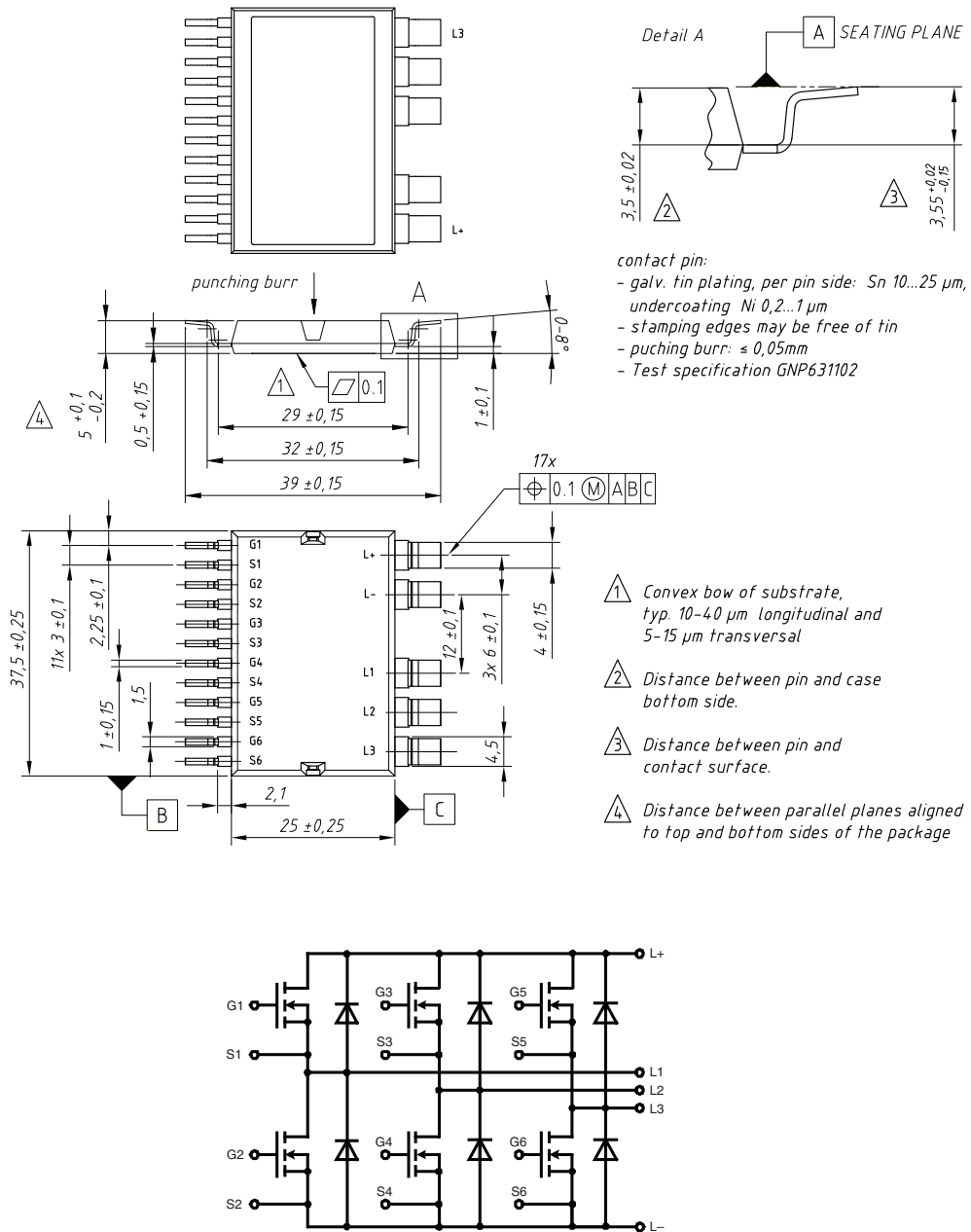

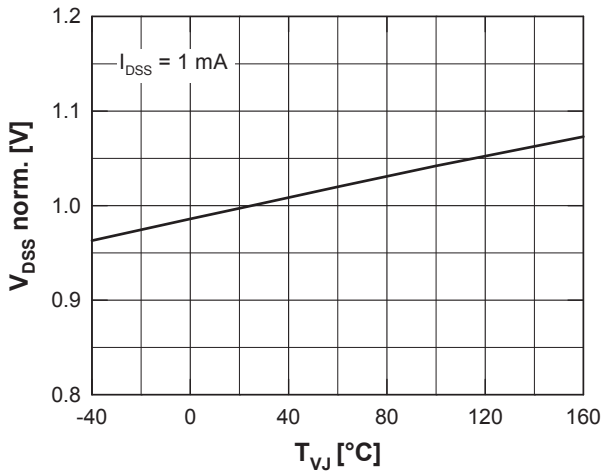

Fig. 1 Drain source breakdown voltage V_{DSS} vs. junction temperature T_{VJ}

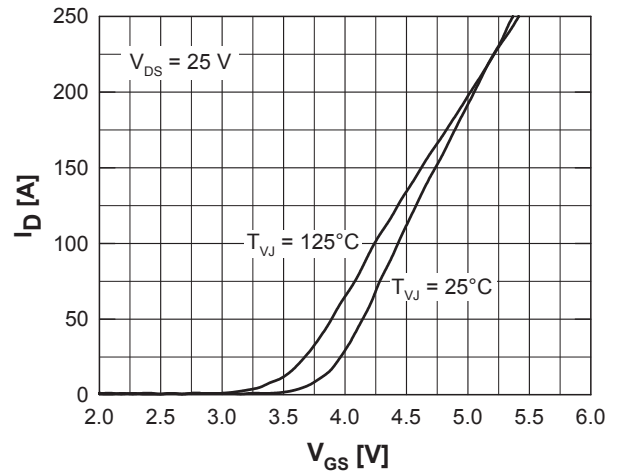

Fig. 2 Typ. transfer characteristics

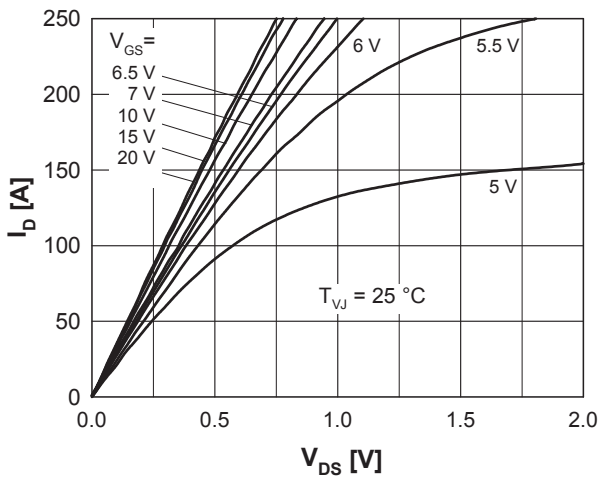

Fig. 3 Typ. output characteristics (25 °C)

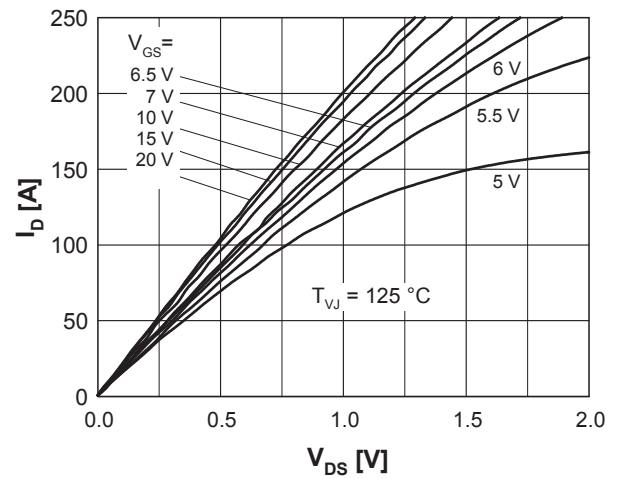

Fig. 4 Typ. output characteristics (125 °C)

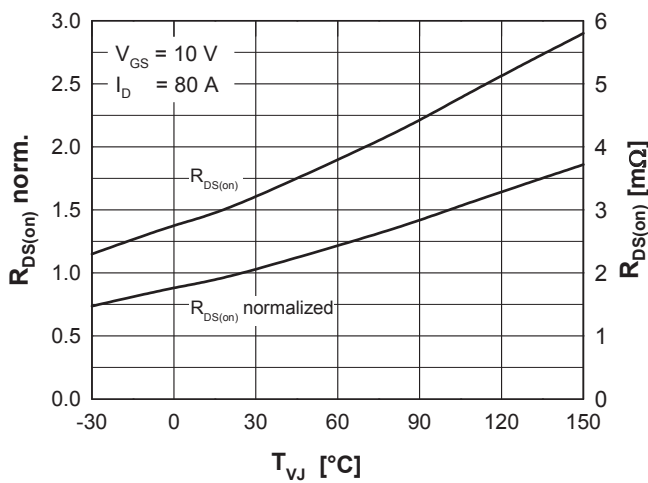

Fig. 5 Drain source on-state resistance versus junction temperature

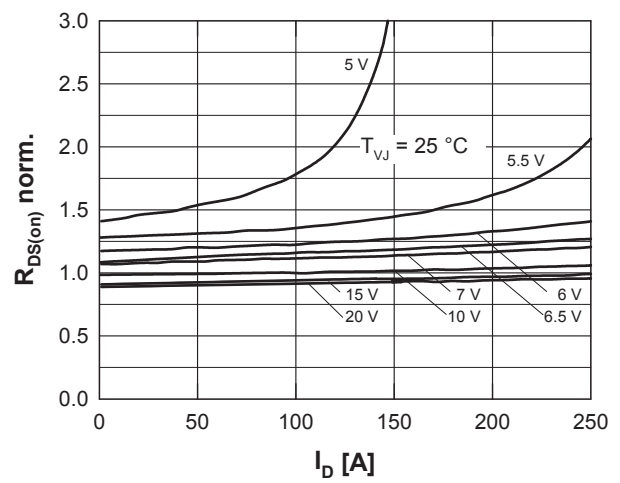

Fig. 6 Drain source on-state resistance versus I_D

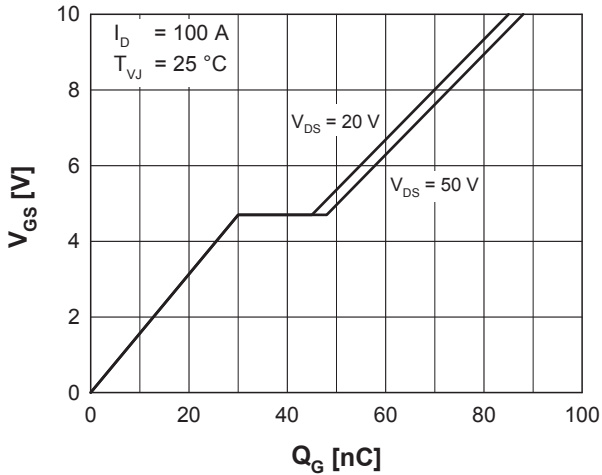

Fig. 7 Typical turn on gate charge

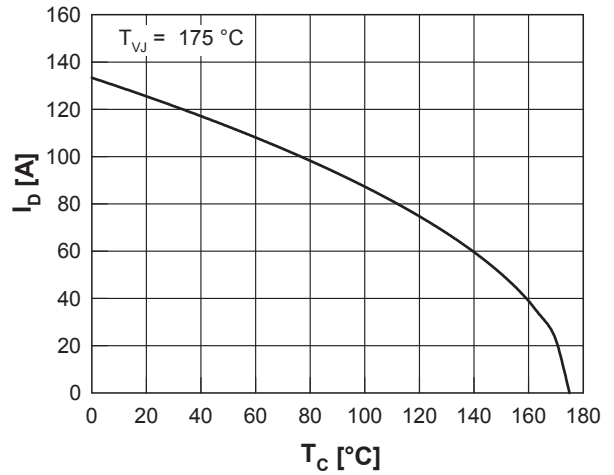

Fig. 8 Drain current I_D vs. case temperature T_C (chip capability)

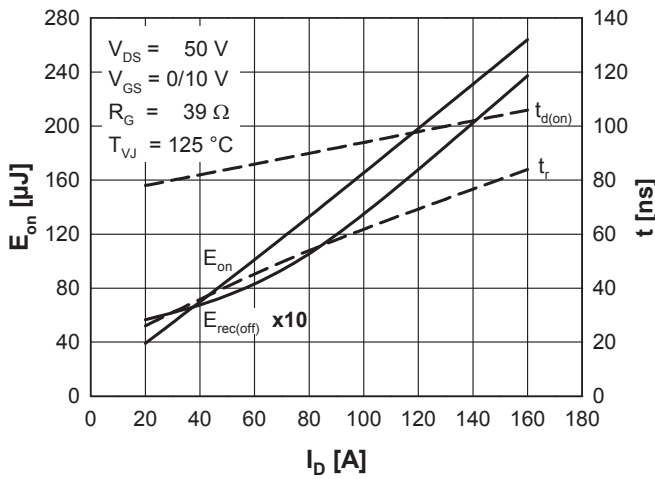

Fig. 9 Typ. turn-on energy and switching times versus drain current, inductive switching

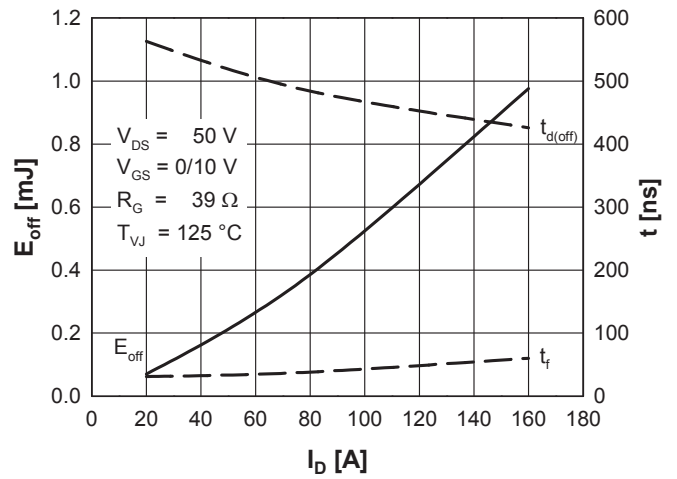

Fig. 10 Typ. turn-off energy and switching times versus drain-current, inductive switching

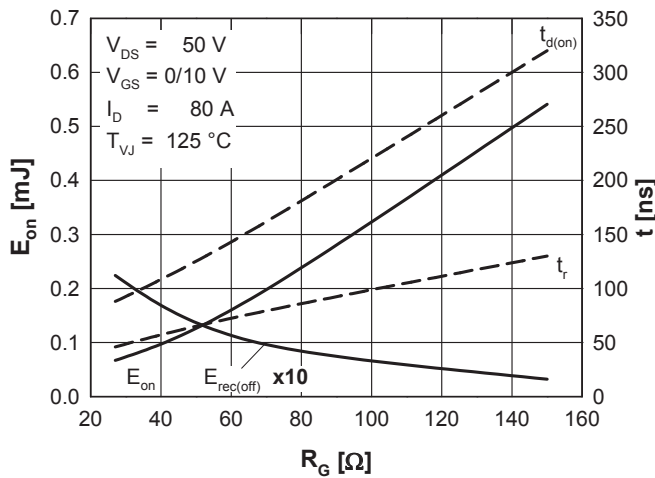

Fig. 11 Typ. turn-on energy and switching times versus gate resistor, inductive switching

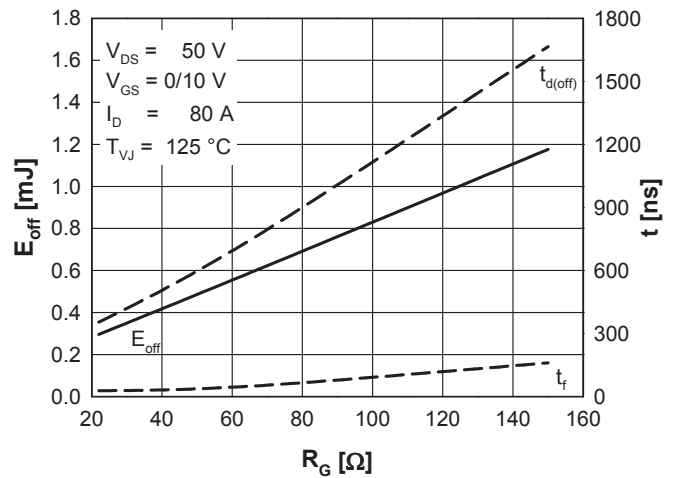

Fig. 12 Typ. turn-off energy and switching times versus gate resistor, inductive switching

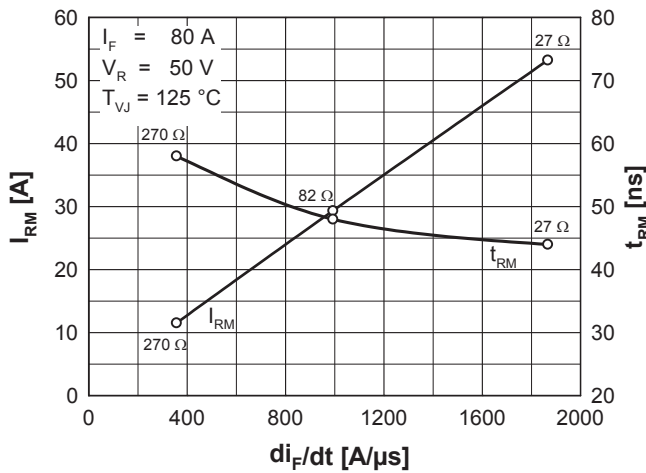

Fig. 13 Reverse recovery time t_{RM} of the body diode vs. di_F/dt

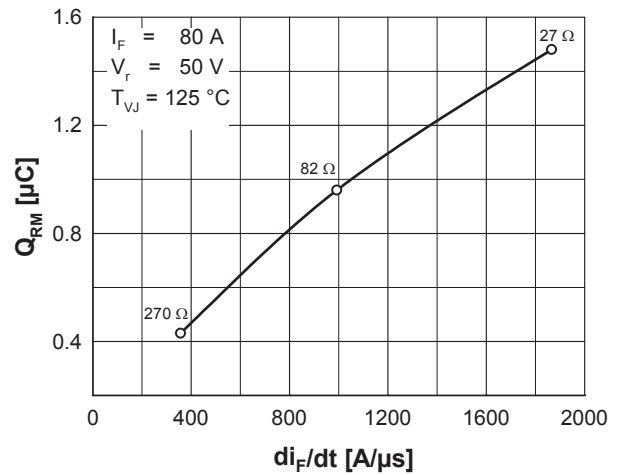

Fig. 14 Reverse recovery charge Q_{RM} of the body diode vs. di_F/dt

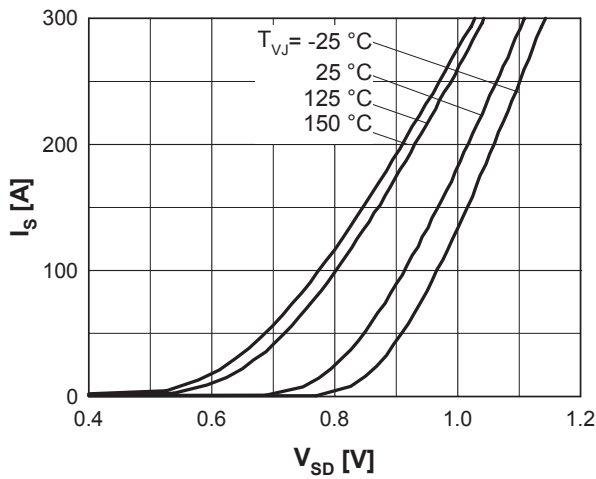

Fig.15 Source current I_S vs. source drain voltage V_{SD} (body diode)

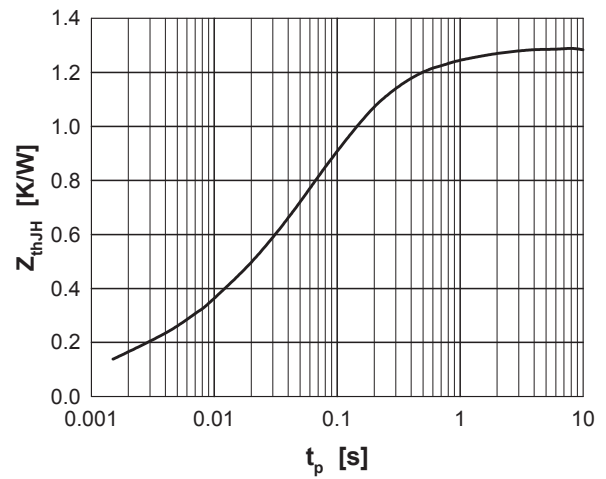

Fig. 16 Typ. thermal impedance junction to heatsink Z_{thJH} with heat transfer paste (IXYS test setup)

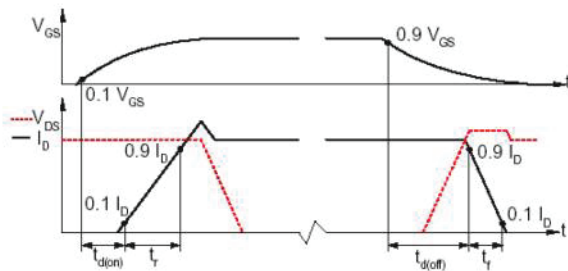

Fig. 17 Definition of switching times

Mouser Electronics

Authorized Distributor

Click to View Pricing, Inventory, Delivery & Lifecycle Information:

[IXYS:](#)

[MTI85W100GC](#)