

Standard Rectifier Module

3~ Rectifier	Brake Chopper
$V_{RRM} = 1600\text{ V}$	$V_{CES} = 1200\text{ V}$
$I_{DAV} = 120\text{ A}$	$I_{C25} = 120\text{ A}$
$I_{FSM} = 700\text{ A}$	$V_{CE(sat)} = 1.8\text{ V}$

3~ Rectifier Bridge + Brake Unit + NTC

Part number

VUB116-16NOXT

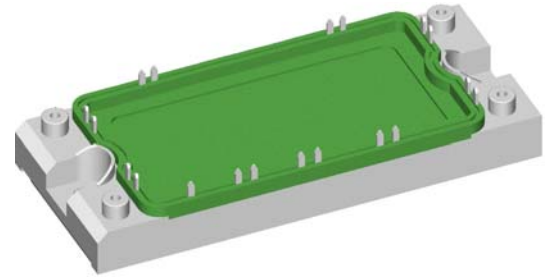

Backside: isolated

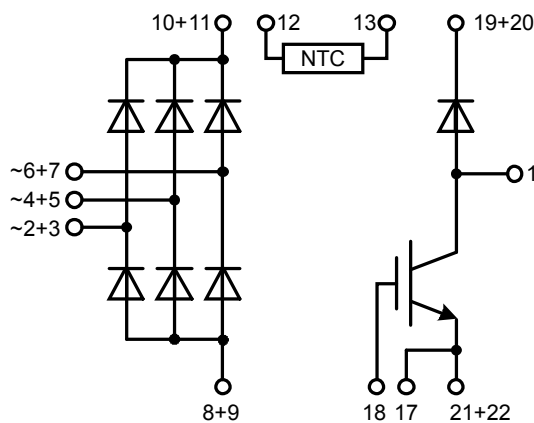
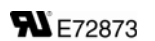

Features / Advantages:

- Package with DCB ceramic
- Improved temperature and power cycling
- Planar passivated chips
- Very low forward voltage drop
- Very low leakage current
- NTC

Applications:

- 3~ Rectifier with brake unit for drive inverters

Package: E2-Pack

- Isolation Voltage: 3600V~
- Industry standard outline
- RoHS compliant
- Soldering pins for PCB mounting
- Height: 17 mm
- Base plate: Copper internally DCB isolated
- Advanced power cycling

Rectifier				Ratings			
Symbol	Definition	Conditions		min.	typ.	max.	Unit
V_{RSM}	max. non-repetitive reverse blocking voltage					1700	V
V_{RRM}	max. repetitive reverse blocking voltage					1600	V
I_R	reverse current	$V_R = 1600$ V	$T_{VJ} = 25^\circ\text{C}$			100	μA
		$V_R = 1600$ V	$T_{VJ} = 150^\circ\text{C}$			1.5	mA
V_F	forward voltage drop	$I_F = 40$ A	$T_{VJ} = 25^\circ\text{C}$			1.19	V
						1.64	V
		$I_F = 120$ A	$T_{VJ} = 125^\circ\text{C}$			1.12	V
						1.70	V
I_{DAV}	bridge output current	$T_C = 105^\circ\text{C}$ rectangular	$T_{VJ} = 150^\circ\text{C}$			120	A
V_{FO}	threshold voltage					0.80	V
r_F	slope resistance					7.6	m Ω
R_{thJC}	thermal resistance junction to case					0.65	K/W
R_{thCH}	thermal resistance case to heatsink				0.1		K/W
P_{tot}	total power dissipation			$T_C = 25^\circ\text{C}$		190	W
I_{FSM}	max. forward surge current	$t = 10$ ms; (50 Hz), sine	$T_{VJ} = 45^\circ\text{C}$			700	A
						$t = 8,3$ ms; (60 Hz), sine	$V_R = 0$ V
		$t = 10$ ms; (50 Hz), sine	$T_{VJ} = 150^\circ\text{C}$			595	A
						$t = 8,3$ ms; (60 Hz), sine	$V_R = 0$ V
I^2t	value for fusing	$t = 10$ ms; (50 Hz), sine	$T_{VJ} = 45^\circ\text{C}$			2.45	kA ² s
						$t = 8,3$ ms; (60 Hz), sine	$V_R = 0$ V
		$t = 10$ ms; (50 Hz), sine	$T_{VJ} = 150^\circ\text{C}$			1.77	kA ² s
						$t = 8,3$ ms; (60 Hz), sine	$V_R = 0$ V
C_J	junction capacitance	$V_R = 400$ V; $f = 1$ MHz		$T_{VJ} = 25^\circ\text{C}$		27	pF

Brake IGBT				Ratings			
Symbol	Definition	Conditions	min.	typ.	max.	Unit	
V_{CES}	collector emitter voltage	$T_{VJ} = 25^{\circ}\text{C}$			1200	V	
V_{GES}	max. DC gate voltage				± 20	V	
V_{GEM}	max. transient gate emitter voltage				± 30	V	
I_{C25}	collector current	$T_C = 25^{\circ}\text{C}$			120	A	
I_{C80}		$T_C = 80^{\circ}\text{C}$			84	A	
P_{tot}	total power dissipation	$T_C = 25^{\circ}\text{C}$			390	W	
$V_{CE(sat)}$	collector emitter saturation voltage	$I_C = 75\text{ A}; V_{GE} = 15\text{ V}$			1.8	V	
					2.1	V	
						V	
$V_{GE(th)}$	gate emitter threshold voltage	$I_C = 3\text{ mA}; V_{GE} = V_{CE}$	5.5	6.0	6.5	V	
I_{CES}	collector emitter leakage current	$V_{CE} = V_{CES}; V_{GE} = 0\text{ V}$			0.2	mA	
					0.6	mA	
						mA	
I_{GES}	gate emitter leakage current	$V_{GE} = \pm 20\text{ V}$			500	nA	
$Q_{G(on)}$	total gate charge	$V_{CE} = 600\text{ V}; V_{GE} = 15\text{ V}; I_C = 75\text{ A}$		230		nC	
$t_{d(on)}$	turn-on delay time	inductive load $V_{CE} = 600\text{ V}; I_C = 75\text{ A}$ $V_{GE} = \pm 15\text{ V}; R_G = 10\ \Omega$		70		ns	
t_r	current rise time			40		ns	
$t_{d(off)}$	turn-off delay time			250		ns	
t_f	current fall time			100		ns	
E_{on}	turn-on energy per pulse			6.8		mJ	
E_{off}	turn-off energy per pulse			8.3		mJ	
RBSOA	reverse bias safe operating area	$V_{GE} = \pm 15\text{ V}; R_G = 10\ \Omega$					
I_{CM}		$V_{CEK} = 1200\text{ V}$			225	A	
SCSOA	short circuit safe operating area						
t_{SC}	short circuit duration	$V_{CE} = 900\text{ V}; V_{GE} = \pm 15\text{ V}$			10	μs	
I_{SC}	short circuit current	$R_G = 10\ \Omega$; non-repetitive		300		A	
R_{thJC}	thermal resistance junction to case				0.32	K/W	
R_{thCH}	thermal resistance case to heatsink				0.15	K/W	
Brake Diode							
V_{RRM}	max. repetitive reverse voltage				1200	V	
I_{F25}	forward current				48	A	
I_{F80}					32	A	
V_F	forward voltage	$I_F = 30\text{ A}$			2.75	V	
					1.99	V	
I_R	reverse current	$V_R = V_{RRM}$			0.25	mA	
					1	mA	
Q_{rr}	reverse recovery charge	$V_R = 600\text{ V}$ $-di_F/dt = 400\text{ A}/\mu\text{s}$ $I_F = 30\text{ A}$		1.8		μC	
I_{RM}	max. reverse recovery current			23		A	
t_{rr}	reverse recovery time			150		ns	
R_{thJC}	thermal resistance junction to case				0.9	K/W	
R_{thCH}	thermal resistance case to heatsink				0.3	K/W	

Package E2-Pack		Ratings				
Symbol	Definition	Conditions	min.	typ.	max.	Unit
I_{RMS}	RMS current	per terminal			200	A
T_{stg}	storage temperature		-40		125	°C
T_{VJ}	virtual junction temperature		-40		150	°C
Weight				176		g
M_D	mounting torque		3		6	Nm
$d_{Spp/App}$	creepage distance on surface striking distance through air	terminal to terminal	6.0			mm
$d_{Spb/Apb}$		terminal to backside	12.0			mm
V_{ISOL}	isolation voltage	t = 1 second	3600			V
		t = 1 minute	3000			V

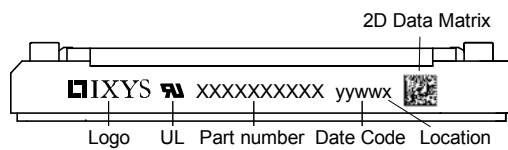

Ordering	Part Number	Marking on Product	Delivery Mode	Quantity	Code No.
Standard	VUB116-16NOXT	VUB116-16NOXT	Box	6	510755

Temperature Sensor NTC

Symbol	Definition	Conditions	min.	typ.	max.	Unit
R_{25}	resistance	$T_{VJ} = 25^\circ$	4.75	5	5.25	k Ω
$B_{25/50}$	temperature coefficient			3375		K

Equivalent Circuits for Simulation

* on die level

$T_{VJ} = 150^\circ\text{C}$

	Rectifier	Brake IGBT	Brake Diode	
V_0	0.8	1.1	1.31	V
R_0	4.5	17.9	8	m Ω

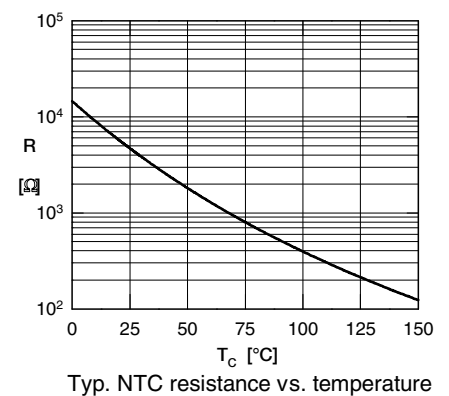

Outlines E2-Pack

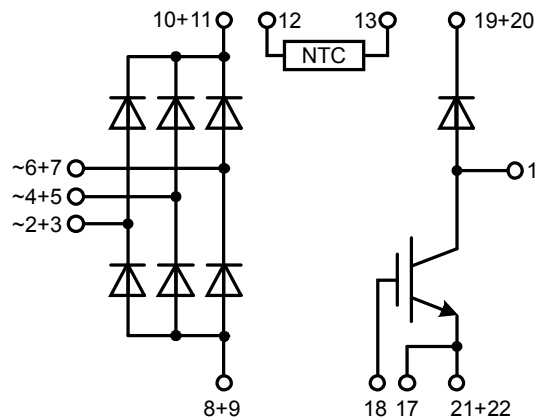
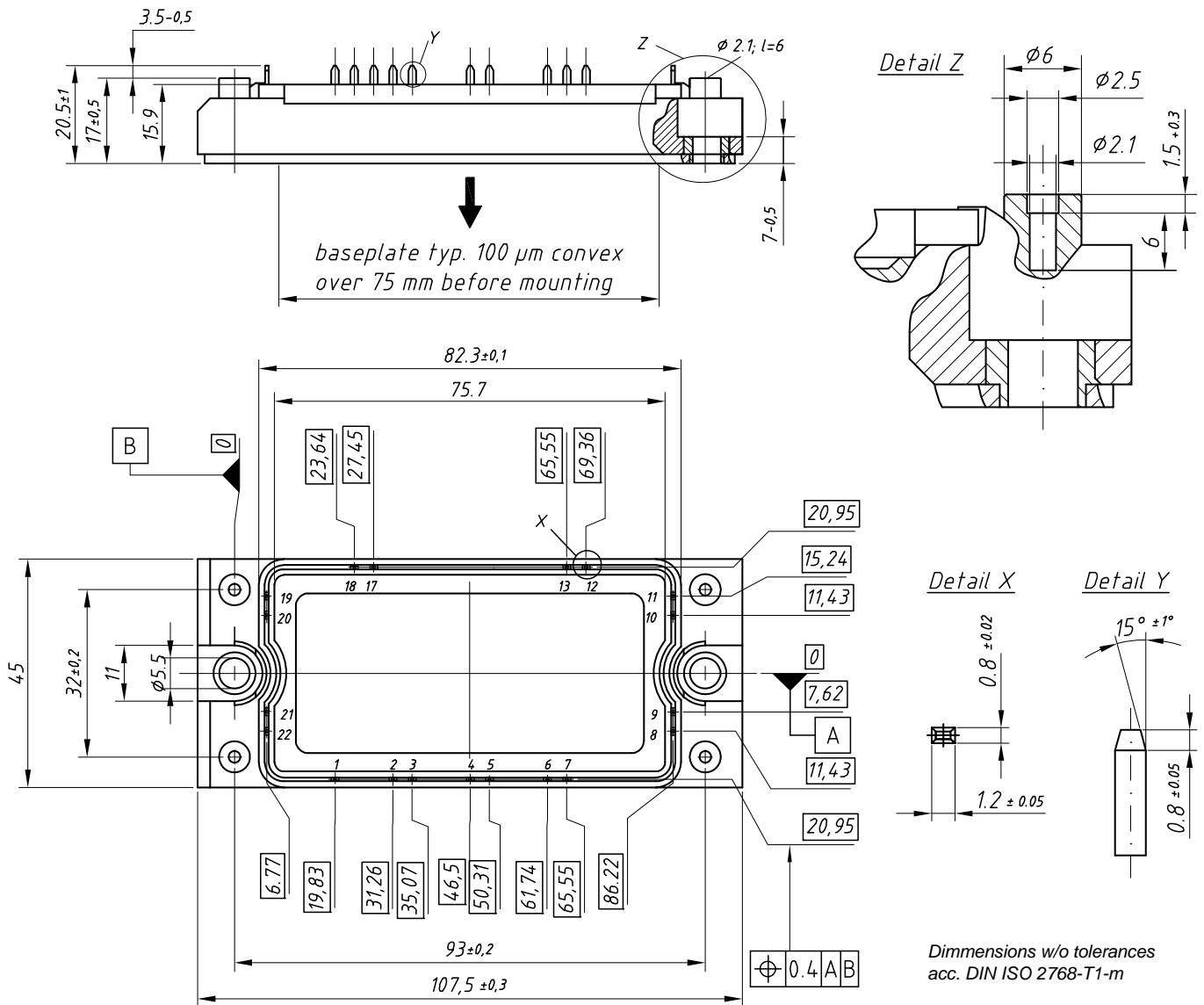

Rectifier

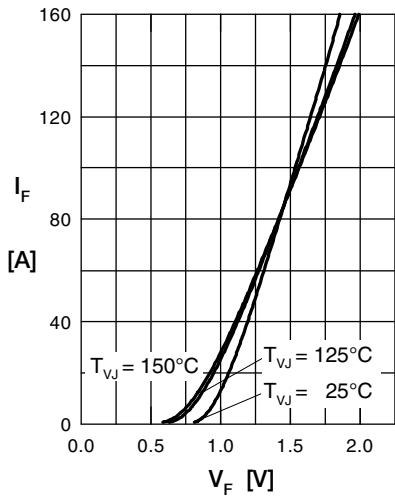

Fig. 1 Forward current versus voltage drop per diode

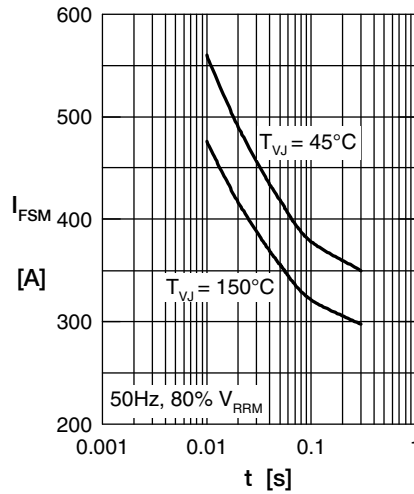

Fig. 2 Surge overload current

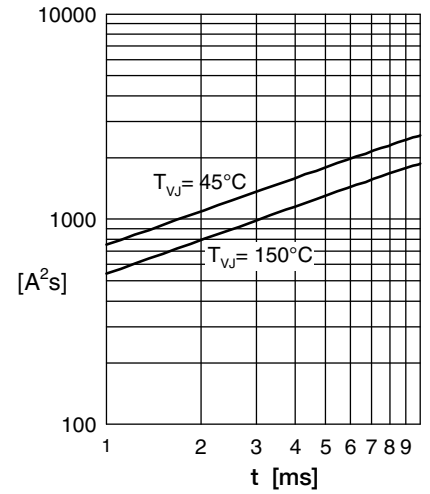

Fig. 3 I^2t versus time per diode

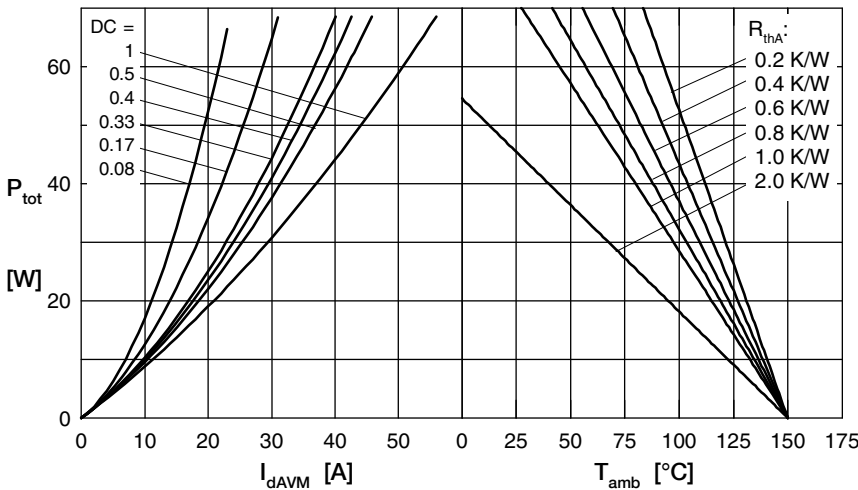

Fig. 4 Power dissipation vs. direct output current and ambient temperature

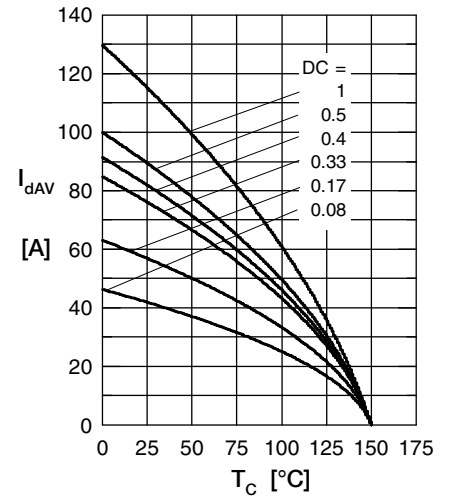

Fig. 5 Max. forward current vs. case temperature

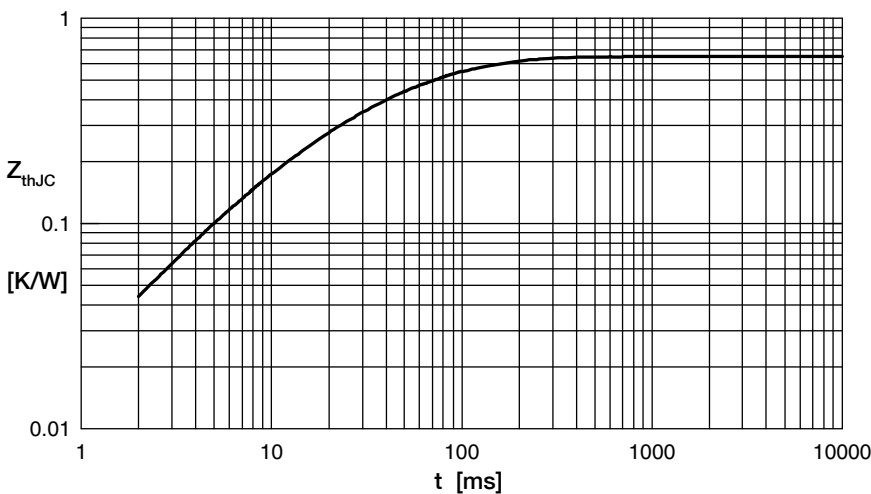

Fig. 6 Transient thermal impedance junction to case

R_i	i
0.085	0.012
0.041	0.007
0.309	0.036
0.215	0.102

Brake IGBT

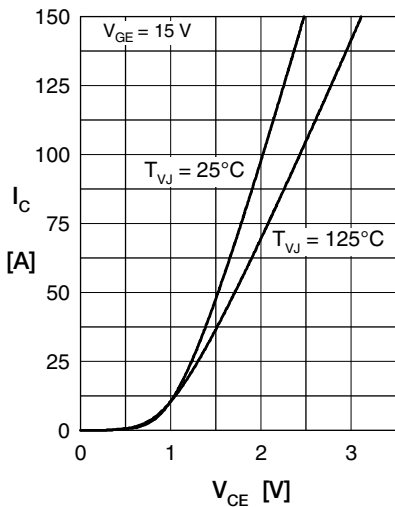

Fig. 1 Typ. output characteristics

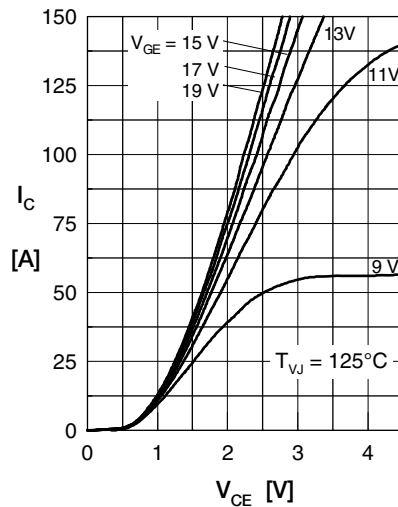

Fig. 2 Typ. output characteristics

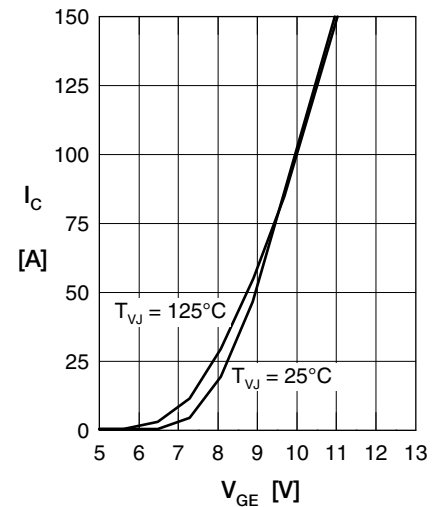

Fig. 3 Typ. transfer characteristics

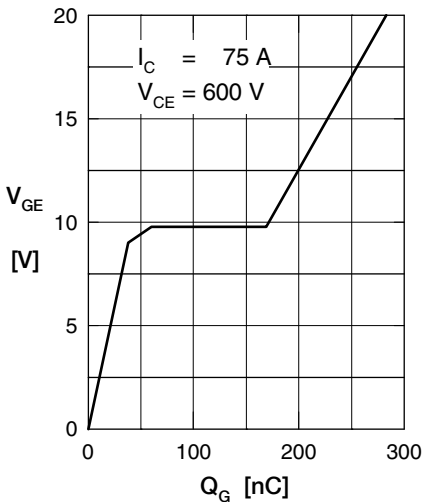

Fig. 4 Typ. turn-on gate charge

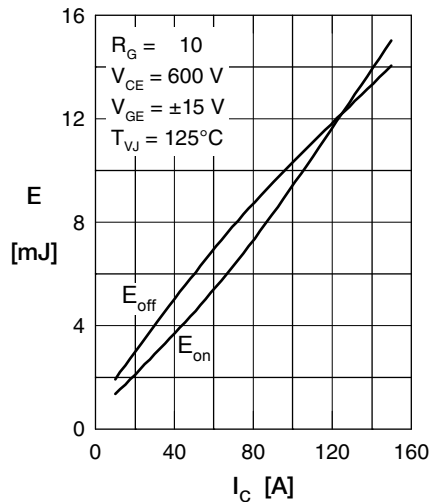

Fig. 5 Typ. switching energy versus collector current

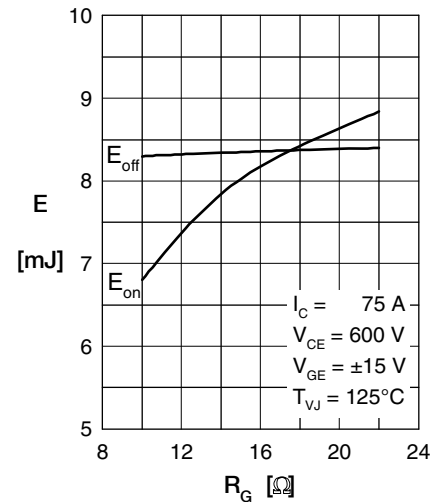

Fig. 6 Typ. switching energy versus gate resistance

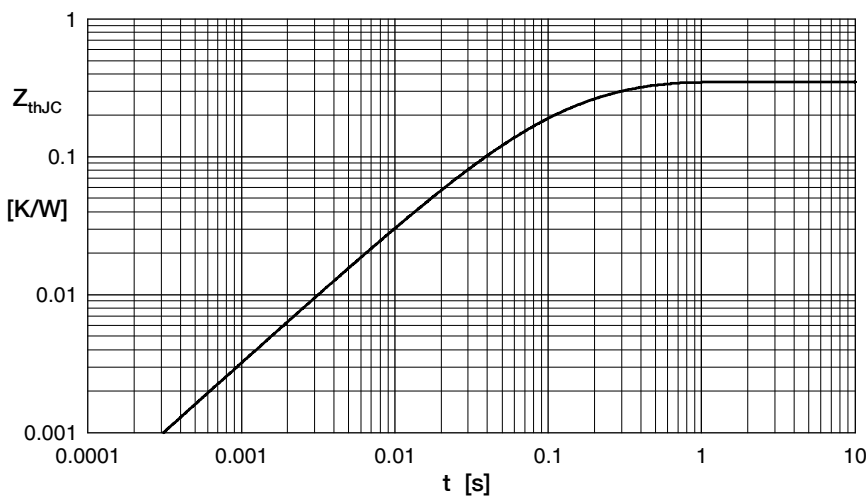

Fig. 7 Typ. transient thermal impedance junction to case

Brake Diode

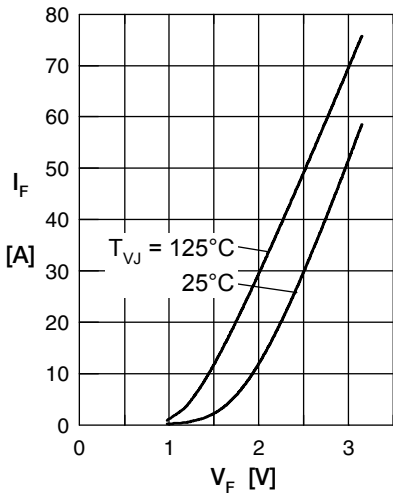

Fig. 1 Forward current I_F vs. V_F

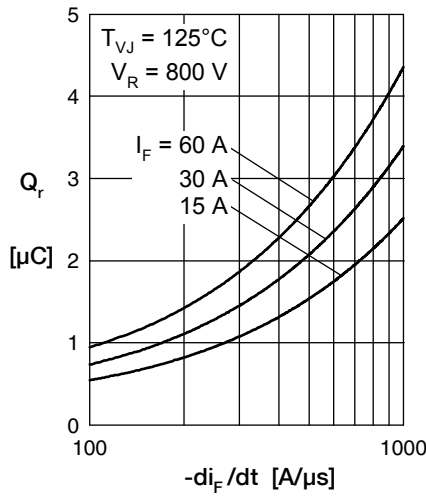

Fig. 2 Typ. reverse recovery charge Q_r versus $-di_F/dt$

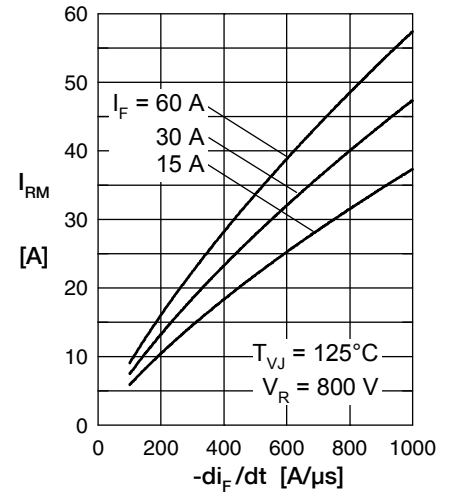

Fig. 3 Typ. peak reverse current I_{RM} versus $-di_F/dt$

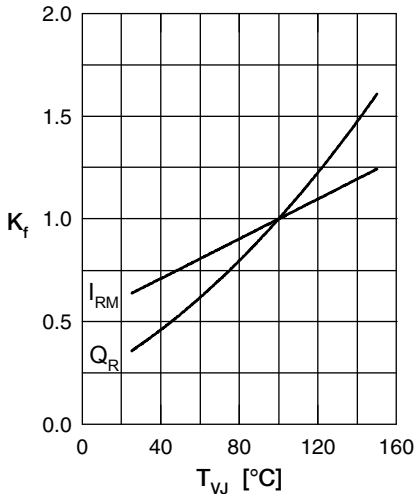

Fig. 4 Dynamic parameters Q_r , I_{RM} versus T_{VJ}

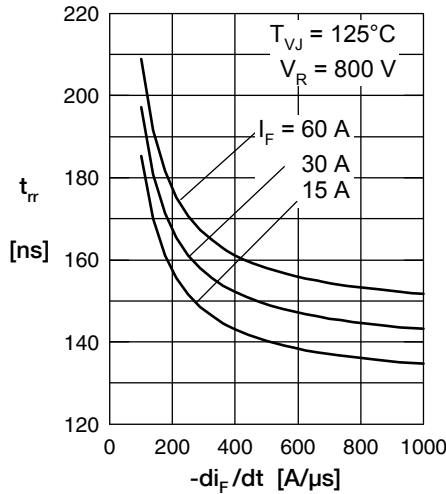

Fig. 5 Typ. recovery time t_{tr} versus $-di_F/dt$

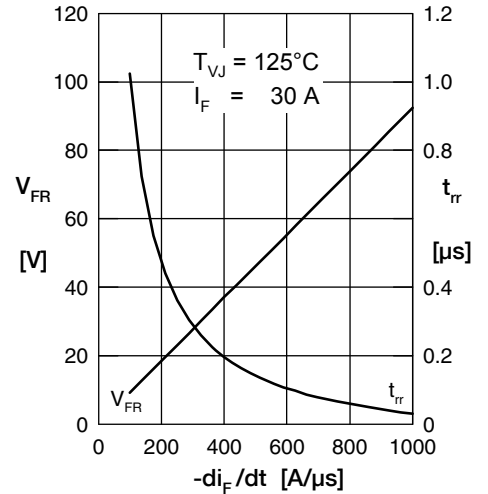

Fig. 6 Typ. peak forward voltage V_{FR} and t_{tr} versus di_F/dt

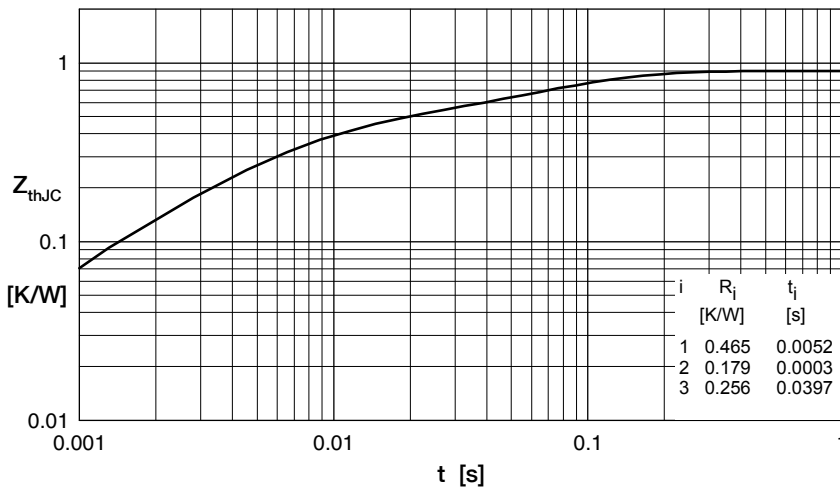

Fig. 7 Transient thermal impedance junction to case

Mouser Electronics

Authorized Distributor

Click to View Pricing, Inventory, Delivery & Lifecycle Information:

[IXYS:](#)

[VUB116-16NOXT](#)