

# GenX3™ B3-Class IGBTs

## IXGH72N60B3 IXGT72N60B3

Medium Speed low V<sub>sat</sub> PT IGBTs 5-40 kHz Switching

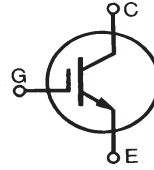

$V_{CES} = 600V$   
 $I_{C110} = 72A$   
 $V_{CE(sat)} \leq 1.80V$   
 $t_{fi(typ)} = 90ns$

Symbol	Test Conditions	Maximum Ratings	
$V_{CES}$	$T_J = 25^\circ C$ to $150^\circ C$	600	V
$V_{CGR}$	$T_J = 25^\circ C$ to $150^\circ C$ , $R_{GE} = 1M\Omega$	600	V
$V_{GES}$	Continuous	$\pm 20$	V
$V_{GEM}$	Transient	$\pm 30$	V
$I_{C25}$	$T_C = 25^\circ C$ (Limited by Leads)	75	A
$I_{C110}$	$T_C = 110^\circ C$	72	A
$I_{CM}$	$T_C = 25^\circ C$ , 1ms	400	A
$I_A$	$T_C = 25^\circ C$	20	A
$E_{AS}$	$T_C = 25^\circ C$	200	mJ
<b>SSOA</b> <b>(RBSOA)</b>	$V_{GE} = 15V$ , $T_{VJ} = 125^\circ C$ , $R_G = 3\Omega$ Clamped Inductive Load	$I_{CM} = 240$ @ $V_{CE} \leq 600$	A V
$P_C$	$T_C = 25^\circ C$	540	W
$T_J$		-55 ... +150	$^\circ C$
$T_{JM}$		150	$^\circ C$
$T_{stg}$		-55 ... +150	$^\circ C$
$M_d$	Mounting Torque (TO-247)	1.13 / 10	Nm/lb.in.
$T_L$	1.6mm (0.062 in.) from Case for 10s	300	$^\circ C$
$T_{SOLD}$	Plastic Body for 10 seconds	260	$^\circ C$
<b>Weight</b>	TO-247	6	g
	TO-268	5	g

TO-247 AD (IXGH)

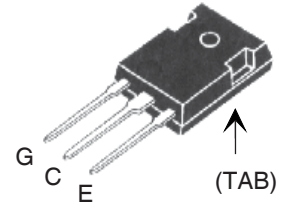

TO-268 (IXGT)

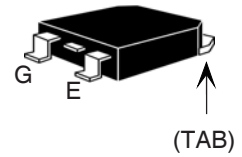

G = Gate      C = Collector  
 E = Emitter      TAB = Collector

### Features

- Optimized for Low Conduction and Switching Losses
- Square RBSOA
- Avalanche Rated
- International Standard Packages

### Advantages

- High Power Density
- Low Gate Drive Requirement

### Applications

- Power Inverters
- UPS
- Motor Drives
- SMPS
- PFC Circuits
- Battery Chargers
- Welding Machines
- Lamp Ballasts

Symbol	Test Conditions ( $T_J = 25^\circ C$ , Unless Otherwise Specified)	Characteristic Values		
		Min.	Typ.	Max.
$BV_{CES}$	$I_C = 250\mu A$ , $V_{GE} = 0V$	600		V
$V_{GE(th)}$	$I_C = 250\mu A$ , $V_{CE} = V_{GE}$	3.0		V
$I_{CES}$	$V_{CE} = V_{CES}$ , $V_{GE} = 0V$ $T_J = 125^\circ C$			75 $\mu A$ 750 $\mu A$
$I_{GES}$	$V_{CE} = 0V$ , $V_{GE} = \pm 20V$			$\pm 100$ nA
$V_{CE(sat)}$	$I_C = 60A$ , $V_{GE} = 15V$ , Note 1 $T_J = 125^\circ C$	1.51 1.48	1.80	V V

Symbol	Test Conditions ( $T_J = 25^\circ\text{C}$ , Unless Otherwise Specified)	Characteristic Values		
		Min.	Typ.	Max.
$g_{fs}$	$I_C = 60\text{A}, V_{CE} = 10\text{V}$ , Note 1	50	83	S
$C_{ies}$	$V_{CE} = 25\text{V}, V_{GE} = 0\text{V}, f = 1\text{MHz}$		6800	pF
$C_{oes}$			575	pF
$C_{res}$			80	pF
$Q_g$	$I_C = 60\text{A}, V_{GE} = 15\text{V}, V_{CE} = 0.5 \cdot V_{CES}$		230	nC
$Q_{ge}$			40	nC
$Q_{gc}$			82	nC
$t_{d(on)}$	<b>Inductive load, <math>T_J = 25^\circ\text{C}</math></b> $I_C = 50\text{A}, V_{GE} = 15\text{V}$ $V_{CE} = 480\text{V}, R_G = 3\Omega$		31	ns
$t_{ri}$			33	ns
$E_{on}$			1.38	mJ
$t_{d(off)}$			150	330 ns
$t_{fi}$			90	160 ns
$E_{off}$			1.05	2.0 mJ
$t_{d(on)}$	<b>Inductive load, <math>T_J = 125^\circ\text{C}</math></b> $I_C = 50\text{A}, V_{GE} = 15\text{V}$ $V_{CE} = 480\text{V}, R_G = 3\Omega$		29	ns
$t_{ri}$			34	ns
$E_{on}$			2.70	mJ
$t_{d(off)}$			228	ns
$t_{fi}$			142	ns
$E_{off}$			2.20	mJ
$R_{thJC}$	(TO-247)			0.23 $^\circ\text{C/W}$
$R_{thCS}$			0.25	$^\circ\text{C/W}$

### TO-247 AD Outline

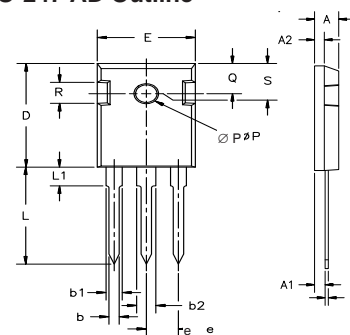

Dim.	Millimeter		Inches	
	Min.	Max.	Min.	Max.
A	4.7	5.3	.185	.209
A <sub>1</sub>	2.2	2.54	.087	.102
A <sub>2</sub>	2.2	2.6	.059	.098
b	1.0	1.4	.040	.055
b <sub>1</sub>	1.65	2.13	.065	.084
b <sub>2</sub>	2.87	3.12	.113	.123
C	.4	.8	.016	.031
D	20.80	21.46	.819	.845
E	15.75	16.26	.610	.640
e	5.20	5.72	0.205	0.225
L	19.81	20.32	.780	.800
L <sub>1</sub>		4.50		.177
∅P	3.55	3.65	.140	.144
Q	5.89	6.40	0.232	0.252
R	4.32	5.49	.170	.216
S	6.15	BSC	.242	BSC

### TO-268 Outline

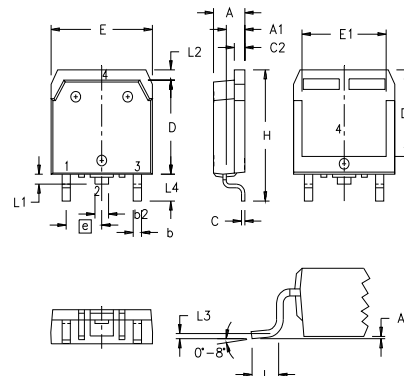

SYM	INCHES		MILLIMETERS	
	MIN	MAX	MIN	MAX
A	.193	.201	4.90	5.10
A1	.106	.114	2.70	2.90
A2	.001	.010	0.02	0.25
b	.045	.057	1.15	1.45
b2	.075	.083	1.90	2.10
C	.016	.026	0.40	0.65
C2	.057	.063	1.45	1.60
D	.543	.551	13.80	14.00
D1	.488	.500	12.40	12.70
E	.624	.632	15.85	16.05
E1	.524	.535	13.30	13.60
e	.215 BSC		5.45 BSC	
H	.736	.752	18.70	19.10
L	.094	.106	2.40	2.70
L1	.047	.055	1.20	1.40
L2	.039	.045	1.00	1.15
L3	.010 BSC		0.25 BSC	
L4	.150	.161	3.80	4.10

Note 1: Pulse Test,  $t \leq 300\mu\text{s}$ , Duty Cycle,  $d \leq 2\%$ .

IXYS Reserves the Right to Change Limits, Test Conditions, and Dimensions.

IXYS MOSFETs and IGBTs are covered by one or more of the following U.S. patents:

4,835,592	4,931,844	5,049,961	5,237,481	6,162,665	6,404,065 B1	6,683,344	6,727,585	7,005,734 B2	7,157,338B2
4,850,072	5,017,508	5,063,307	5,381,025	6,259,123 B1	6,534,343	6,710,405 B2	6,759,692	7,063,975 B2	
4,881,106	5,034,796	5,187,117	5,486,715	6,306,728 B1	6,583,505	6,710,463	6,771,478 B2	7,071,537	

**Fig. 1. Output Characteristics @ 25°C**

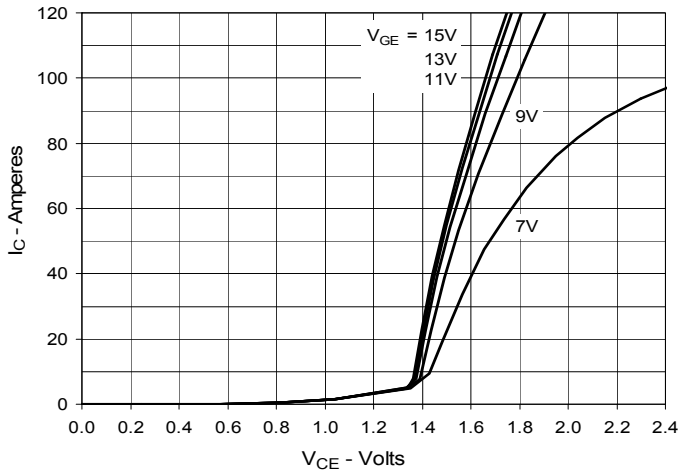

**Fig. 2. Extended Output Characteristics @ 25°C**

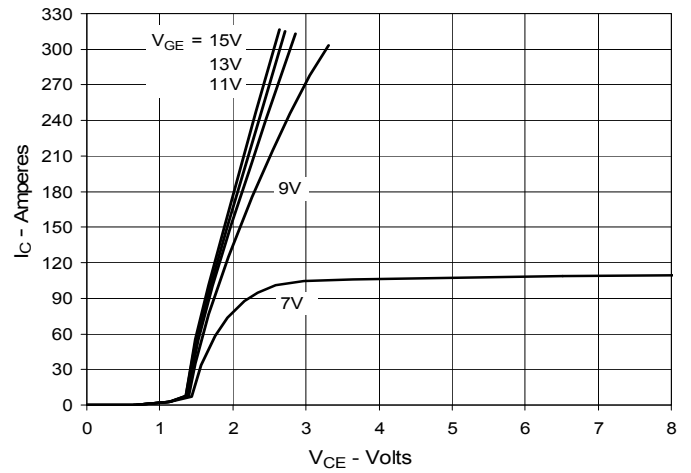

**Fig. 3. Output Characteristics @ 125°C**

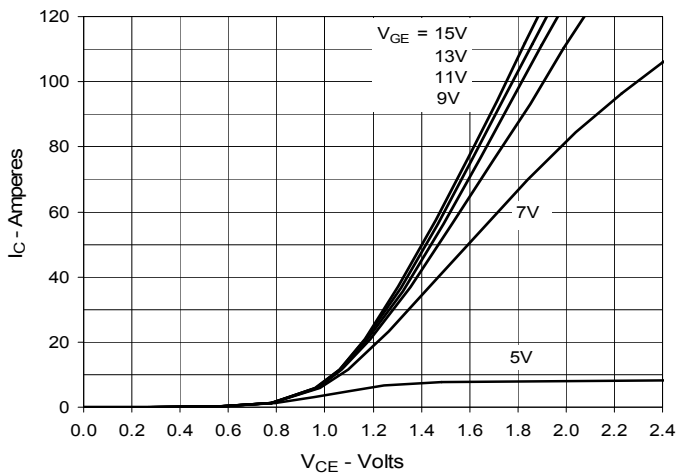

**Fig. 4. Dependence of Vce(sat) on Junction Temperature**

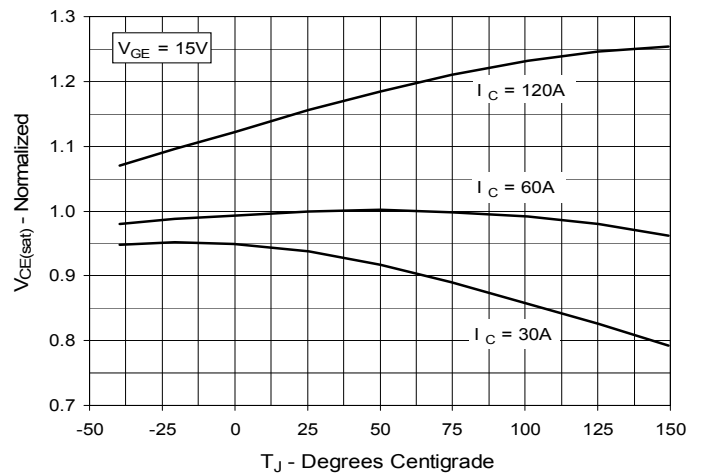

**Fig. 5. Collector-to-Emitter Voltage vs. Gate-to-Emitter Voltage**

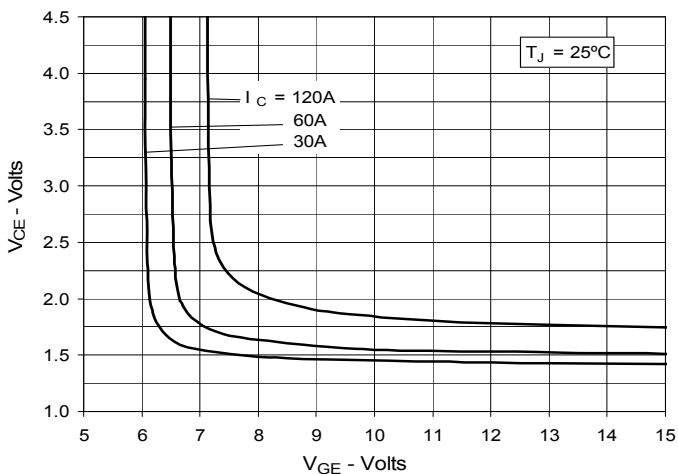

**Fig. 6. Input Admittance**

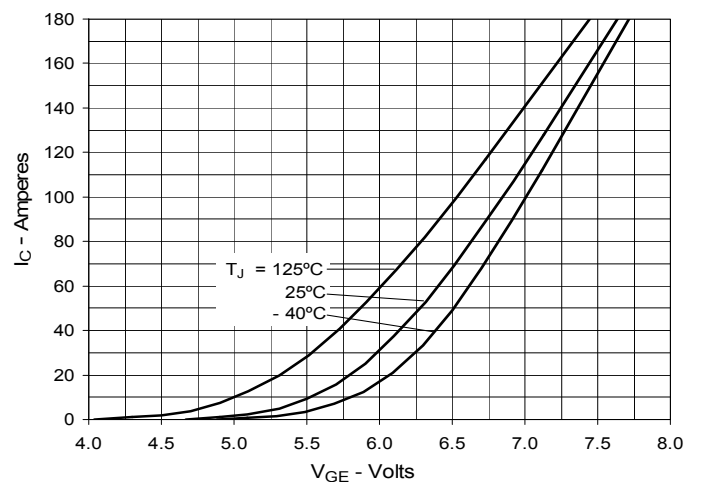

**Fig. 7. Transconductance**

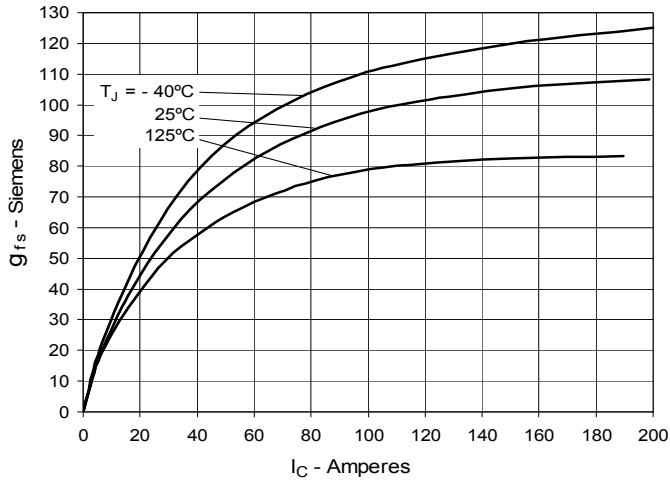

**Fig. 8. Gate Charge**

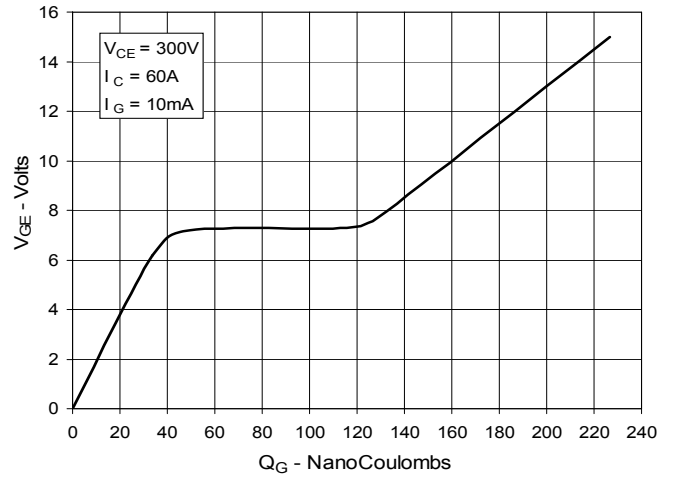

**Fig. 9. Capacitance**

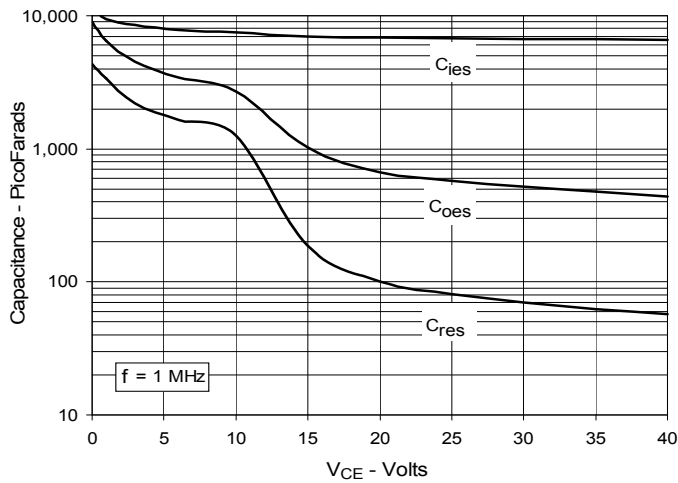

**Fig. 10. Reverse-Bias Safe Operating Area**

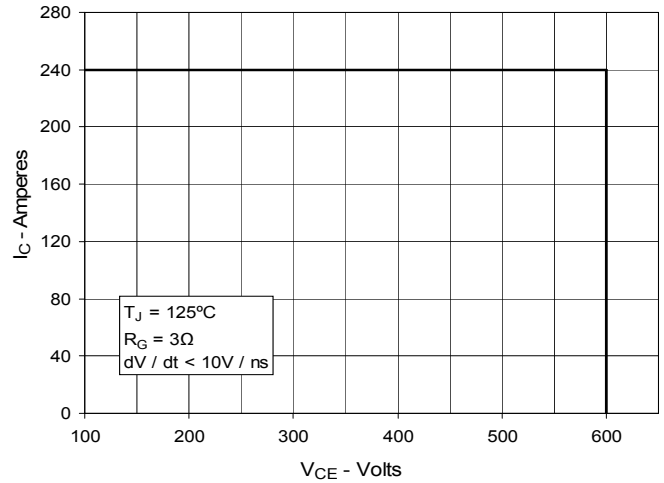

**Fig. 11. Maximum Transient Thermal Impedance**

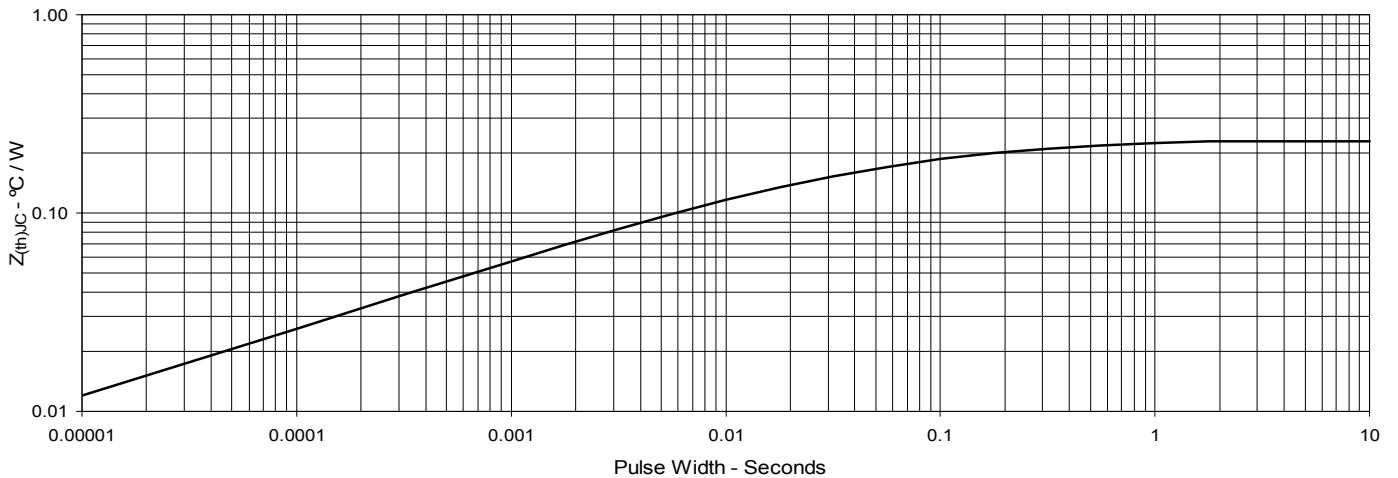

**Fig. 12. Inductive Switching Energy Loss vs. Gate Resistance**

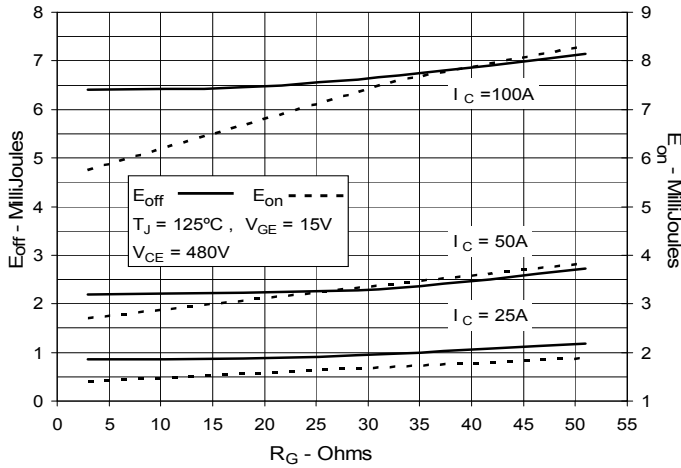

**Fig. 13. Inductive Switching Energy Loss vs. Collector Current**

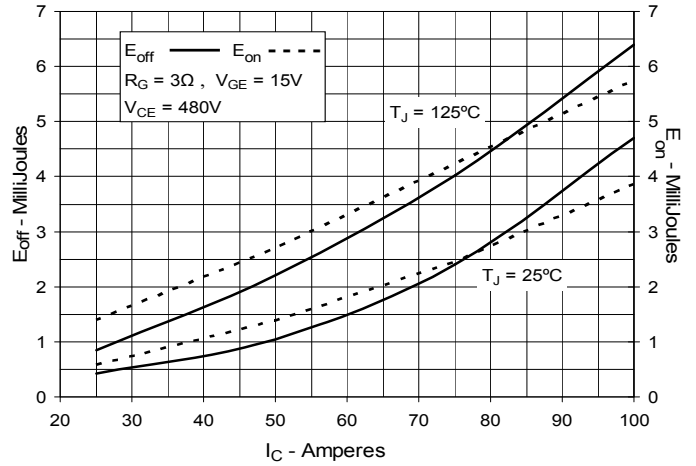

**Fig. 14. Inductive Switching Energy Loss vs. Junction Temperature**

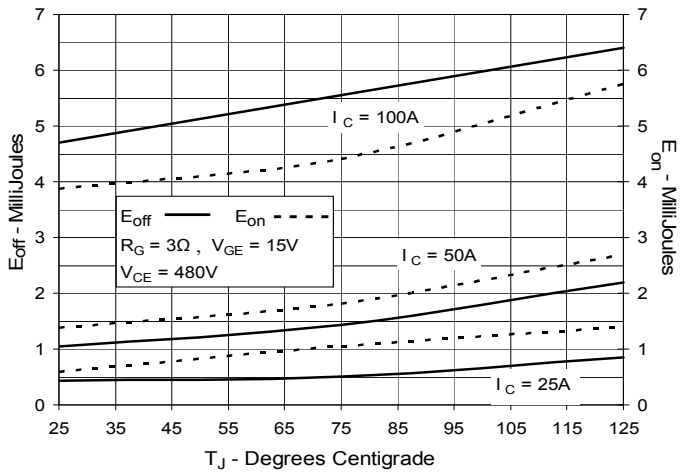

**Fig. 15. Inductive Turn-off Switching Times vs. Gate Resistance**

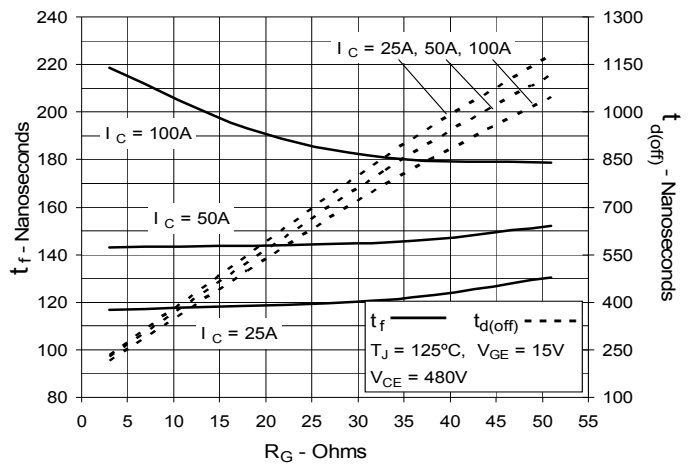

**Fig. 16. Inductive Turn-off Switching Times vs. Collector Current**

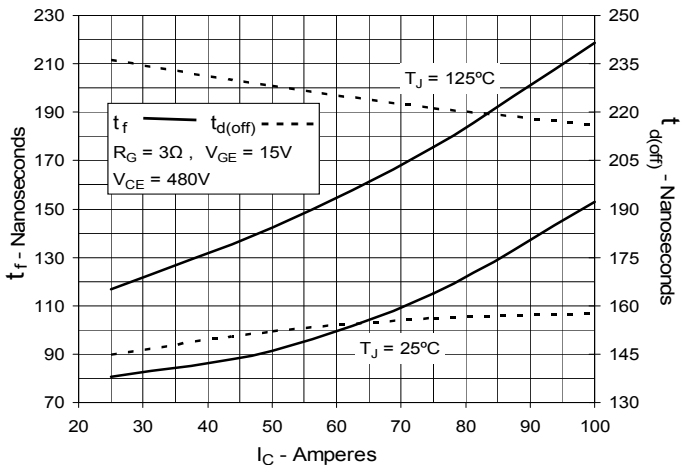

**Fig. 17. Inductive Turn-off Switching Times vs. Junction Temperature**

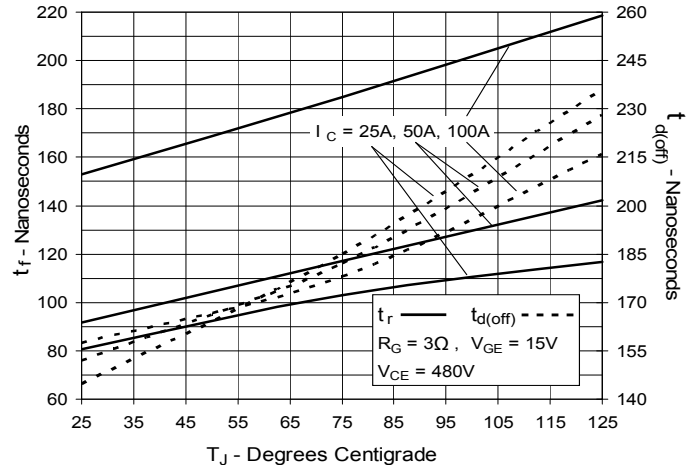

**Fig. 18. Inductive Turn-on Switching Times vs. Gate Resistance**

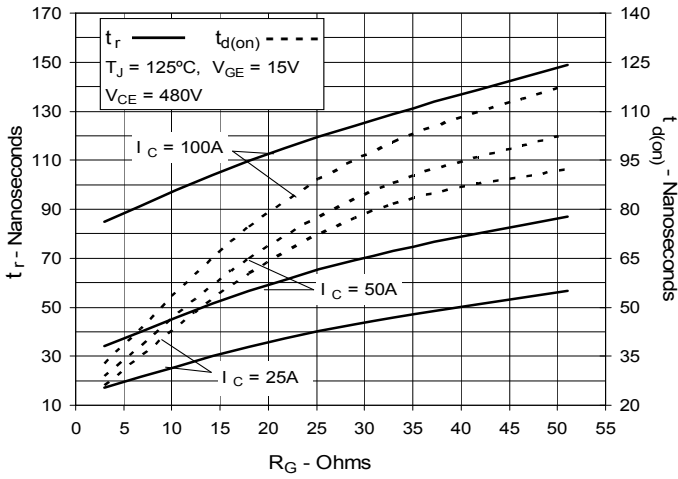

**Fig. 19. Inductive Turn-on Switching Times vs. Collector Current**

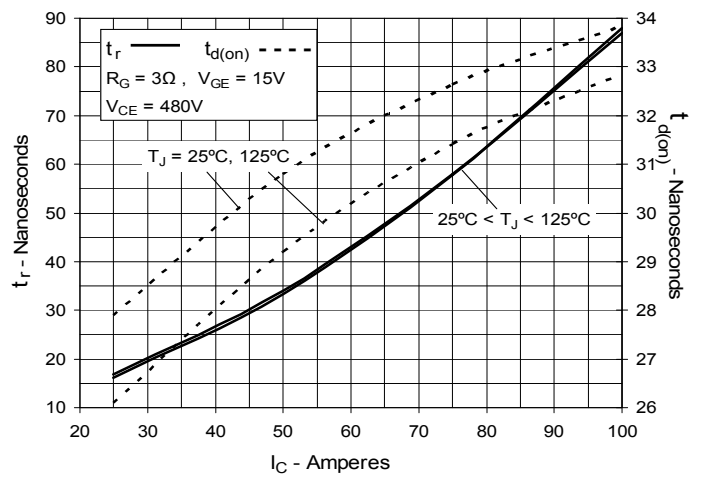

**Fig. 20. Inductive Turn-on Switching Times vs. Junction Temperature**

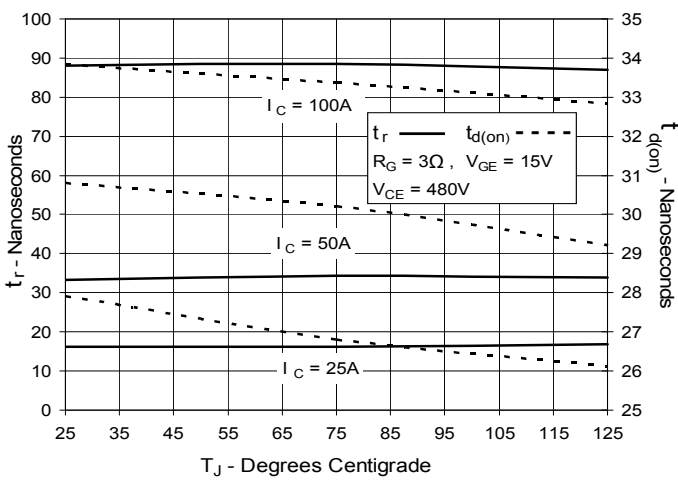

# Mouser Electronics

Authorized Distributor

Click to View Pricing, Inventory, Delivery & Lifecycle Information:

[IXYS:](#)

[IXGT72N60B3](#)