

MAX17505

4.5V-60V, 1.7A, High-Efficiency, Synchronous Step-Down DC-DC Converter With Internal Compensation

General Description

The MAX17505 high-efficiency, high-voltage, synchronously rectified step-down converter with dual integrated MOSFETs operates over a 4.5V to 60V input. It delivers up to 1.7A and 0.9V to 90% V_{IN} output voltage. Built-in compensation across the output voltage range eliminates the need for external components. The feedback (FB) regulation accuracy over -40°C to +125°C is $\pm 1.1\%$. The device is available in a compact (4mm x 4mm) TQFN lead(Pb)-free package with an exposed pad. Simulation models are available.

The device features a peak-current-mode control architecture with a MODE feature that can be used to operate the device in pulse-width modulation (PWM), pulse-frequency modulation (PFM), or discontinuous-conduction mode (DCM) control schemes. PWM operation provides constant frequency operation at all loads, and is useful in applications sensitive to switching frequency. PFM operation disables negative inductor current and additionally skips pulses at light loads for high efficiency. DCM features constant frequency operation down to lighter loads than PFM mode, by not skipping pulses but only disabling negative inductor current at light loads. DCM operation offers efficiency performance that lies between PWM and PFM modes. The low-resistance, on-chip MOSFETs ensure high efficiency at full load and simplify the layout.

A programmable soft-start feature allows users to reduce input inrush current. The device also incorporates an output enable/undervoltage lockout pin (EN/UVLO) that allows the user to turn on the part at the desired input-voltage level. An open-drain $\overline{\text{RESET}}$ pin provides a delayed power-good signal to the system upon achieving successful regulation of the output voltage.

Applications

- Industrial Power Supplies
- Distributed Supply Regulation
- Base Station Power Supplies
- Wall Transformer Regulation
- High-Voltage Single-Board Systems
- General-Purpose Point-of-Load

Benefits and Features

- Eliminates External Components and Reduces Total Cost
 - No Schottky-Synchronous Operation for High Efficiency and Reduced Cost
 - Internal Compensation for Stable Operation at Any Output Voltage
 - All-Ceramic Capacitor Solution: Ultra-Compact Layout with as Few as Eight External Components
- Reduces Number of DC-DC Regulators to Stock
 - Wide 4.5V to 60V Input Voltage Range
 - 0.9V to 90% V_{IN} Output Voltage
 - Delivers Up to 1.7A Over Temperature
 - 200kHz to 2.2MHz Adjustable Frequency with External Synchronization
 - Available in a 20-Pin, 4mm x 4mm TQFN Package
- Reduces Power Dissipation
 - Peak Efficiency > 90%
 - PFM and DCM Modes for High Light-Load Efficiency
 - Shutdown Current = 2.8 μ A (typ)
- Operates Reliably
 - Hiccup-Mode Current Limit and Autoretry Startup
 - Built-In Output-Voltage Monitoring (Open-Drain $\overline{\text{RESET}}$ Pin)
 - Resistor-Programmable EN/UVLO Threshold
 - Adjustable Soft-Start and Prebiased Power-Up
 - -40°C to +125°C Operation

Ordering Information appears at end of data sheet.

For related parts and recommended products to use with this part, refer to www.maximintegrated.com/MAX17505.related.

Visit www.maximintegrated.com/products/patents for product patent marking information.



Absolute Maximum Ratings

V_{IN} to PGND	-0.3V to +65V	LX Total RMS Current	±4A
EN/UVLO to SGND	-0.3V to +65V	Output Short-Circuit Duration	Continuous
LX to PGND.....	-0.3V to ($V_{IN} + 0.3V$)	Continuous Power Dissipation ($T_A = +70^{\circ}C$) (multilayer board)	
BST to PGND	-0.3V to +70V	TQFN (derate 30.3mW/°C above $T_A = +70^{\circ}C$)	2424.2mW
BST to LX.....	-0.3V to +6.5V	Operating Temperature Range.....	-40°C to +125°C
BST to V_{CC}	-0.3V to +65V	Junction Temperature.....	+150°C
FB, CF, RESET, SS, MODE, SYNC, RT to SGND	-0.3V to +6.5V	Storage Temperature Range.....	-65°C to +160°C
V_{CC} to SGND.....	-0.3V to +6.5V	Lead Temperature (soldering, 10s)	+300°C
SGND to PGND.....	-0.3V to +0.3V	Soldering Temperature (reflow).....	+260°C

Stresses beyond those listed under “Absolute Maximum Ratings” may cause permanent damage to the device. These are stress ratings only, and functional operation of the device at these or any other conditions beyond those indicated in the operational sections of the specifications is not implied. Exposure to absolute maximum rating conditions for extended periods may affect device reliability.

Package Thermal Characteristics (Note 1)

TQFN

Junction-to-Ambient Thermal Resistance (θ_{JA})	33°C/W
Junction-to-Case Thermal Resistance (θ_{JC}).....	2°C/W

Note 1: Package thermal resistances were obtained using the method described in JEDEC specification JESD51-7, using a four-layer board. For detailed information on package thermal considerations, refer to www.maximintegrated.com/thermal-tutorial.

Electrical Characteristics

($V_{IN} = V_{EN/UVLO} = 24V$, $R_{RT} = 40.2k\Omega$ (500kHz), $C_{VCC} = 2.2\mu F$, $V_{PGND} = V_{SGND} = V_{MODE} = V_{SYNC} = 0V$, LX = SS = RESET = open, V_{BST} to $V_{LX} = 5V$, $V_{FB} = 1V$, $T_A = T_J = -40^{\circ}C$ to $+125^{\circ}C$, unless otherwise noted. Typical values are at $T_A = +25^{\circ}C$. All voltages are referenced to SGND, unless otherwise noted.) (Note 2)

PARAMETER	SYMBOL	CONDITIONS	MIN	TYP	MAX	UNITS
INPUT SUPPLY (V_{IN})						
Input Voltage Range	V_{IN}		4.5		60	V
Input Shutdown Current	I_{IN-SH}	$V_{EN/UVLO} = 0V$ (shutdown mode)		2.8	4.5	μA
Input Quiescent Current	I_{Q_PFM}	$V_{FB} = 1V$, MODE = RT = open		118		
		$V_{FB} = 1V$, MODE = open		162		
	I_{Q_DCM}	DCM mode, $V_{LX} = 0.1V$	1.16		1.8	mA
I_{Q_PWM}	Normal switching mode, $f_{SW} = 500kHz$, $V_{FB} = 0.8V$		9.5			
ENABLE/UVLO (EN/UVLO)						
EN/UVLO Threshold	V_{ENR}	$V_{EN/UVLO}$ rising	1.19	1.215	1.24	V
	V_{ENF}	$V_{EN/UVLO}$ falling	1.068	1.09	1.111	
EN/UVLO Input Leakage Current	I_{EN}	$V_{EN/UVLO} = 0V$, $T_A = +25^{\circ}C$	-50	0	+50	nA
LDO						
V_{CC} Output Voltage Range	V_{CC}	$6V < V_{IN} < 60V$, $I_{VCC} = 1mA$	4.75	5	5.25	V
		$1mA \leq I_{VCC} \leq 25mA$				
V_{CC} Current Limit	$I_{VCC-MAX}$	$V_{CC} = 4.3V$, $V_{IN} = 6V$	26.5	54	100	mA
V_{CC} Dropout	V_{CC-DO}	$V_{IN} = 4.5V$, $I_{VCC} = 20mA$	4.2			V
V_{CC} UVLO	V_{CC_UVR}	V_{CC} rising	4.05	4.2	4.3	V
	V_{CC_UVF}	V_{CC} falling	3.65	3.8	3.9	

Electrical Characteristics (continued)

($V_{IN} = V_{EN/UVLO} = 24V$, $R_{RT} = 40.2k\Omega$ (500kHz), $C_{VCC} = 2.2\mu F$, $V_{PGND} = V_{SGND} = V_{MODE} = V_{SYNC} = 0V$, $LX = SS = \overline{RESET} = \text{open}$, V_{BST} to $V_{LX} = 5V$, $V_{FB} = 1V$, $T_A = T_J = -40^\circ C$ to $+125^\circ C$, unless otherwise noted. Typical values are at $T_A = +25^\circ C$. All voltages are referenced to SGND, unless otherwise noted.) (Note 2)

PARAMETER	SYMBOL	CONDITIONS	MIN	TYP	MAX	UNITS
POWER MOSFET AND BST DRIVER						
High-Side nMOS On-Resistance	R_{DS-ONH}	$I_{LX} = 0.3A$		165	325	m Ω
Low-Side nMOS On-Resistance	R_{DS-ONL}	$I_{LX} = 0.3A$		80	150	m Ω
LX Leakage Current	I_{LX_LKG}	$V_{LX} = V_{IN} - 1V$, $V_{LX} = V_{PGND} + 1V$, $T_A = +25^\circ C$	-2		+2	μA
SOFT-START (SS)						
Charging Current	I_{SS}	$V_{SS} = 0.5V$	4.7	5	5.3	μA
FEEDBACK (FB)						
FB Regulation Voltage	V_{FB_REG}	MODE = SGND or V_{CC}	0.89	0.9	0.91	V
		MODE = OPEN	0.89	0.915	0.936	
FB Input Bias Current	I_{FB}	$0 < V_{FB} < 1V$, $T_A = +25^\circ C$	-50		+50	nA
MODE						
MODE Threshold	V_{M-DCM}	MODE = V_{CC} (DCM mode)	$V_{CC} - 1.6$			V
	V_{M-PFM}	MODE = open (PFM mode)	$V_{CC} / 2$			
	V_{M-PWM}	MODE = GND (PWM mode)	1.4			
CURRENT LIMIT						
Peak Current-Limit Threshold	$I_{PEAK-LIMIT}$		2.4	2.8	3.25	A
Runaway Current-Limit Threshold	$I_{RUNAWAY-LIMIT}$		2.9	3.4	3.9	A
Valley Current-Limit Threshold	$I_{SINK-LIMIT}$	MODE = open/ V_{CC}	-0.16	0	+0.16	A
		MODE = GND		-1.8		
PFM Current-Limit Threshold	I_{PFM}	MODE = open	0.6	0.75	0.9	A
RT AND SYNC						
Switching Frequency	f_{SW}	$R_{RT} = 102k\Omega$	180	200	220	kHz
		$R_{RT} = 40.2k\Omega$	475	500	525	
		$R_{RT} = 8.06k\Omega$	1950	2200	2450	
		$R_{RT} = \text{open}$	460	500	540	
SYNC Frequency Capture Range		f_{SW} set by R_{RT}	1.1 x f_{SW}		1.4 x f_{SW}	kHz

Electrical Characteristics (continued)

($V_{IN} = V_{EN/UVLO} = 24V$, $R_{RT} = 40.2k\Omega$ (500kHz), $C_{VCC} = 2.2\mu F$, $V_{PGND} = V_{SGND} = V_{MODE} = V_{SYNC} = 0V$, $LX = SS = \overline{RESET} = \text{open}$, V_{BST} to $V_{LX} = 5V$, $V_{FB} = 1V$, $T_A = T_J = -40^\circ C$ to $+125^\circ C$, unless otherwise noted. Typical values are at $T_A = +25^\circ C$. All voltages are referenced to SGND, unless otherwise noted.) (Note 2)

PARAMETER	SYMBOL	CONDITIONS	MIN	TYP	MAX	UNITS
SYNC Pulse Width			50			ns
SYNC Threshold	V_{IH}		2.1			V
	V_{IL}				0.8	
FB Undervoltage Trip Level to Cause Hiccup	$V_{FB-HICF}$		0.56	0.58	0.6	V
Hiccup Timeout		(Note 3)		32,768		Cycles
Minimum On-Time	t_{ON-MIN}				135	ns
Minimum Off-Time	$t_{OFF-MIN}$		140		160	ns
LX Dead Time				5		ns
\overline{RESET}						
\overline{RESET} Output Level Low		$I_{\overline{RESET}} = 10mA$			0.4	V
\overline{RESET} Output Leakage Current		$T_A = T_J = +25^\circ C$, $V_{\overline{RESET}} = 5.5V$	-0.1		+0.1	μA
FB Threshold for \overline{RESET} Assertion	V_{FB-OKF}	V_{FB} falling	90.5	92	94	$\%V_{FB-REG}$
FB Threshold for \overline{RESET} Deassertion	V_{FB-OKR}	V_{FB} rising	93.8	95	97.2	$\%V_{FB-REG}$
\overline{RESET} Deassertion Delay After FB Reaches 95% Regulation				1024		Cycles
THERMAL SHUTDOWN						
Thermal-Shutdown Threshold		Temperature rising		165		$^\circ C$
Thermal-Shutdown Hysteresis				10		$^\circ C$

Note 2: All limits are 100% tested at $+25^\circ C$. Limits over temperature are guaranteed by design.

Note 3: See the [Overcurrent Protection/Hiccup Mode](#) section for more details.

Typical Operating Characteristics

($V_{IN} = V_{EN}/UVLO = 24V$, $V_{PGND} = V_{SGND} = 0V$, $C_{VIN} = C_{VCC} = 2.2\mu F$, $C_{BST} = 0.1\mu F$, $C_{SS} = 5600pF$, $RT = MODE = open$, $T_A = T_J = -40^\circ C$ to $+125^\circ C$, unless otherwise noted. Typical values are at $T_A = +25^\circ C$. All voltages are referenced to GND, unless otherwise noted.)

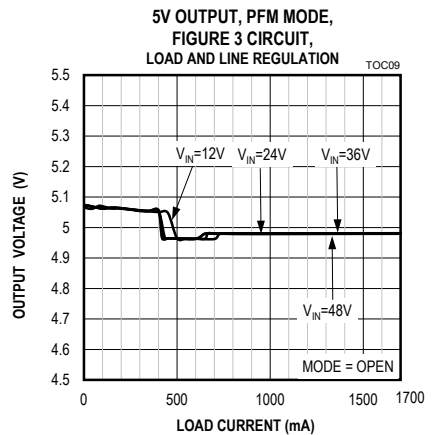
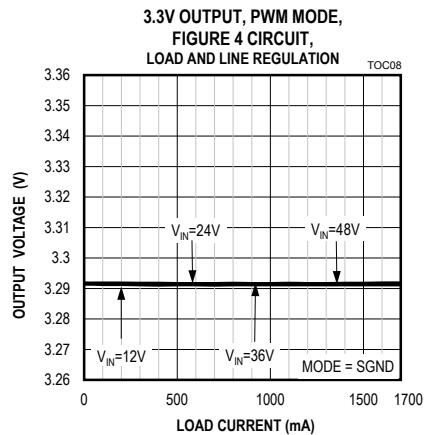
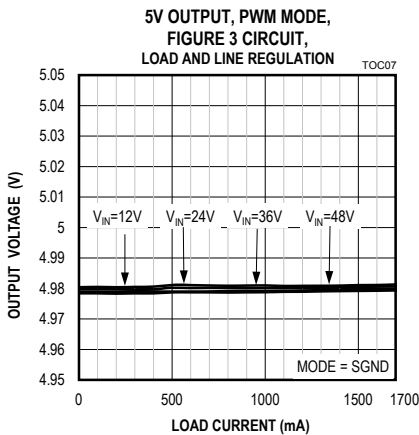
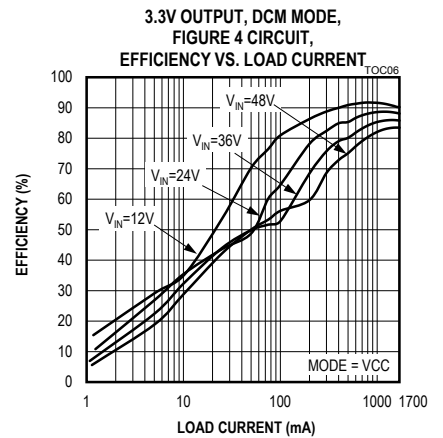
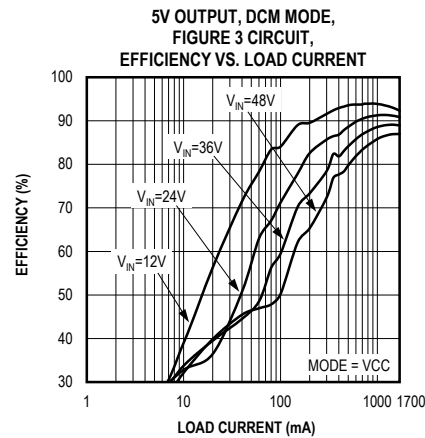
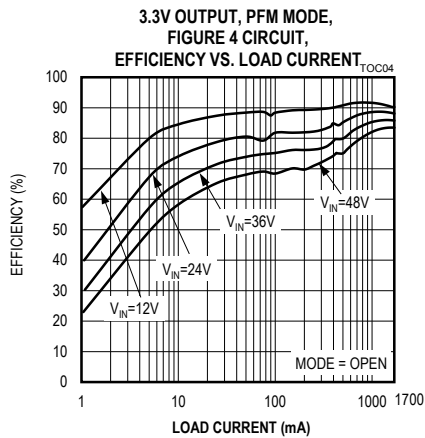
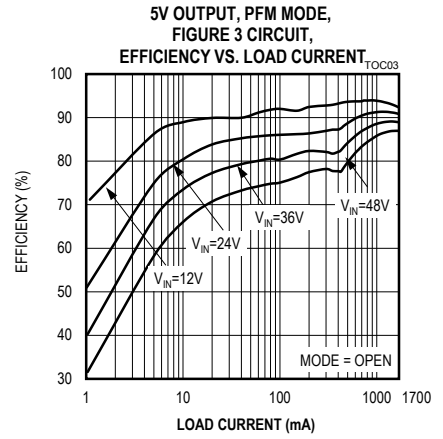
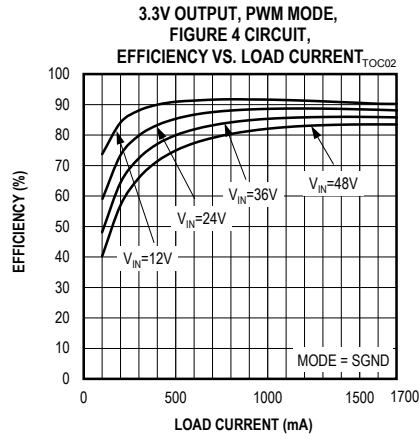
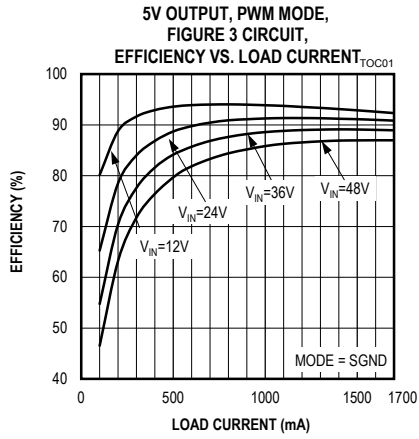

Typical Operating Characteristics (continued)

($V_{IN} = V_{EN/UVLO} = 24V$, $V_{PGND} = V_{SGND} = 0V$, $C_{VIN} = C_{VCC} = 2.2\mu F$, $C_{BST} = 0.1\mu F$, $C_{SS} = 5600pF$, $R_T = MODE = open$, $T_A = T_J = -40^\circ C$ to $+125^\circ C$, unless otherwise noted. Typical values are at $T_A = +25^\circ C$. All voltages are referenced to GND, unless otherwise noted.)

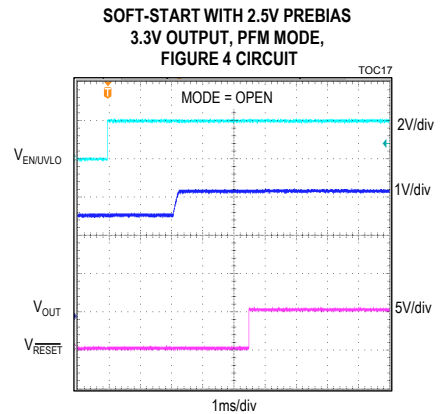
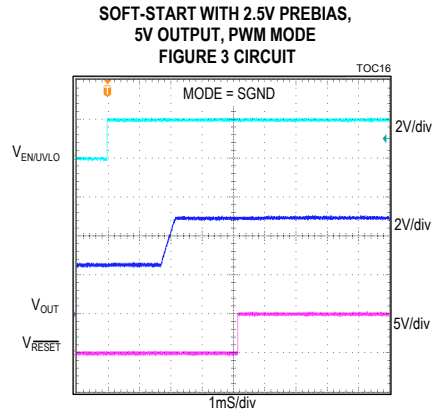
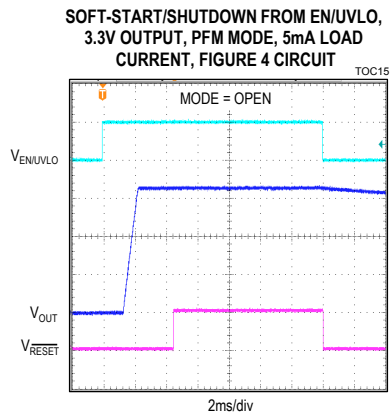
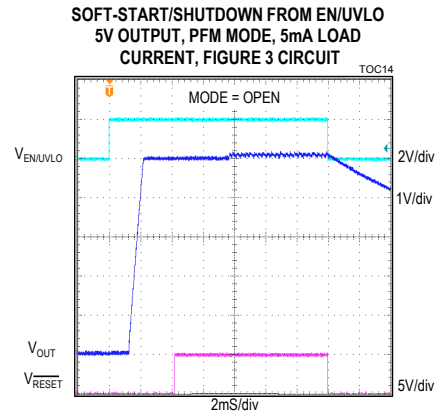
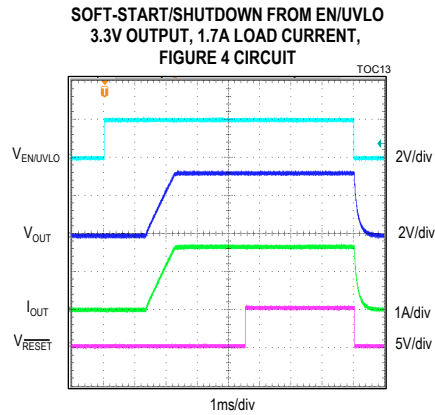
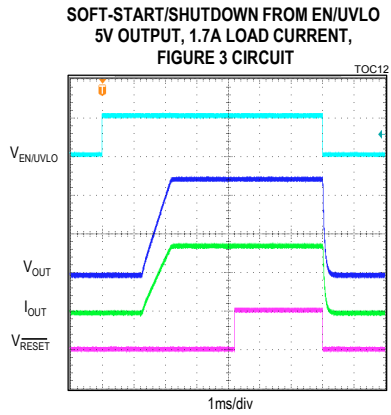
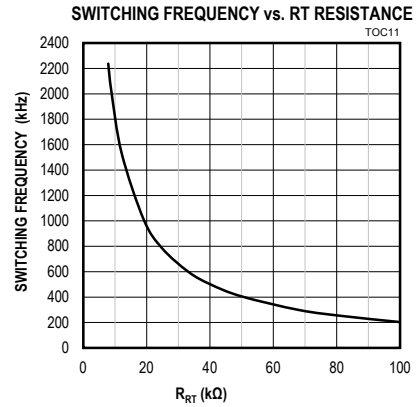
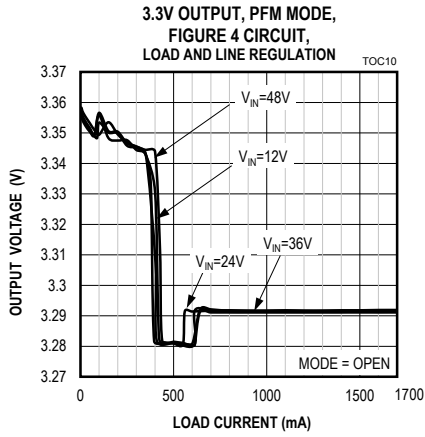

Typical Operating Characteristics (continued)

($V_{IN} = V_{EN}/UVLO = 24V$, $V_{PGND} = V_{SGND} = 0V$, $C_{VIN} = C_{VCC} = 2.2\mu F$, $C_{BST} = 0.1\mu F$, $C_{SS} = 5600pF$, $RT = MODE = open$, $T_A = T_J = -40^\circ C$ to $+125^\circ C$, unless otherwise noted. Typical values are at $T_A = +25^\circ C$. All voltages are referenced to GND, unless otherwise noted.)

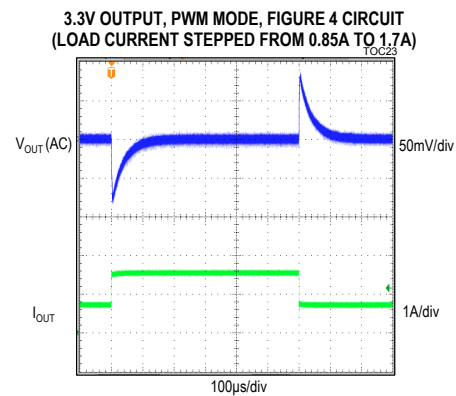
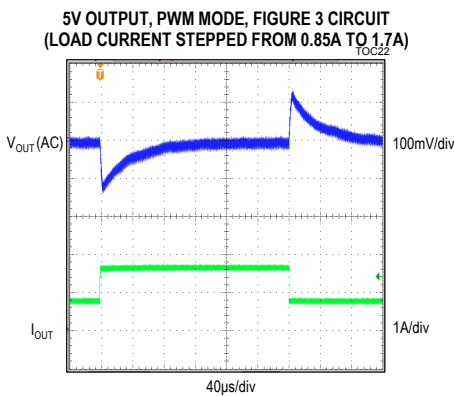
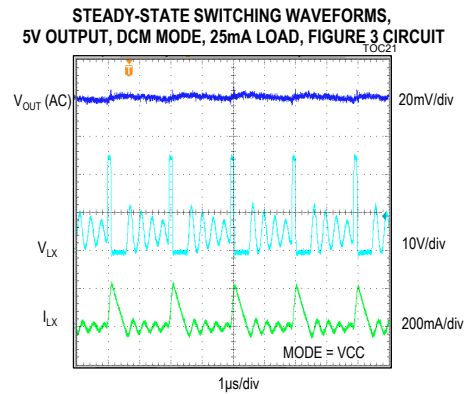
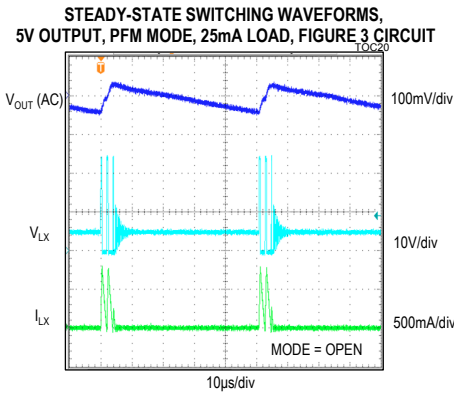
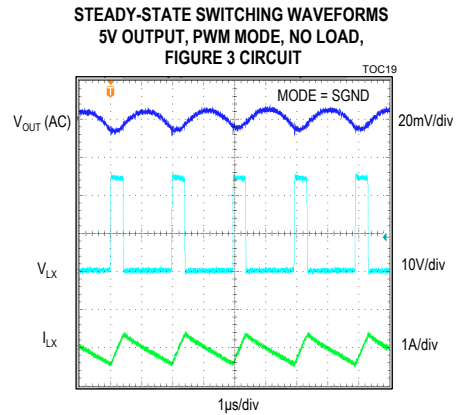
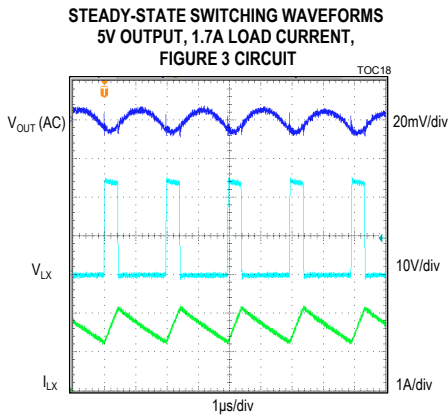

Typical Operating Characteristics (continued)

($V_{IN} = V_{EN}/V_{VLO} = 24V$, $V_{PGND} = V_{SGND} = 0V$, $C_{VIN} = C_{VCC} = 2.2\mu F$, $C_{BST} = 0.1\mu F$, $C_{SS} = 5600pF$, $RT = MODE = open$, $T_A = T_J = -40^\circ C$ to $+125^\circ C$, unless otherwise noted. Typical values are at $T_A = +25^\circ C$. All voltages are referenced to GND, unless otherwise noted.)

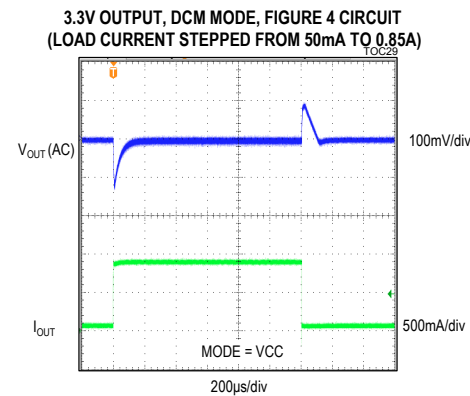
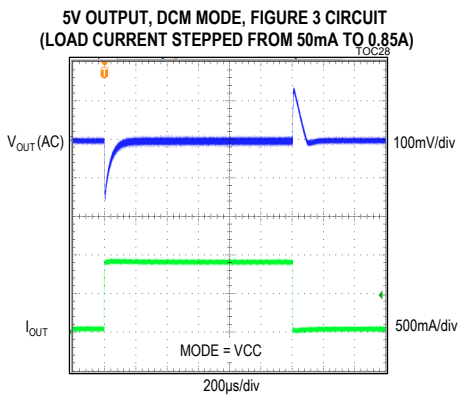
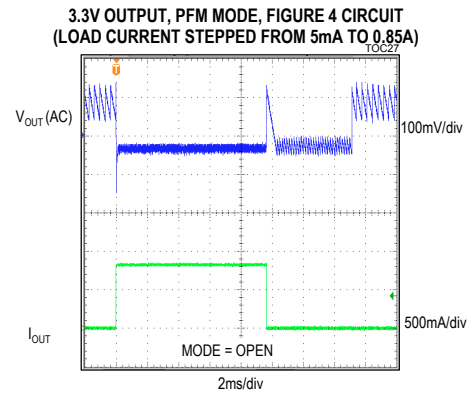
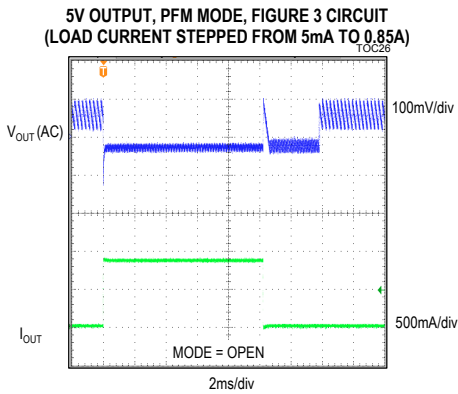
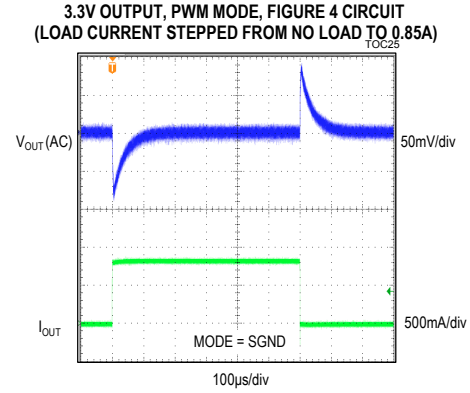
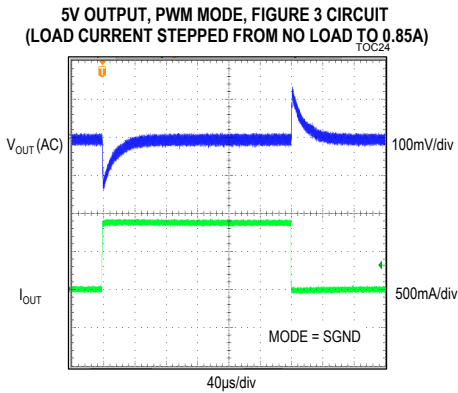

Typical Operating Characteristics (continued)

($V_{IN} = V_{EN}/V_{VLO} = 24V$, $V_{PGND} = V_{SGND} = 0V$, $C_{VIN} = C_{VCC} = 2.2\mu F$, $C_{BST} = 0.1\mu F$, $C_{SS} = 5600pF$, $RT = MODE = open$, $T_A = T_J = -40^\circ C$ to $+125^\circ C$, unless otherwise noted. Typical values are at $T_A = +25^\circ C$. All voltages are referenced to GND, unless otherwise noted.)

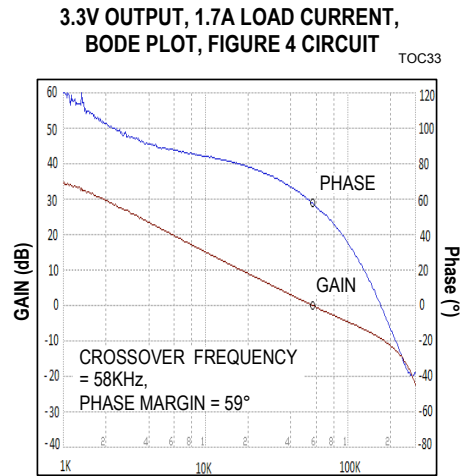
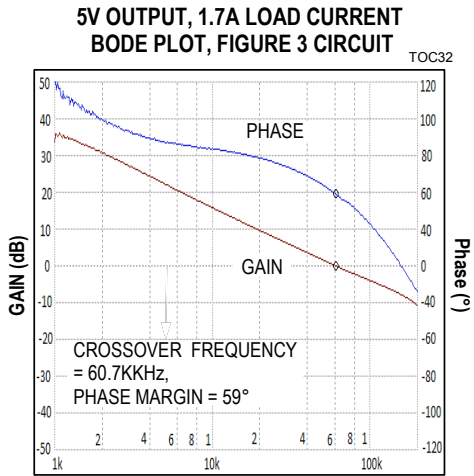
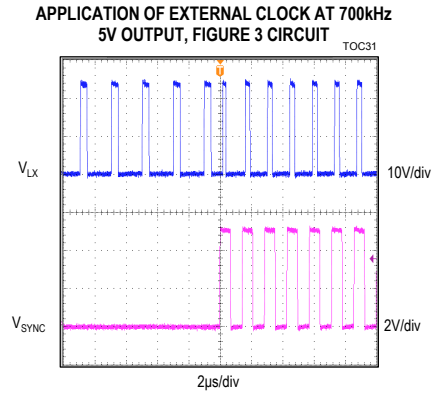
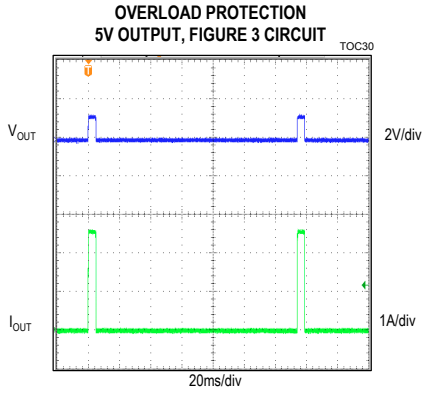

Pin Configuration

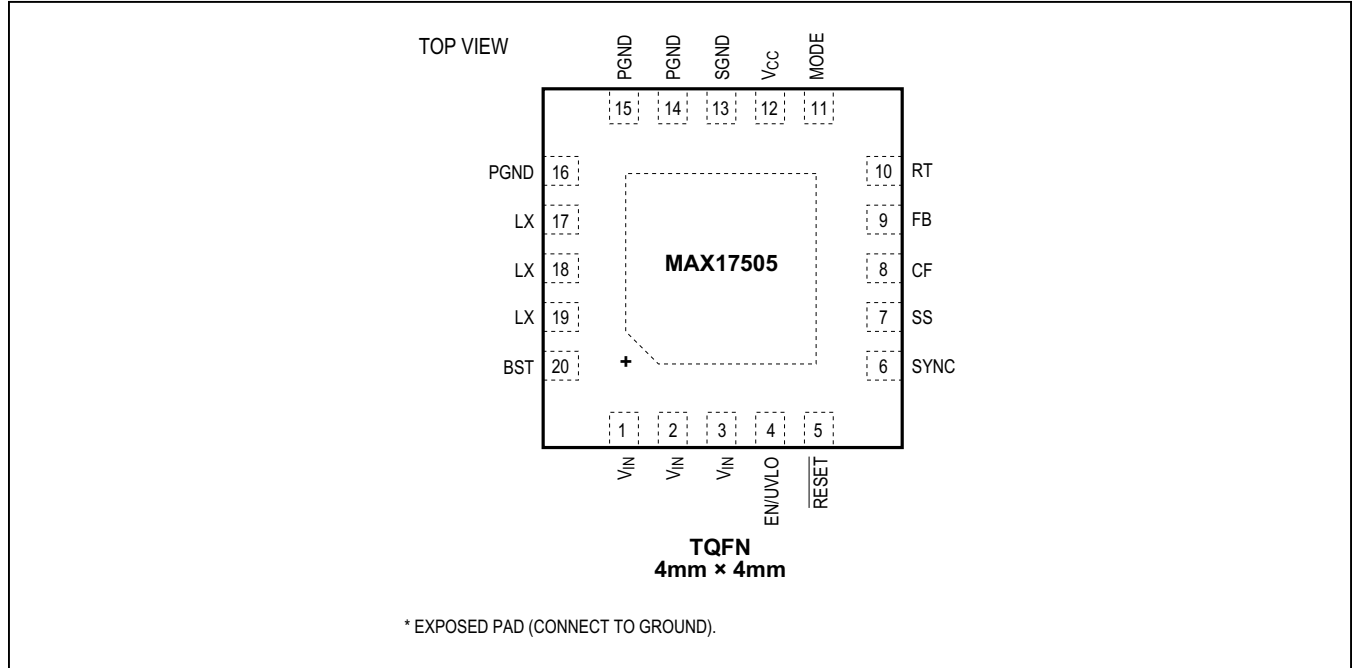

Pin Description

PIN	NAME	FUNCTION
1-3	V _{IN}	Power-Supply Input. 4.5V to 60V input supply range. Connect the V _{IN} pins together. Decouple to PGND with a 2.2μF capacitor; place the capacitor close to the V _{IN} and PGND pins. Refer to the MAX17505 EV kit data sheet for a layout example.
4	EN/UVLO	Enable/Undervoltage Lockout. Drive EN/UVLO high to enable the output voltage. Connect to the center of the resistor-divider between V _{IN} and SGND to set the input voltage at which the device turns on. Pull up to V _{IN} for always-on operation.
5	RESET	Open-Drain RESET Output. The RESET output is driven low if FB drops below 92% of its set value. RESET goes high 1024 clock cycles after FB rises above 95% of its set value.
6	SYNC	The device can be synchronized to an external clock using this pin. See the <i>External Frequency Synchronization</i> section for more details.
7	SS	Soft-Start Input. Connect a capacitor from SS to SGND to set the soft-start time.
8	CF	At switching frequencies lower than 500kHz, connect a capacitor from CF to FB. Leave CF open if switching frequency is equal or more than 500kHz. See the <i>Loop Compensation</i> section for more details.
9	FB	Feedback Input. Connect FB to the center tap of an external resistor-divider from the output to GND to set the output voltage. See the <i>Adjusting Output Voltage</i> section for more details.
10	RT	Connect a resistor from RT to SGND to set the regulator's switching frequency. Leave RT open for the default 500kHz frequency. See the <i>Setting the Switching Frequency (RT)</i> section for more details.
11	MODE	MODE pin configures the device to operate either in PWM, PFM, or DCM modes of operation. Leave MODE unconnected for PFM operation (pulse skipping at light loads). Connect MODE to SGND for constant-frequency PWM operation at all loads. Connect MODE to V _{CC} for DCM operation. See the <i>MODE Setting</i> section for more details.

Pin Description (continued)

PIN	NAME	FUNCTION
12	V _{CC}	5V LDO Output. Bypass V _{CC} with 2.2μF ceramic capacitance to SGND.
13	SGND	Analog Ground
14–16	PGND	Power Ground. Connect the PGND pins externally to the power ground plane. Connect the SGND and PGND pins together at the ground return path of the V _{CC} bypass capacitor. Refer to the MAX17505 EV kit data sheet for a layout example.
17–19	LX	Switching Node. Connect LX pins to the switching side of the inductor. Refer to the MAX17505 EV kit data sheet for a layout example.
20	BST	Boost Flying Capacitor. Connect a 0.1μF ceramic capacitor between BST and LX.
—	EP	Exposed pad. Connect to the SGND pin. Connect to a large copper plane below the IC to improve heat dissipation capability. Add thermal vias below the exposed pad. Refer to the MAX17505 EV kit data sheet for a layout example.

Block Diagram

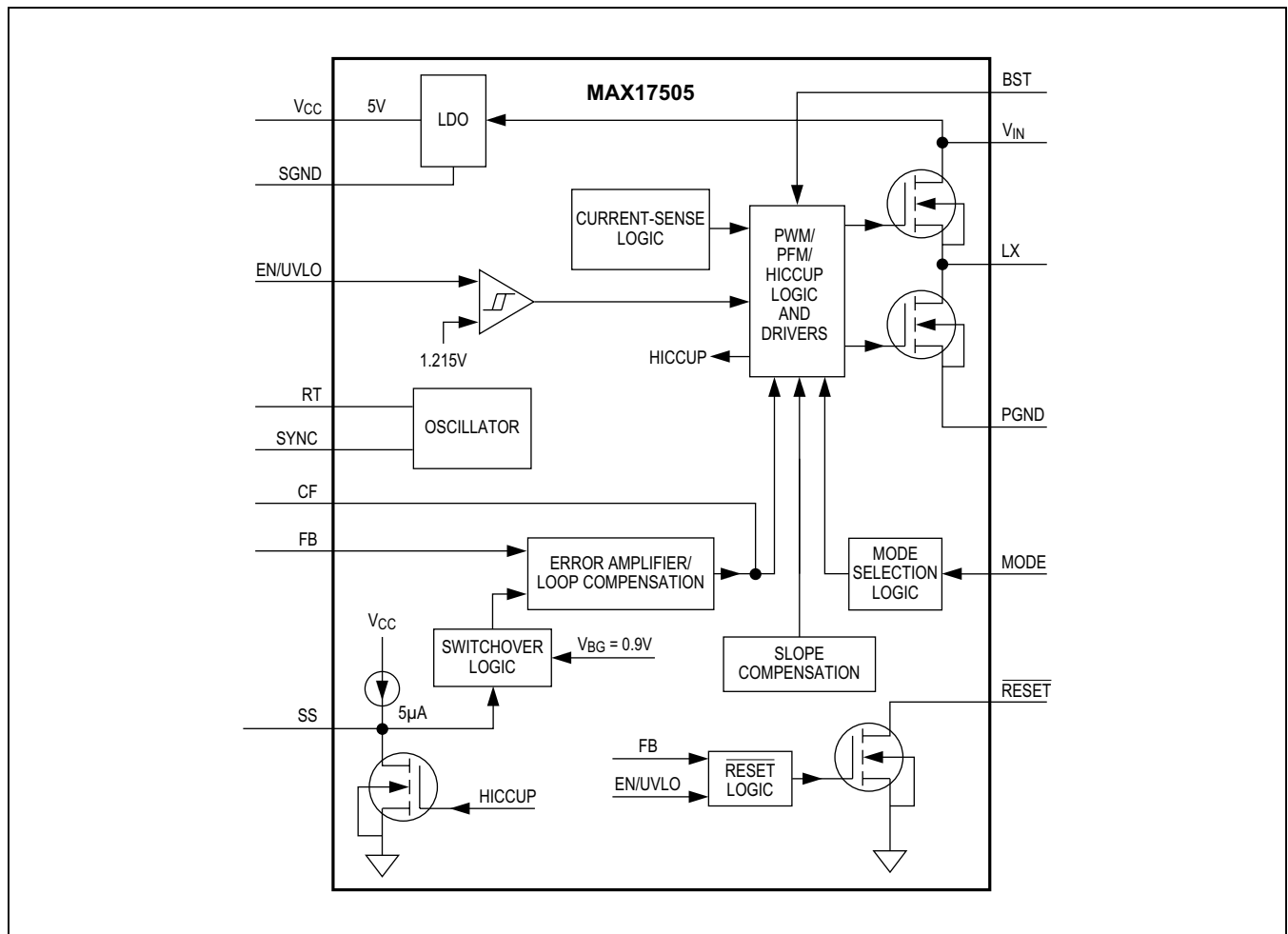

Detailed Description

The MAX17505 high-efficiency, high-voltage, synchronously rectified step-down converter with dual integrated MOSFETs operates over a 4.5V to 60V input. It delivers up to 1.7A and 0.9V to 90% V_{IN} output voltage. Built-in compensation across the output voltage range eliminates the need for external components. The feedback (FB) regulation accuracy over -40°C to +125°C is $\pm 1.1\%$.

The device features a peak-current-mode control architecture. An internal transconductance error amplifier produces an integrated error voltage at an internal node, which sets the duty cycle using a PWM comparator, a high-side current-sense amplifier, and a slope-compensation generator. At each rising edge of the clock, the high-side MOSFET turns on and remains on until either the appropriate or maximum duty cycle is reached, or the peak current limit is detected. During the high-side MOSFET's on-time, the inductor current ramps up. During the second half of the switching cycle, the high-side MOSFET turns off and the low-side MOSFET turns on. The inductor releases the stored energy as its current ramps down and provides current to the output.

The device features a MODE pin that can be used to operate the device in PWM, PFM, or DCM control schemes. The device integrates adjustable-input undervoltage lockout, adjustable soft-start, open RESET, and external frequency synchronization features.

Mode Selection (MODE)

The logic state of the MODE pin is latched when V_{CC} and EN/UVLO voltages exceed the respective UVLO rising thresholds and all internal voltages are ready to allow LX switching. If the MODE pin is open at power-up, the device operates in PFM mode at light loads. If the MODE pin is grounded at power-up, the device operates in constant-frequency PWM mode at all loads. Finally, if the MODE pin is connected to V_{CC} at power-up, the device operates in constant-frequency DCM mode at light loads. State changes on the MODE pin are ignored during normal operation.

PWM Mode Operation

In PWM mode, the inductor current is allowed to go negative. PWM operation provides constant frequency operation at all loads, and is useful in applications sensitive to switching frequency. However, the PWM mode of operation gives lower efficiency at light loads compared to PFM and DCM modes of operation.

PFM Mode Operation

PFM mode of operation disables negative inductor current and additionally skips pulses at light loads for high efficiency. In PFM mode, the inductor current is forced to a fixed peak of 750mA every clock cycle until the output rises to 102.3% of the nominal voltage. Once the output reaches 102.3% of the nominal voltage, both the high-side and low-side FETs are turned off and the device enters hibernate operation until the load discharges the output to 101.1% of the nominal voltage. Most of the internal blocks are turned off in hibernate operation to save quiescent current. After the output falls below 101.1% of the nominal voltage, the device comes out of hibernate operation, turns on all internal blocks, and again commences the process of delivering pulses of energy to the output until it reaches 102.3% of the nominal output voltage.

The advantage of the PFM mode is higher efficiency at light loads because of lower quiescent current drawn from supply. The disadvantage is that the output-voltage ripple is higher compared to PWM or DCM modes of operation and switching frequency is not constant at light loads.

DCM Mode Operation

DCM mode of operation features constant frequency operation down to lighter loads than PFM mode, by not skipping pulses but only disabling negative inductor current at light loads. DCM operation offers efficiency performance that lies between PWM and PFM modes.

Linear Regulator (V_{CC})

An internal linear regulator (V_{CC}) provides a 5V nominal supply to power the internal blocks and the low-side MOSFET driver. The output of the linear regulator (V_{CC}) should be bypassed with a 2.2 μ F ceramic capacitor to SGND. The device employs an undervoltage lockout circuit that disables the internal linear regulator when V_{CC} falls below 3.8V (typ).

Setting the Switching Frequency (RT)

The switching frequency of the device can be programmed from 200kHz to 2.2MHz by using a resistor connected from the RT pin to SGND. The switching frequency (f_{SW}) is related to the resistor connected at the RT pin (R_{RT}) by the following equation:

$$R_{RT} \cong \frac{21 \times 10^3}{f_{SW}} - 1.7$$

where R_{RT} is in k Ω and f_{SW} is in kHz. Leaving the RT pin open causes the device to operate at the default switching frequency of 500kHz. See [Table 1](#) for RT resistor values for a few common switching frequencies.

Table 1. Switching Frequency vs. RT Resistor

SWITCHING FREQUENCY (kHz)	RT RESISTOR (kΩ)
500	Open
200	102
400	49.9
1000	19.1
2200	8.06

Operating Input Voltage Range

The minimum and maximum operating input voltages for a given output voltage should be calculated as follows:

$$V_{IN(MIN)} = \frac{V_{OUT} + (I_{OUT(MAX)} \times (R_{DCR} + 0.15))}{1 - (f_{SW(MAX)} \times t_{OFF(MAX)})} + (I_{OUT(MAX)} \times 0.175)$$

$$V_{IN(MAX)} = \frac{V_{OUT}}{f_{SW(MAX)} \times t_{ON(MIN)}}$$

where V_{OUT} is the steady-state output voltage, $I_{OUT(MAX)}$ is the maximum load current, R_{DCR} is the DC resistance of the inductor, $f_{SW(MAX)}$ is the maximum switching frequency, $t_{OFF-MAX}$ is the worst-case minimum switch off-time (160ns), and t_{ON-MIN} is the worst-case minimum switch on-time (135ns).

External Frequency Synchronization (SYNC)

The internal oscillator of the device can be synchronized to an external clock signal on the SYNC pin. The external synchronization clock frequency must be between $1.1 \times f_{SW}$ and $1.4 \times f_{SW}$, where f_{SW} is the frequency programmed by the RT resistor. The minimum external clock pulse-width high should be greater than 50ns. See the RT AND SYNC section in the *Electrical Characteristics* table for details.

Overcurrent Protection/Hiccup Mode

The device is provided with a robust overcurrent protection scheme that protects the device under overload and output short-circuit conditions. A cycle-by-cycle peak current limit turns off the high-side MOSFET whenever the high-side switch current exceeds an internal limit of 2.8A (typ). A runaway current limit on the high-side

switch current at 3.4A (typ) protects the device under high input voltage, short-circuit conditions when there is insufficient output voltage available to restore the inductor current that was built up during the ON period of the step-down converter. One occurrence of the runaway current limit triggers a hiccup mode. In addition, if due to a fault condition, feedback voltage drops to 0.58V (typ) any time after soft-start is complete, and hiccup mode is triggered. In hiccup mode, the converter is protected by suspending switching for a hiccup timeout period of 32,768 clock cycles. Once the hiccup timeout period expires, soft-start is attempted again. Note that when soft-start is attempted under overload condition, if feedback voltage does not exceed 0.58V, the device switches at half the programmed switching frequency. Hiccup mode of operation ensures low power dissipation under output short-circuit conditions.

RESET Output

The device includes a \overline{RESET} comparator to monitor the output voltage. The open-drain \overline{RESET} output requires an external pullup resistor. \overline{RESET} goes high (high impedance) 1024 switching cycles after the regulator output increases above 95% of the designed nominal regulated voltage. \overline{RESET} goes low when the regulator output voltage drops to below 92% of the nominal regulated voltage. \overline{RESET} also goes low during thermal shutdown.

Prebiased Output

When the device starts into a prebiased output, both the high-side and the low-side switches are turned off so that the converter does not sink current from the output. High-side and low-side switches do not start switching until the PWM comparator commands the first PWM pulse, at which point switching commences. The output voltage is then smoothly ramped up to the target value in alignment with the internal reference.

Thermal-Shutdown Protection

Thermal-shutdown protection limits total power dissipation in the device. When the junction temperature of the device exceeds +165°C, an on-chip thermal sensor shuts down the device, allowing the device to cool. The thermal sensor turns the device on again after the junction temperature cools by 10°C. Soft-start resets during thermal shutdown. Carefully evaluate the total power dissipation (see the [Power Dissipation](#) section) to avoid unwanted triggering of the thermal shutdown in normal operation.

Applications Information

Input Capacitor Selection

The input filter capacitor reduces peak currents drawn from the power source and reduces noise and voltage ripple on the input caused by the circuit's switching. The input capacitor RMS current requirement (I_{RMS}) is defined by the following equation:

$$I_{RMS} = I_{OUT(MAX)} \times \frac{\sqrt{V_{OUT} \times (V_{IN} - V_{OUT})}}{V_{IN}}$$

where, $I_{OUT(MAX)}$ is the maximum load current. I_{RMS} has a maximum value when the input voltage equals twice the output voltage ($V_{IN} = 2 \times V_{OUT}$), so $I_{RMS(MAX)} = I_{OUT(MAX)}/2$.

Choose an input capacitor that exhibits less than +10°C temperature rise at the RMS input current for optimal long-term reliability. Use low-ESR ceramic capacitors with high-ripple-current capability at the input. X7R capacitors are recommended in industrial applications for their temperature stability. Calculate the input capacitance using the following equation:

$$C_{IN} = \frac{I_{OUT(MAX)} \times D \times (1-D)}{\eta \times f_{SW} \times \Delta V_{IN}}$$

where $D = V_{OUT}/V_{IN}$ is the duty ratio of the controller, f_{SW} is the switching frequency, ΔV_{IN} is the allowable input voltage ripple, and η is the efficiency.

In applications where the source is located distant from the device input, an electrolytic capacitor should be added in parallel to the ceramic capacitor to provide necessary damping for potential oscillations caused by the inductance of the longer input power path and input ceramic capacitor.

Inductor Selection

Three key inductor parameters must be specified for operation with the device: inductance value (L), inductor saturation current (I_{SAT}), and DC resistance (R_{DCR}). The switching frequency and output voltage determine the inductor value as follows:

$$L = \frac{V_{OUT}}{f_{SW}}$$

where V_{OUT} , and f_{SW} are nominal values. Select an inductor whose value is nearest to the value calculated by the previous formula.

Select a low-loss inductor closest to the calculated value with acceptable dimensions and having the lowest possible DC resistance. The saturation current rating (I_{SAT}) of the inductor must be high enough to ensure that

saturation can occur only above the peak current-limit value of 2.8A.

Output Capacitor Selection

X7R ceramic output capacitors are preferred due to their stability over temperature in industrial applications. The output capacitors are usually sized to support a step load of 50% of the maximum output current in the application, so the output voltage deviation is contained to 3% of the output voltage change. The minimum required output capacitance can be calculated as follows:

$$C_{OUT} = \frac{1}{2} \times \frac{I_{STEP} \times t_{RESPONSE}}{\Delta V_{OUT}}$$

$$t_{RESPONSE} \cong \left(\frac{0.33}{f_C} + \frac{1}{f_{SW}} \right)$$

where I_{STEP} is the load current step, $t_{RESPONSE}$ is the response time of the controller, ΔV_{OUT} is the allowable output-voltage deviation, f_C is the target closed-loop crossover frequency, and f_{SW} is the switching frequency. Select f_C to be 1/9th of f_{SW} if the switching frequency is less than or equal to 500kHz. If the switching frequency is more than 500kHz, select f_C to be 55kHz.

Soft-Start Capacitor Selection

The device implements adjustable soft-start operation to reduce inrush current. A capacitor connected from the SS pin to SGND programs the soft-start time. The selected output capacitance (C_{SEL}) and the output voltage (V_{OUT}) determine the minimum required soft-start capacitor as follows:

$$C_{SS} \geq 28 \times 10^{-6} \times C_{SEL} \times V_{OUT}$$

The soft-start time (t_{SS}) is related to the capacitor connected at SS (C_{SS}) by the following equation:

$$t_{SS} = \frac{C_{SS}}{5.55 \times 10^{-6}}$$

For example, to program a 1ms soft-start time, a 5.6nF capacitor should be connected from the SS pin to SGND.

Setting the Input Undervoltage-Lockout Level

The device offers an adjustable input undervoltage-lockout level. Set the voltage at which the device turns on with a resistive voltage-divider connected from V_{IN} to SGND. Connect the center node of the divider to EN/UVLO.

Choose R_1 to be 3.3M Ω and then calculate R_2 as follows:

$$R_2 = \frac{R_1 \times 1.215}{(V_{INU} - 1.215)}$$

where V_{INU} is the voltage at which the device is required to turn on. Ensure that V_{INU} is higher than $0.8 \times V_{OUT}$.

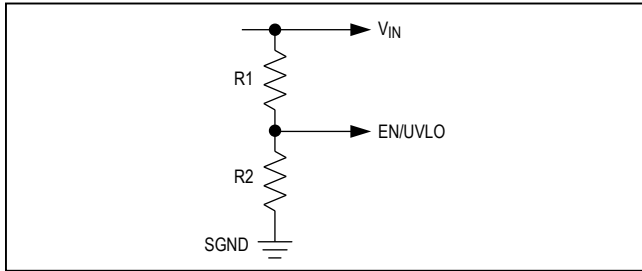

Figure 1. Setting the Input Undervoltage Lockout

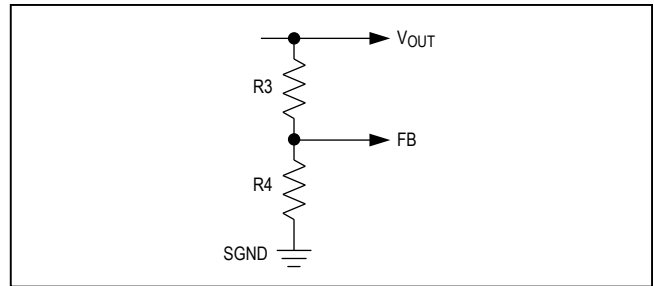

Figure 2. Setting the Output Voltage

Table 2. C6 Capacitor Value at Various Switching Frequencies

SWITCHING FREQUENCY RANGE (kHz)	C6 (pF)
200 to 300	2.2
300 to 400	1.2
400 to 500	0.75

Loop Compensation

The device is internally loop compensated. However, if the switching frequency is less than 500kHz, connect a 0402 capacitor C6 between the CF pin and the FB pin. Use [Table 2](#) to select the value of C6.

Adjusting Output Voltage

Set the output voltage with a resistive voltage-divider connected from the positive terminal of the output capacitor (V_{OUT}) to SGND (see Figure 2). Connect the center node of the divider to the FB pin. Use the following procedure to choose the resistive voltage-divider values:

Calculate resistor R3 from the output to the FB pin as follows:

$$R3 = \frac{216 \times 10^3}{f_C \times C_{OUT}}$$

where R3 is in kΩ, crossover frequency f_C is in kHz, and the output capacitor C_{OUT} is in μF. Choose f_C to be 1/9th of the switching frequency, f_{SW}, if the switching frequency is less than or equal to 500kHz. If the switching frequency is more than 500kHz, select f_C to be 55kHz.

Calculate resistor R4 from the FB pin to SGND as follows:

$$R4 = \frac{R3 \times 0.9}{(V_{OUT} - 0.9)}$$

Power Dissipation

Ensure that the junction temperature of the device does not exceed 125°C under the operating conditions specified for the power supply.

At a particular operating condition, the power losses that lead to temperature rise of the part are estimated as follows:

$$P_{LOSS} = (P_{OUT} \times (\frac{1}{\eta} - 1)) - (I_{OUT}^2 \times R_{DCR})$$

$$P_{OUT} = V_{OUT} \times I_{OUT}$$

where P_{OUT} is the total output power, η is the efficiency of the converter, and R_{DCR} is the DC resistances of the inductor. (See the [Typical Operating Characteristics](#) for more information on efficiency at typical operating conditions.)

For a multilayer board, the thermal performance metrics for the package are given below:

$$\theta_{JA} = 33^\circ\text{C/W}$$

$$\theta_{JC} = 2^\circ\text{C/W}$$

The junction temperature of the device can be estimated at any given maximum ambient temperature (T_{A_MAX}) from the equation below:

$$T_{J_MAX} = T_{A_MAX} + (\theta_{JA} \times P_{LOSS})$$

If the application has a thermal management system that ensures that the exposed pad of the device is maintained at a given temperature (T_{EP_MAX}) by using proper heat sinks, then the junction temperature of the device can be estimated at any given maximum ambient temperature from the equation below:

$$T_{J_MAX} = T_{EP_MAX} + (\theta_{JC} \times P_{LOSS})$$

PCB Layout Guidelines

All connections carrying pulsed currents must be very short and as wide as possible. The inductance of these connections must be kept to an absolute minimum due to the high di/dt of the currents. Since inductance of a current carrying loop is proportional to the area enclosed by the loop, if the loop area is made very small, inductance is reduced. Additionally, small-current loop areas reduce radiated EMI.

A ceramic input filter capacitor should be placed close to the V_{IN} pins of the IC. This eliminates as much trace inductance effects as possible and gives the IC a cleaner voltage supply. A bypass capacitor for the V_{CC} pin also should be placed close to the pin to reduce effects of trace impedance.

When routing the circuitry around the IC, the analog small-signal ground and the power ground for switching currents must be kept separate. They should be connected together at a point where switching activity is at a minimum, typically the return terminal of the V_{CC} bypass capacitor. This helps keep the analog ground quiet. The ground plane should be kept continuous/unbroken as far as possible. No trace carrying high switching current should be placed directly over any ground plane discontinuity.

PCB layout also affects the thermal performance of the design. A number of thermal vias that connect to a large ground plane should be provided under the exposed pad of the part, for efficient heat dissipation.

For a sample layout that ensures first pass success, refer to the MAX17505 evaluation kit layout available at www.maximintegrated.com.

Typical Application Circuit

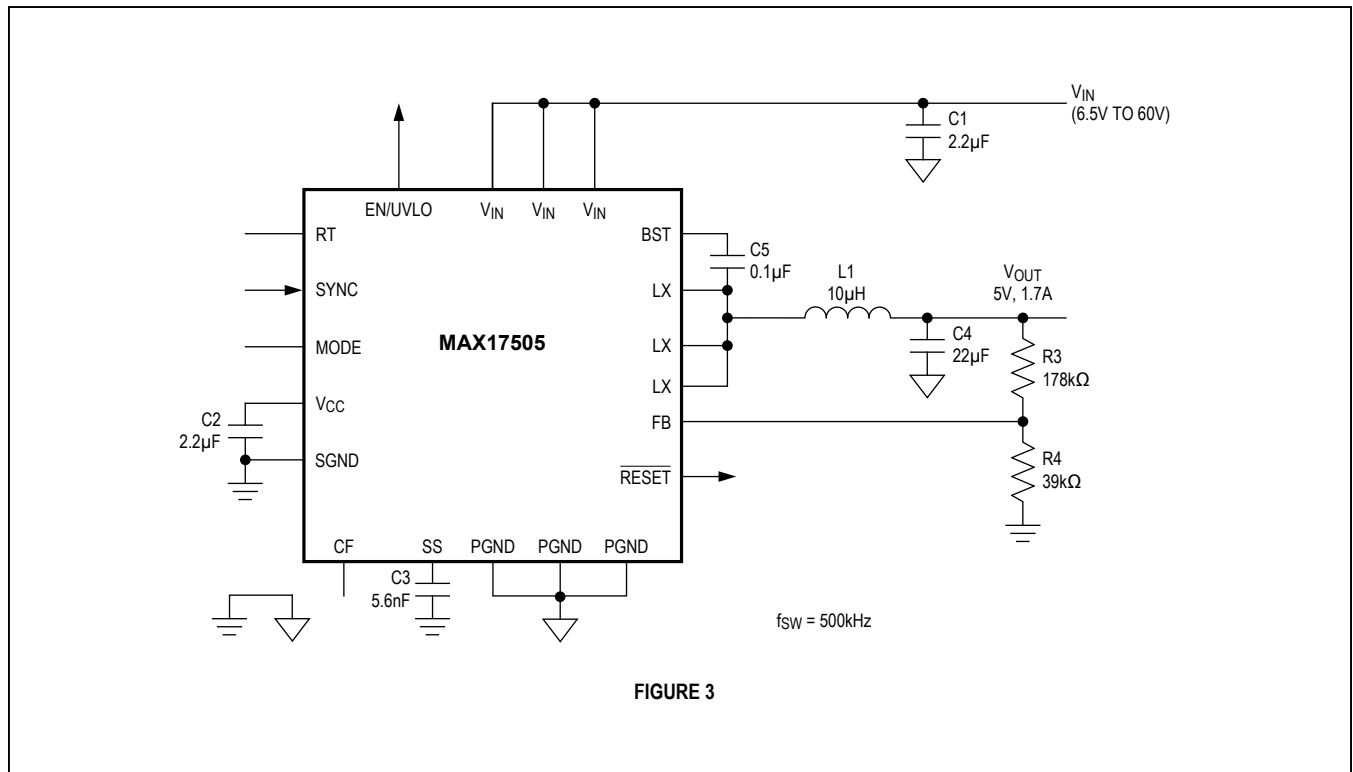

Typical Application Circuit (continued)

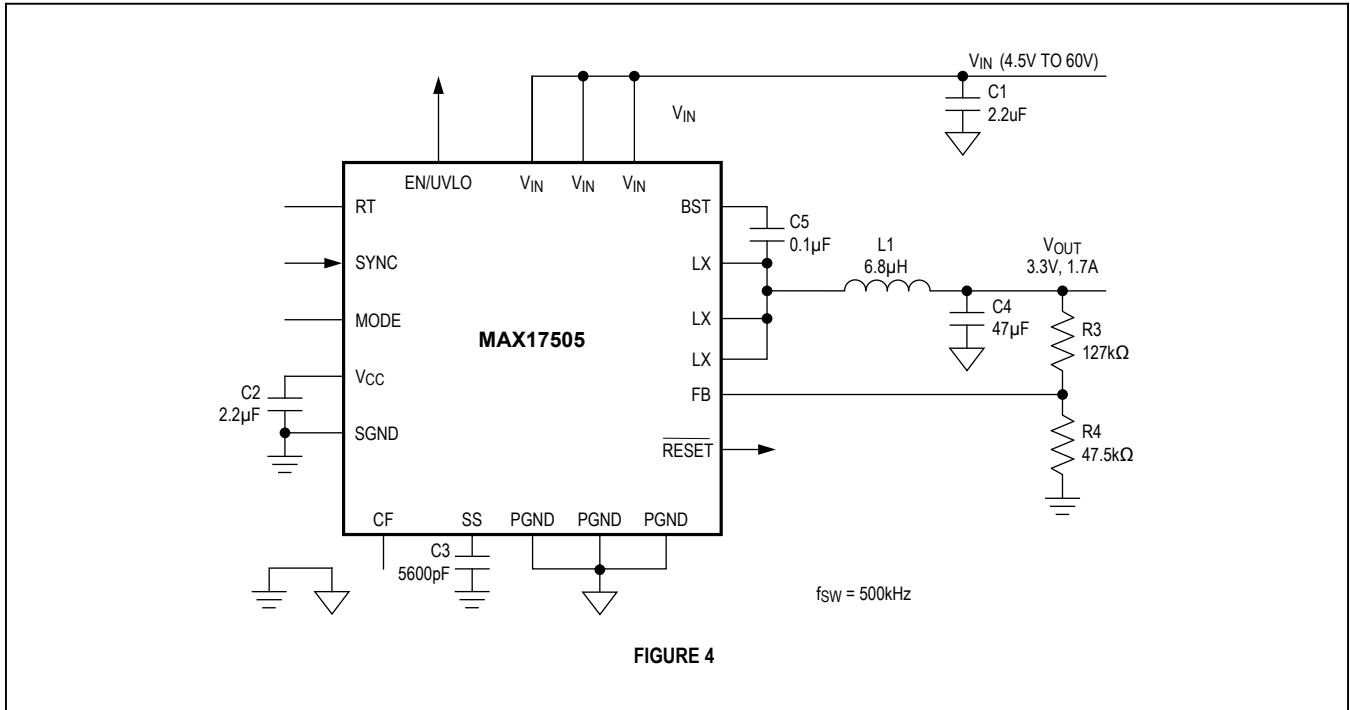

Ordering Information

PART	PIN-PACKAGE
MAX17505ATP+	20 TQFN (4mm x 4mm)

Note: Device operates over the -40°C to +125°C temperature range, unless otherwise noted.

+Denotes a lead(Pb)-free/RoHS-compliant package.
*EP = Exposed pad.

Chip Information

PROCESS: BiCMOS

Package Information

For the latest package outline information and land patterns (footprints), go to www.maximintegrated.com/packages. Note that a "+", "#", or "-" in the package code indicates RoHS status only. Package drawings may show a different suffix character, but the drawing pertains to the package regardless of RoHS status.

PACKAGE TYPE	PACKAGE CODE	OUTLINE NO.	LAND PATTERN NO.
20 TQFN-EP	T2044+4	21-0139	90-0409

MAX17505

4.5V-60V, 1.7A, High-Efficiency,
Synchronous Step-Down DC-DC Converter
With Internal Compensation

Revision History

REVISION NUMBER	REVISION DATE	DESCRIPTION	PAGES CHANGED
0	1/14	Initial release	—

For pricing, delivery, and ordering information, please contact Maxim Direct at 1-888-629-4642, or visit Maxim's website at www.maximintegrated.com.

Maxim cannot assume responsibility for use of any circuitry other than circuitry entirely embodied in a Maxim product. No circuit patent licenses are implied. Maxim reserves the right to change the circuitry and specifications without notice at any time. The parametric values (min and max limits) shown in the Electrical Characteristics table are guaranteed. Other parametric values quoted in this data sheet are provided for guidance.

Mouser Electronics

Authorized Distributor

Click to View Pricing, Inventory, Delivery & Lifecycle Information:

[Maxim Integrated:](#)

[MAX17505EVKITA#](#) [MAX17505EVKITB#](#) [MAX17505ATP+](#) [MAX17505ATP+T](#)