

MAX1757

General Description

The MAX1757 is a switch-mode lithium-ion (Li+) battery charger that charges one to three cells. It provides a regulated charging current accurate to $\pm 10\%$ and a regulated voltage with only a $\pm 0.8\%$ total voltage error at the battery terminals. The internal high-side switch delivers a programmable current of up to 1.5A to charge the battery. The built-in safety timer automatically terminates charging once the adjustable time limit has been reached.

The MAX1757 regulates the voltage set point and charging current using two loops that work together to transition smoothly between voltage and current regulation. An additional control loop monitors the total current drawn from the input source (charging + system) and by automatically reducing battery-charging current prevents overload of the input supply, allowing the use of a low-cost wall adapter.

The per-cell battery regulation voltage is set between 4.0V and 4.4V using standard 1% resistors. The number of cells is set from 1 to 3 by pin strapping. Battery temperature is monitored by an external thermistor to prevent charging outside the acceptable temperature range.

The MAX1757 is available in a space-saving 28-pin SSOP package. Use the MAX1757EVKIT to help reduce design time. For a stand-alone charger with a 28V switch, refer to the MAX1758 data sheet. For a charger controller capable of up to 4A charging current, refer to the MAX1737 data sheet.

Applications

Li+ Battery Packs PDAs
 Notebook Computers Desktop Cradle Chargers
 Hand-Held Instruments

Pin Configuration

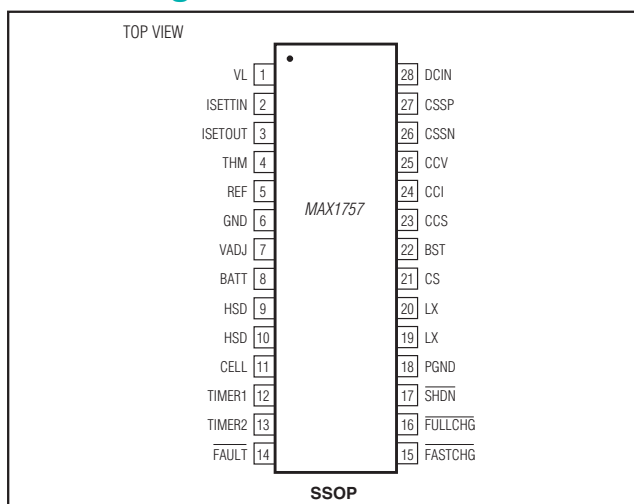

Stand-Alone, Switch-Mode Li+ Battery Charger with Internal 14V Switch

Benefits and Features

- Stand-Alone Charger Safely Charges Up to Three Li+ Batteries
 - Continuous Voltage and Temperature Monitoring
 - Input Current Limiting
 - $\pm 0.8\%$ Battery Regulation Voltage Accuracy
 - Up to 1.5A Programmable Charge Current
- Low Power Consumption Extends Battery Life
 - 0.1 μ A Shutdown Battery Current
 - Low-Dropout 98% Duty Cycle
- Flexible Input Voltage Range Enables the Use of Low Cost Wall Adapters
 - Input Voltage Up to 14V
 - Precharges Near-Dead Cells
- Fixed 300kHz PWM Oscillator Allows Effective Noise Filtering
- 28-Pin SSOP Package Saves Board Space

Ordering Information

PART	TEMP. RANGE	PIN-PACKAGE
MAX1757EAI	-40°C to +85°C	28 SSOP

Typical Operating Circuit

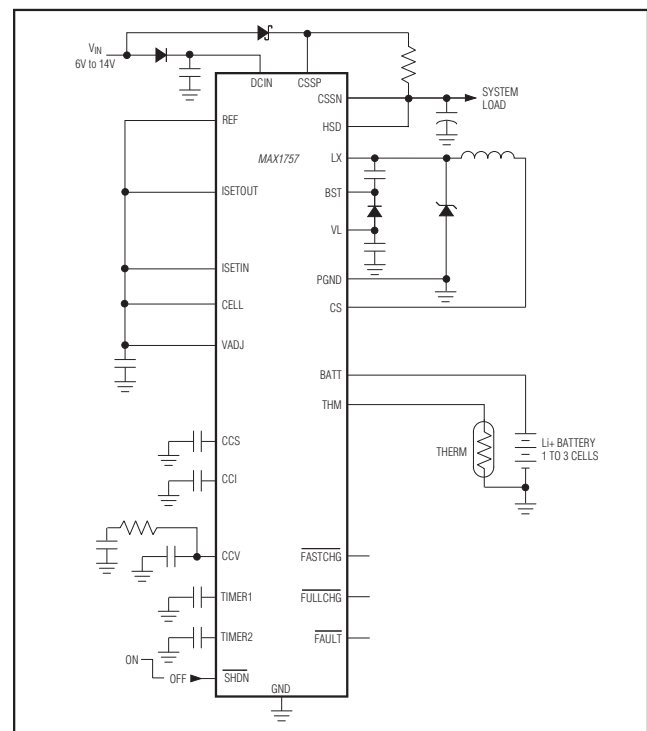

Absolute Maximum Ratings

BATT, CS, DCIN, CSSP, CSSN, HSD to GND-0.3V to +15V
 CSSP to CSSN-0.6V to +0.6V
 BST to GND-0.3V to +21V
 BST to LX-0.3V to +6V
 LX to PGND-0.6V to (V_{HSD} + 0.3V)
 VL, $\overline{\text{SHDN}}$, ISETIN, ISETOUT, REF, VADJ, CELL, TIMER1,
 TIMER2, CCI, CCS, CCV, THM to GND-0.3V to +6V
 FASTCHG, FULLCHG, FAULT to GND-0.3V to +30V
 CS to BATT Current±3.5A

PGND to GND-0.3V to +0.3V
 VL Source Current50mA
 Continuous Power Dissipation (T_A = +70°C)
 28-Pin SSOP (derate 9.5mW/°C above +70°C)762mW
 Operating Temperature Range-40°C to +85°C
 Junction Temperature+150°C
 Storage Temperature Range-65°C to +150°C
 Lead Temperature (soldering, 10s)+300°C

Stresses beyond those listed under "Absolute Maximum Ratings" may cause permanent damage to the device. These are stress ratings only, and functional operation of the device at these or any other conditions beyond those indicated in the operational sections of the specifications is not implied. Exposure to absolute maximum rating conditions for extended periods may affect device reliability.

Electrical Characteristics

(Circuit of Figure 1, V_{DCIN} = V_{HSD} = V_{CSSP} = V_{CSSN} = 12V, $\overline{\text{VSHDN}}$ = V_{VL}, V_{CELL} = GND, V_{BATT} = V_{CS} = 4.2V, V_{VADJ} = V_{REF}/2, V_{ISETIN} = V_{ISETOUT} = V_{REF}, R_{THM} = 10k Ω , T_A = 0°C to +85°C, unless otherwise noted. Typical values are at T_A = +25°C.)

PARAMETER	SYMBOL	CONDITIONS	MIN	TYP	MAX	UNITS
SUPPLY AND REFERENCE						
DCIN Input Voltage Range			6		14	V
DCIN Quiescent Supply Current		6V < V _{DCIN} < 14V		5	7	mA
DCIN to BATT Dropout Threshold, DCIN Falling		Falling edge	0.075	0.125	0.175	V
DCIN to BATT Dropout Threshold, DCIN Rising		Rising edge	0.20	0.30	0.40	V
VL Output Voltage		6V < V _{DCIN} < 14V	5.10	5.40	5.70	V
VL Output Load Regulation		I _{VL} = 0 to 15mA		44	65	mV
REF Output Voltage	V _{REF}	6V < V _{DCIN} < 14V	4.179	4.20	4.221	V
REF Line Regulation		6V < V _{DCIN} < 14V		2	6	mV
REF Load Regulation		I _{REF} = 0 to 1mA		6	14	mV
SWITCHING REGULATOR						
PWM Oscillator Frequency	f _{OSC}	Nondropout f _{OSC}	270	300	330	kHz
LX Maximum Duty Cycle		In dropout, f _{OSC} / 4	97	98		%
CSSN/CSSP Off-State Leakage		V _{CSSN} = V _{CSSP} = V _{DCIN} = 14V, $\overline{\text{VSHDN}}$ = GND		2	10	μ A
HSD Off-State Leakage		V _{LX} = PGND, V _{HSD} = V _{DCIN} = 14V, $\overline{\text{VSHDN}}$ = GND		0.1	10	μ A
LX Off-State Leakage		V _{LX} = V _{HSD} = V _{DCIN} = 14V, $\overline{\text{VSHDN}}$ = GND		0.1	10	μ A
HSD to LX On-Resistance		V _{BST} = V _{LX} + 4.5V		150	250	m Ω
LX to PGND On-Resistance		See <i>PWM Controller</i> section		1	2	Ω
CS to BATT Current-Sensing Resistance	R _{CS}	Internal resistor between CS and BATT, 1.5A RMS operating		110	170	m Ω
BATT, CS Input Current		$\overline{\text{VSHDN}}$ = GND, V _{BATT} = 14V		0.1	5	μ A
		CELL = REF, V _{BATT} = 12V, any charging state		280	540	μ A
		V _{BATT} = 14V, done state		150	270	μ A

Electrical Characteristics (continued)

(Circuit of Figure 1, $V_{DCIN} = V_{HSD} = V_{CSSP} = V_{CSSN} = 12V$, $V_{SHDN} = V_{VL}$, $V_{CELL} = GND$, $V_{BATT} = V_{CS} = 4.2V$, $V_{VADJ} = V_{REF}/2$, $V_{ISETIN} = V_{ISETOUT} = V_{REF}$, $R_{THM} = 10k\Omega$, $T_A = 0^{\circ}C$ to $+85^{\circ}C$, unless otherwise noted. Typical values are at $T_A = +25^{\circ}C$.)

PARAMETER	SYMBOL	CONDITIONS	MIN	TYP	MAX	UNITS
SWITCHING REGULATOR						
CS to BATT Hard Current Limit		Instantaneous peak current limit	2.4	2.7	3.0	A
BATT, CS Input Voltage Range			0		14	V
VOLTAGE LIMIT ACCURACY						
Battery Regulation Voltage	V_{BATTR}	CELL = float, GND, or REF	4.167	4.2	4.233	V/cell
Absolute Voltage Accuracy		Not including VADJ resistor tolerances	-0.8		0.8	%
		With 1% VADJ resistors	-1		1	
BATT Regulation Voltage Adjustment Range		VADJ = GND	3.948	3.979	4.010	V/cell
		VADJ = REF	4.386	4.421	4.453	
ERROR AMPLIFIERS						
CCV Amplifier Transconductance		$V_{CCV} = 2V$	0.4	0.7	1.0	mS × cells
CCV Amplifier Maximum Output Current		$V_{CCV} = 2V$	±50			μA
BATT Full-Scale Charge Current			1.35	1.5	1.65	A
BATT 1/10-Scale Charge Current (Note 1)		$V_{ISETOUT} = V_{REF}/10$	100	150	200	mA
BATT Charge Current in Prequalification State		$V_{BATT} < 2.4V$ per cell	100	150	200	mA
CCI Battery Current Sense Gain		$V_{CCI} = 2V$	60	130	240	μA/A
CCI Amplifier Maximum Output Current		$V_{CCI} = 2V$	±100			μA
CSSP to CSSN Full-Scale Current-Sense Voltage			90	100	115	mV
CSSP to CSSN 1/10-Scale Current-Sense Voltage		$V_{ISETIN} = V_{REF}/10$	5	10	15	mV
CCS Amplifier Transconductance		$V_{CCS} = 2V$	1.0	2.0	3.0	mS
CCS Amplifier Maximum Output Current		$V_{CCS} = 2V$	±100			μA
CCI, CCS Clamp Voltage with Respect to CCV			25		200	mV
CCV Clamp Voltage with Respect to CCI, CCS			25		200	mV
STATE MACHINE						
THM Trip Threshold Voltage	V_{TRT}	THM low-temp or high-temp current	1.386	1.40	1.414	V
THM Low-Temp Current	I_{TLTC}	$V_{THM} = 1.4V$	46.2	49	51.5	μA
THM High-Temp Current	I_{HTC}	$V_{THM} = 1.4V$	344	353	362	μA
THM COLD Threshold Resistance (Note 2)		Combines THM low-temp current and THM threshold, V_{TRT} / I_{TLTC}	26.92	28.70	30.59	kΩ
THM HOT Threshold Resistance (Note 2)		Combines THM high-temp current and THM threshold, V_{TRT} / I_{HTC}	3.819	3.964	4.115	kΩ

Electrical Characteristics (continued)

(Circuit of Figure 1, $V_{DCIN} = V_{HSD} = V_{CSP} = V_{SSN} = 12V$, $V_{SHDN} = V_{VL}$, $V_{CELL} = GND$, $V_{BATT} = V_{CS} = 4.2V$, $V_{VADJ} = V_{REF}/2$, $V_{ISETIN} = V_{ISETOUT} = V_{REF}$, $R_{THM} = 10k\Omega$, $T_A = 0^\circ C$ to $+85^\circ C$, unless otherwise noted. Typical values are at $T_A = +25^\circ C$.)

PARAMETER	SYMBOL	CONDITIONS	MIN	TYP	MAX	UNITS
STATE MACHINE						
BATT Undervoltage Threshold (Note 3)			2.4	2.5	2.6	V/cell
BATT Overvoltage Threshold (Note 4)			4.55	4.67	4.8	V/cell
FULLCHG BATT Current Termination Threshold (Note 5)			250	330	400	mA
BATT Recharge Voltage Threshold (Note 6)			94	95	96	% of $V_{BATTR} \times$ cells
TIMER1 and TIMER2 Oscillation Frequency			2.1	2.33	2.6	kHz
Prequalification Timer			6.25	7.5	8.75	min
Fast-Charge Timer			81	90	100	min
Full-Charge Timer			81	90	100	min
Top-Off Timer			40.5	45	49.8	min
Temperature Measurement Frequency			0.98	1.12	1.32	Hz
CONTROL INPUTS/OUTPUTS						
SHDN Input Voltage High	V_{IH}		1.4			V
SHDN Input Voltage Low	V_{IL}				0.6	V
VADJ, ISETIN, ISETOUT Input Voltage Range			0		V_{REF}	V
VADJ, ISETIN, ISETOUT Input Bias Current		$V_{VADJ}, V_{ISETIN}, V_{ISETOUT} = 0$ or $4.2V$	-50		50	nA
SHDN Input Bias Current		$V_{SHDN} = 0$ or V_{VL}	-1		1	μA
CELL Input Bias Current		$V_{CELL} = 0$ or V_{VL}	-5		5	μA
ISETOUT Shutdown Threshold Voltage (Note 3)			150	220	300	mV
CELL Input Voltage		For 1 cell	0		0.5	V
		For 2 cells (floating)	1.5		2.5	
		For 3 cells	$V_{REF} - 0.3$		$V_{REF} + 0.3$	

Electrical Characteristics (continued)

(Circuit of Figure 1, $V_{DCIN} = V_{HSD} = V_{CSSP} = V_{CSSN} = 12V$, $V_{SHDN} = V_{VL}$, $V_{CELL} = GND$, $V_{BATT} = V_{CS} = 4.2V$, $V_{VADJ} = V_{REF}/2$, $V_{ISETIN} = V_{ISETOUT} = V_{REF}$, $R_{THM} = 10k\Omega$, $T_A = 0^{\circ}C$ to $+85^{\circ}C$, unless otherwise noted. Typical values are at $T_A = +25^{\circ}C$.)

PARAMETER	SYMBOL	CONDITIONS	MIN	TYP	MAX	UNITS
CONTROL INPUTS/OUTPUTS						
$\overline{FASTCHG}$, $\overline{FULLCHG}$, \overline{FAULT} Output Low Voltage	V_{OL}	$I_{SINK} = 5mA$			0.5	V
$\overline{FASTCHG}$, $\overline{FULLCHG}$, \overline{FAULT} Output High Leakage		$V_{\overline{FASTCHG}}$, $V_{\overline{FULLCHG}}$, $V_{\overline{FAULT}} = 28V$, $V_{SHDN} = GND$			1	μA

Electrical Characteristics

(Circuit of Figure 1, $V_{DCIN} = V_{HSD} = V_{CSSP} = V_{CSSN} = 12V$, $V_{SHDN} = V_{VL}$, $V_{CELL} = GND$, $V_{BATT} = V_{CS} = 4.2V$, $V_{VADJ} = V_{REF}/2$, $V_{ISETIN} = V_{ISETOUT} = V_{REF}$, $R_{THM} = 10k\Omega$, $T_A = -40^{\circ}C$ to $+85^{\circ}C$, unless otherwise noted.) (Note 7)

PARAMETER	SYMBOL	CONDITIONS	MIN	TYP	MAX	UNITS
SUPPLY AND REFERENCE						
DCIN Input Voltage Range			6		14	V
VL Output Voltage			5.1		5.7	V
REF Output Voltage		$6V < V_{DCIN} < 14V$	4.166		4.242	V
REF Line Regulation		$6V < V_{DCIN} < 14V$			6	mV
SWITCHING REGULATOR						
PWM Oscillator Frequency	f_{OSC}	Nondropout f_{OSC}	260		340	kHz
HSD to LX On-Resistance		$V_{BST} = V_{LX} + 4.5V$			250	$m\Omega$
LX to PGND On-Resistance					2	Ω
CS to BATT Hard Current Limit		Instantaneous peak current limit	2.2		3.2	A
BATT, CS Input Voltage Range			0		14	V
ACCURACY AND ERROR AMPLIFIERS						
Absolute Voltage Accuracy		Not including VADJ resistor tolerances	-0.8		0.8	%
		With 1% VADJ resistors	-1		1	
BATT Regulation Voltage		CELL = float, GND, or REF	4.158		4.242	V/cell
BATT Full-Scale Charge Current			1.3		1.7	A
BATT 1/10-Scale Charge Current (Note 1)		$V_{ISETOUT} = V_{REF}/10$	100		200	mA
BATT Charge Current in Prequalification State		$V_{BATT} < 2.4V$ per cell	100		200	mA
CSSP to CSSN Full-Scale Current-Sense Voltage			85		115	mV
CSSP to CSSN 1/10-Scale Current-Sense Voltage		$V_{ISETIN} = V_{REF}/10$	5		15	mV
STATE MACHINE						
THM Trip Threshold Voltage	V_{TRT}	THM low-temp or high-temp current	1.386		1.414	V
THM Low-Temp Current	I_{TLTC}	$V_{THM} = 1.4V$	46.2		51.5	μA
BATT Undervoltage Threshold (Note 3)			2.4		2.6	V/cell
BATT Overvoltage Threshold (Note 4)			4.55		4.8	V/cell

Electrical Characteristics (continued)

(Circuit of Figure 1, $V_{DCIN} = V_{HSD} = V_{CSP} = V_{CSSN} = 12V$, $V_{\overline{SHDN}} = V_{VL}$, $V_{CELL} = GND$, $V_{BATT} = V_{CS} = 4.2V$, $V_{VADJ} = V_{REF}/2$, $V_{ISETIN} = V_{ISETOUT} = V_{REF}$, $R_{THM} = 10k\Omega$, $T_A = -40^{\circ}C$ to $+85^{\circ}C$, unless otherwise noted.) (Note 7)

PARAMETER	SYMBOL	CONDITIONS	MIN	TYP	MAX	UNITS
$\overline{FULLCHG}$ BATT Current Termination Threshold (Note 5)			250		400	mA
Temperature Measurement Frequency			0.93		1.37	Hz
CONTROL INPUTS/OUTPUTS						
\overline{SHDN} Input Voltage High	V_{IH}		1.4			V
\overline{SHDN} Input Voltage Low	V_{IL}				0.6	V

Note 1: When $V_{ISETOUT} = 0$, battery charger turns off.

Note 2: See *Thermistor* section.

Note 3: Below this threshold, charger reverts to a prequalification mode with I_{BATT} reduced to 10% of full scale.

Note 4: Above this threshold, charger is disabled.

Note 5: After full-charge state is complete and BATT current falls below this threshold, $\overline{FULLCHG}$ output switches high. Battery charging continues until top-off timeout occurs. See Table 1.

Note 6: After charging is complete, when BATT voltage falls below this threshold, a new charging cycle is initiated.

Note 7: Specifications to $-40^{\circ}C$ are guaranteed by design, not production tested.

Typical Operating Characteristics

(Circuit of Figure 1, $V_{DCIN} = 12V$, $V_{SHDN} = V_{VL}$, $V_{CELL} = GND$, $V_{VADJ} = V_{REF}/2$, $V_{ISETIN} = V_{ISETOUT} = V_{REF}$, see Figure 1, $T_A = +25^\circ C$ unless otherwise noted.)

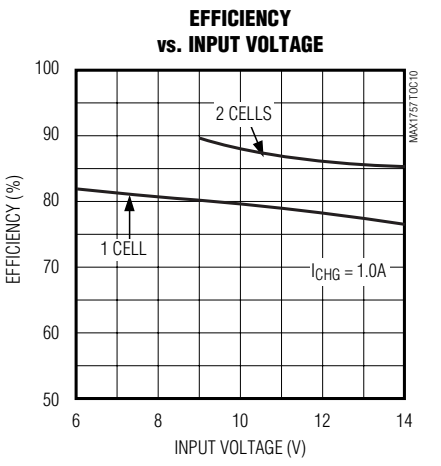
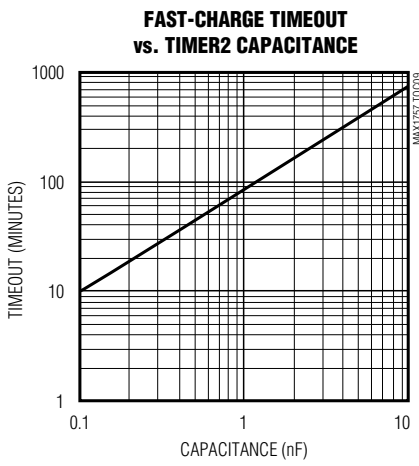
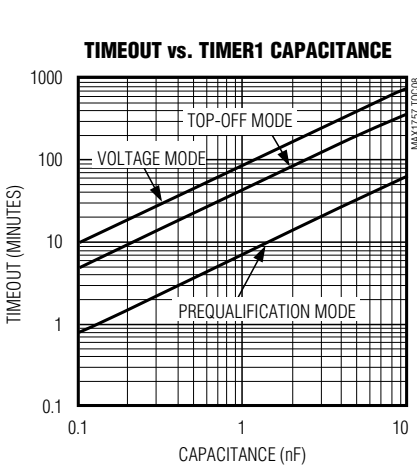
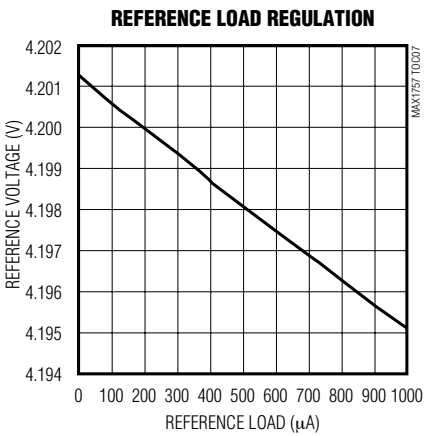
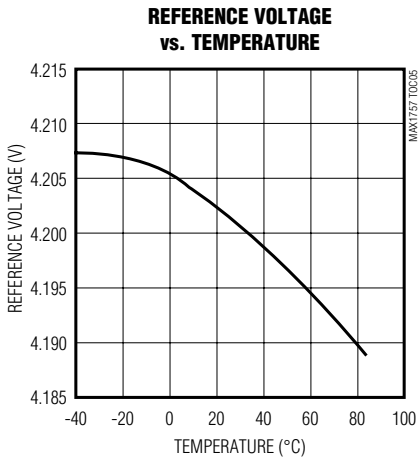
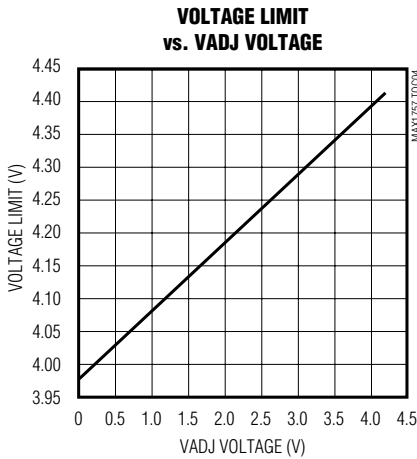
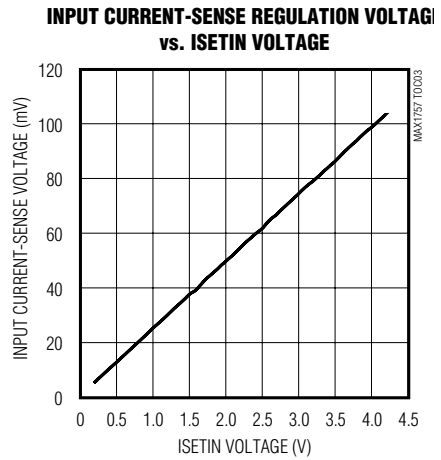
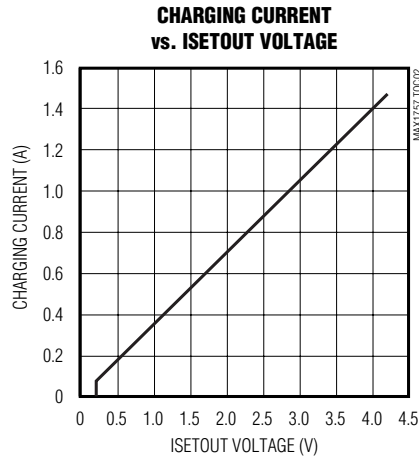
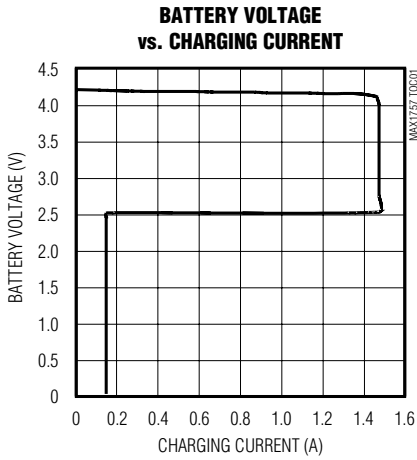

Pin Description

PIN	NAME	FUNCTION
1	VL	Chip Power Supply. Output of the 5.4V linear regulator from DCIN. Bypass VL to GND with 2.2 μ F or larger ceramic capacitor.
2	ISETIN	Input Current Limit Adjust. Use a voltage divider to set the voltage between 0 and VREF. See <i>Input Current Regulator</i> section.
3	ISETOUT	Battery Charging Current Adjust. Use a voltage divider to set the voltage between 0 and VREF. See <i>Charging Current Regulator</i> section.
4	THM	Thermistor Input. Connect a thermistor from THM to GND to set qualification temperature range. If unused, connect a 10k Ω resistor from THM to GND. See <i>Thermistor</i> section.
5	REF	4.2V Reference Voltage Output. Bypass REF to GND with 1 μ F or larger ceramic capacitor.
6	GND	Analog Ground
7	VADJ	Voltage Adjustment. Use a voltage divider to set the voltage between 0 and VREF to adjust the battery regulation voltage by \pm 5%. See <i>Battery Regulation Voltage</i> section.
8	BATT	Battery Voltage-Sense Input and Current-Sense Negative Input
9, 10	HSD	High-Side Drain. This is the drain of the internal high-side FET. See Figure 3.
11	CELL	Cell-Count Programming Input. Connect CELL to GND or REF to set 1 or 3 cells, or leave unconnected to set 2 cells.
12	TIMER1	Timer1 Adjustment. Connect a capacitor from TIMER1 to GND to set the prequalification, full-charge, and top-off times. See <i>Timers</i> section.
13	TIMER2	Timer2 Adjustment. Connect a capacitor from TIMER2 to GND to set the fast-charge time. See <i>Timers</i> section.
14	FAULT	Charge Fault Indicator. Open-drain output pulls low when charging terminates abnormally. See Table 1.
15	FASTCHG	Fast-Charge Indicator. Open-drain output pulls low when charging with constant current.
16	FULLCHG	Full-Charge Indicator. Open drain output pulls low when charging with constant voltage in full-charge state.
17	SHDN	Shutdown Input. Drive SHDN low to disable charging. Connect SHDN to VL for normal operation.
18	PGND	Power Ground. Current from the low-side power MOSFET switch source flows through PGND.
19, 20	LX	Power Inductor Switching Node and High-Side Power MOSFET Source
21	CS	Battery Current-Sense Positive Input. Connects to internal 0.1 Ω resistor between BATT and CS.
22	BST	High-Side MOSFET Gate Drive Bias. Connect a 0.1 μ F capacitor from BST to LX.
23	CCS	Charger Source Current Regulation Loop Compensation Point. See <i>Compensation</i> section.
24	CCI	Battery Charge Current Regulation Loop Compensation Point. See <i>Compensation</i> section.
25	CCV	Voltage Regulation Loop Compensation Point. See <i>Compensation</i> section.
26	CSSN	Source Current-Sense Negative Input. See <i>Input Current Regulator</i> section.
27	CSSP	Source Current-Sense Positive Input. See <i>Input Current Regulator</i> section.
28	DCIN	Power-Supply Input. DCIN is the input supply for the VL regulator. Bypass DCIN to GND with a 0.1 μ F or greater capacitor. See <i>Detailed Description</i> .

Table 1. Charging State Table

STATE	ENTRY CONDITIONS	STATE CONDITIONS
Reset	From initial power on or From done state if battery voltage < recharge voltage threshold or $V_{DCIN} - V_{BATT} < \text{dropout threshold}$ or $V_{BATT} > \text{battery overvoltage threshold}$	Timers reset, charging current = 0, $\overline{\text{FASTCHG}} = \text{high}$, $\overline{\text{FULLCHG}} = \text{high}$, $\overline{\text{FAULT}} = \text{high}$
Prequalification	From reset state if input power, reference, and internal bias are within limits	Battery voltage \leq undervoltage threshold, charging current = (fast-charge current / 10), timeout = 7.5min typ ($C_{\text{TIMER1}} = 1\text{nF}$), $\overline{\text{FASTCHG}} = \text{low}$, $\overline{\text{FULLCHG}} = \text{high}$, $\overline{\text{FAULT}} = \text{high}$
Fast Charge (Constant Current)	From prequalification state if battery voltage > undervoltage threshold	Undervoltage threshold \leq battery voltage \leq battery regulation voltage, charging current = charge current limit, timeout = 90min typ ($C_{\text{TIMER2}} = 1\text{nF}$), $\overline{\text{FASTCHG}} = \text{low}$, $\overline{\text{FULLCHG}} = \text{high}$, $\overline{\text{FAULT}} = \text{high}$
Full Charge (Constant Voltage)	From fast-charge state if battery voltage = battery regulation voltage	Battery voltage = battery regulation voltage, charging current $\leq 330\text{mA}$, timeout = 90min typ ($C_{\text{TIMER1}} = 1\text{nF}$), $\overline{\text{FASTCHG}} = \text{high}$, $\overline{\text{FULLCHG}} = \text{low}$, $\overline{\text{FAULT}} = \text{high}$
Top-Off (Constant Voltage)	From full-charge state if full-charge timer expires or If charging current $\leq 330\text{mA}$	Battery voltage = battery regulation voltage, charging current $\leq 330\text{mA}$ timeout = 45min typ ($C_{\text{TIMER1}} = 1\text{nF}$), $\overline{\text{FASTCHG}} = \text{high}$, $\overline{\text{FULLCHG}} = \text{high}$, $\overline{\text{FAULT}} = \text{high}$
Done	From top-off state if top-off timer expires	Recharge voltage threshold \leq battery, voltage \leq voltage limit, charging current = 0, $\overline{\text{FASTCHG}} = \text{high}$, $\overline{\text{FULLCHG}} = \text{high}$, $\overline{\text{FAULT}} = \text{high}$
Over/Undertemperature	From fast-charge state or full-charge state if battery temperature is outside limits	Charge current = 0, timers suspended, $\overline{\text{FASTCHG}} = \text{no change}$, $\overline{\text{FULLCHG}} = \text{no change}$, $\overline{\text{FAULT}} = \text{no change}$
Fault	From reset state if battery temperature \geq maximum battery temperature or From prequalification state if prequalification timer expires or From fast-charge state if fast-charge timer expires	Charging current = 0, $\overline{\text{FASTCHG}} = \text{high}$, $\overline{\text{FULLCHG}} = \text{high}$, $\overline{\text{FAULT}} = \text{low}$

The MAX1757 includes a state machine that controls the charging algorithm. Figure 4 shows the state diagram. Table 1 is the charging state table. When power is applied, or $\overline{\text{SHDN}}$ input is driven high, the part goes into the reset state where the timers are reset to zero to prepare for charging. From the reset state, it enters the prequalification state. In this state, 1/10 of the fast-charge current charges the battery, and the battery temperature and voltage are measured. If the voltage is above the undervoltage threshold and the temperature is within the limits, then it will enter the fast-charge state. If the battery voltage does not rise above the undervoltage threshold before the prequalification timer expires, the charging terminates and the $\overline{\text{FAULT}}$ output goes low. The prequalification time is set by the TIMER1 capacitor (CTIMER1). If the battery is outside the temperature limits, charging and the timer are suspended. Once the temperature is back within limits, charging and the timer resume.

In the fast-charge state, the $\overline{\text{FASTCHG}}$ output goes low and the batteries charge with a constant current (see *Charging Current Regulator* section). If the battery voltage reaches the voltage limit before the fast timer expires, the part enters the full-charge state. If the fast-charge timer expires before the voltage limit is reached, charging terminates and the $\overline{\text{FAULT}}$ output goes low. The fast-charge time limit is set by the TIMER2 capacitor (CTIMER2). If the battery temperature is outside the limits, charging pauses and the timers are suspended until the temperature returns to within the limits.

In the full-charge state, the $\overline{\text{FULLCHG}}$ output goes low and the batteries charge at a constant voltage (see *Voltage* section). When the charging current drops below 150mA (330mA peak inductor current), or if the full-charge timer expires, the state machine enters the top-off state. In the top-off state, the batteries continue to charge at a constant voltage until the top-off timer expires, at which time it enters the done state. In the done state, charging stops until the battery voltage drops below the recharge-voltage threshold, at which time it enters the reset state to start the charging process again. In the full-charge or the top-off state, if the battery temperature is outside the limits, charging pauses and the timers are suspended until the battery temperature returns to within limits.

Voltage Regulator

Li+ batteries require a high-accuracy voltage limit while charging. The MAX1757 uses a high-accuracy voltage regulator ($\pm 0.8\%$) to limit the charging voltage. The battery regulation voltage is nominally set to 4.2V per cell and can be adjusted $\pm 5\%$ by changing the voltage at

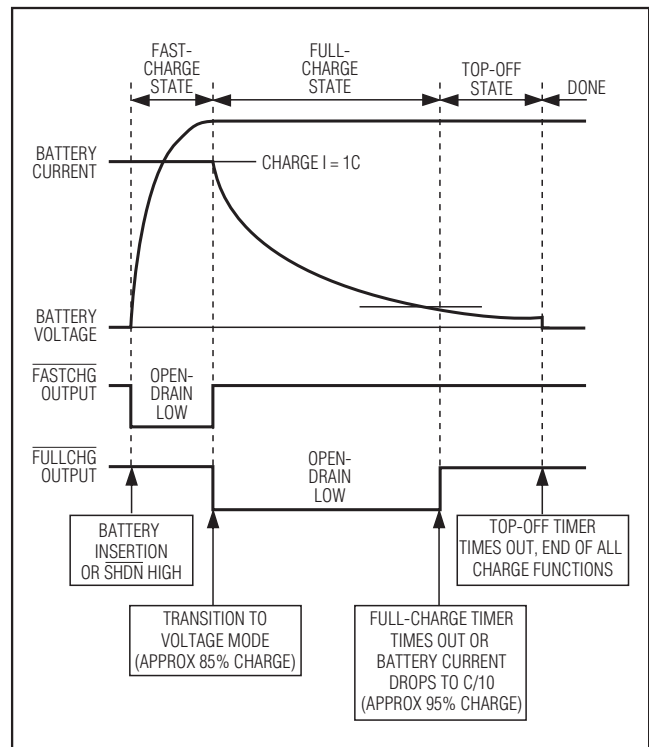

Figure 2. Charge State and Indicator Output Timing for a Typical Charging Sequence

the VADJ pin between reference voltage and ground. By limiting the adjust range of the regulation voltage, an overall voltage accuracy of better than 1% is maintained while using 1% resistors. CELL sets the cell count from 1 to 3 series cells (see *Setting the Battery Regulation Voltage* section).

An internal error amplifier (GMV) maintains voltage regulation (Figure 3). The GMV amplifier is compensated at CCV . The component values shown in Figure 1 provide suitable performance for most applications. Individual compensation of the voltage regulation and current regulation loops allows for optimum stability.

Charging Current Regulator

The charging current-limit regulator limits the charging current. Current is sensed by measuring the voltage across the internal current-sense resistor R_{CS} between BATT and CS . The voltage at ISETOUT adjusts the charging current. Full-scale charging current is achieved when ISETOUT is connected to REF .

The charging current error amplifier (GMI) is compensated at CCI . A 0.1 μF capacitor at CCI provides suitable performance for most applications.

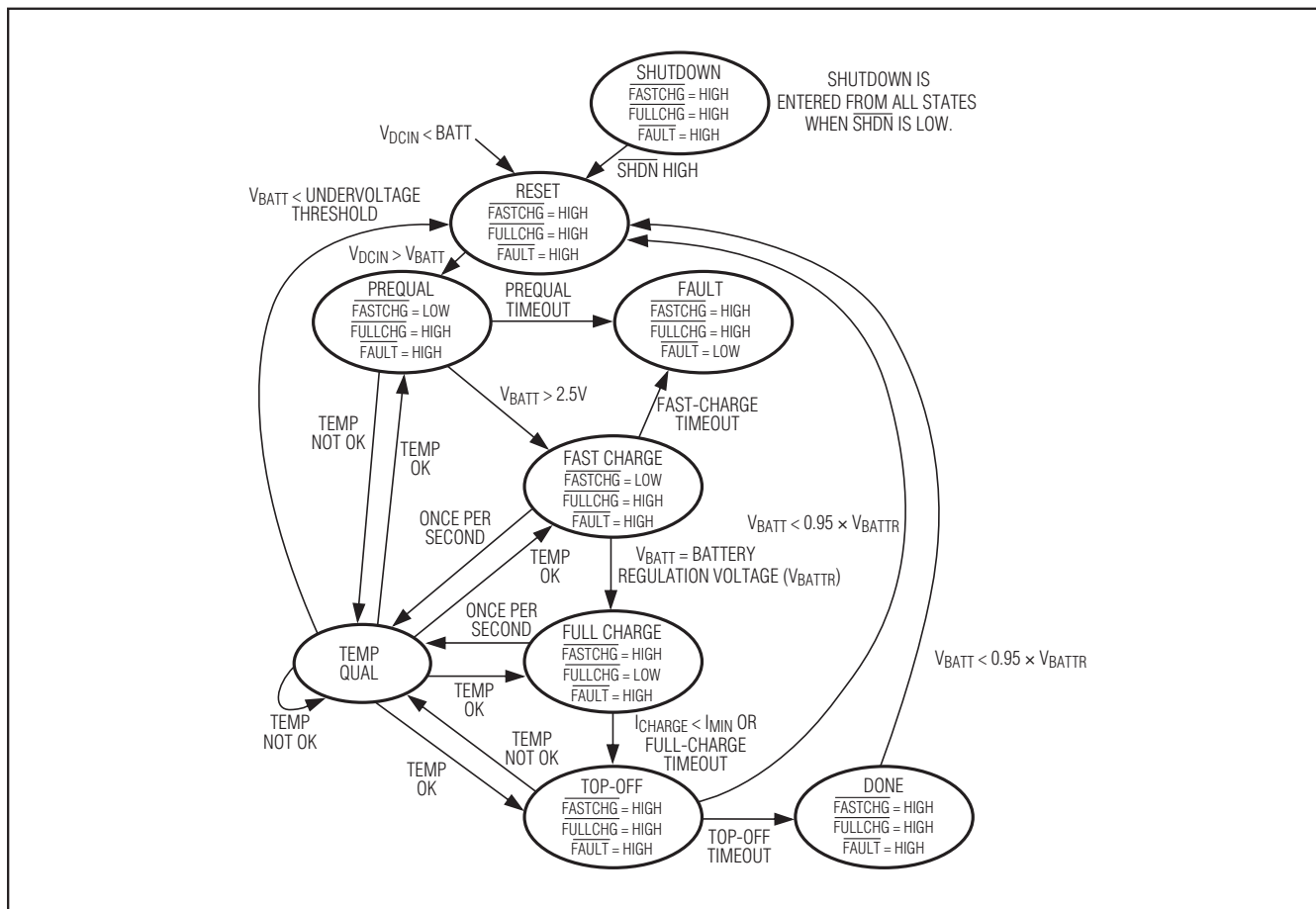

Figure 4. State Diagram

When choosing the current-sense resistor, note that the voltage drop across this resistor adds to the power loss, reducing efficiency. Reducing the voltage across the current-sense resistor may degrade input current limit accuracy due to the input offset of the input current-sense amplifier.

The input current error amplifier (GMS) is compensated at CCS. A 0.1µF capacitor at CCS provides suitable performance for most applications.

PWM Controller

The PWM controller drives the internal high-side MOSFET to control charging current or voltage. The input to the PWM controller is the lowest of CCI, CCV, or CCS. An internal clamp limits the noncontrolling signals to within 200mV of the controlling signal to prevent delay when switching between regulation loops.

The current mode PWM controller measures the inductor current to regulate the output voltage or current, simplifying stabilization of the regulation loops. Separate compensation of the regulation circuits allows each to be optimally stabilized. Internal slope compensation is included, ensuring stable operation over a wide range of duty cycles.

The controller drives an internal N-channel MOSFET switch to step the input voltage down to the battery voltage. The high-side MOSFET gate is driven to a voltage higher than the input source voltage by a bootstrap capacitor. This capacitor (between BST and LX) is charged through a diode from VL when LX is low. An internal N-channel MOSFET turns on momentarily after the high-side switch turns off, pulling LX to PGND to ensure that the bootstrap capacitor charges. The high-side MOSFET gate is driven from BST, supplying suffi-

cient voltage to fully drive the MOSFET gate even when its source is near the input voltage.

Timers

The MAX1757 includes safety timers to terminate charging and to ensure that faulty batteries are not charged indefinitely. TIMER1 and TIMER2 set the time-out periods.

TIMER1 controls the maximum prequalification time, maximum full-charge time, and the top-off time. TIMER2 controls the maximum fast-charge time. The timers are set by external capacitors. The typical times of 7.5 minutes for prequalification, 90 minutes for full charge, 45 minutes for top-off, and 90 minutes for fast charge are set by using a 1nF capacitor on TIMER1 and TIMER2 (Figure 1).

Charge Monitoring Outputs

FASTCHG, FULLCHG, and FAULT are open-drain outputs that can be used as LED drivers. $\overline{\text{FASTCHG}}$ indicates the battery is being fast charged. $\overline{\text{FULLCHG}}$ indicates the charger has completed the fast-charge cycle (approximately 85% charge) and is operating in voltage mode. The FASTCHG and FULLCHG outputs can be tied together to indicate charging or done (Figure 2). $\overline{\text{FAULT}}$ indicates the charger has detected a charging fault and that charging has terminated. The charger can be brought out of the FAULT condition only by removing and reapplying the input power, or by pulling $\overline{\text{SHDN}}$ low.

Thermistor

The intent of THM is to inhibit charging when the battery is too cold or too hot ($+2.5^{\circ}\text{C} \leq T_{\text{OK}} \leq +47.5^{\circ}\text{C}$), using an external thermistor. THM time multiplexes two sense currents to test for both hot and cold qualification. The thermistor should be $10\text{k}\Omega$ at $+25^{\circ}\text{C}$ and have a negative temperature coefficient (NTC); the THM pin expects $3.97\text{k}\Omega$ at $+47.5^{\circ}\text{C}$ and $28.7\text{k}\Omega$ at $+2.5^{\circ}\text{C}$. Connect the thermistor between THM and GND. If no temperature qualification is desired, replace the thermistor with a $10\text{k}\Omega$ resistor. Thermistors by Philips/BCcomponents (2322-640-63103), Cornerstone Sensors (T101D103-CA), and Fenwall Electronics (140-103LAG-RB1) work well. The battery temperature is measured at a 1.12Hz rate ($\text{CTIMER1} = \text{CTIMER2} = 1\text{nF}$). Charging is briefly halted to allow accurate measurement.

If the temperature goes out of limits while charging is in progress, charging will be suspended until the temperature returns to within the limits. While charging is suspended, the timers will also be suspended but will

Table 2. Cell-Count Programming Table

CELL	CELL COUNT (N)
GND	1
Float	2
REF	3

continue counting from where they left off when charging resumes.

Shutdown

When $\overline{\text{SHDN}}$ is pulled low, the MAX1757 enters the shutdown mode and charging is stopped. In shutdown, the internal resistive voltage divider is removed from BATT to reduce the current drain on the battery to less than $5\mu\text{A}$. The high-side power MOSFET switch is off. However, the internal linear regulator (VLO) and the reference (REF) remain on. Status outputs $\overline{\text{FASTCHG}}$, $\overline{\text{FULLCHG}}$, and $\overline{\text{FAULT}}$ are high impedance. When exiting the shutdown mode, the MAX1757 goes to the power-on reset state, which resets the timers and begins a new charge cycle.

Source Undervoltage Shutdown (Dropout)

If the voltage on DCIN drops within 100mV of the voltage on BATT, the charger turns off. This prevents battery discharge by the charger during low input voltage conditions.

Design Procedure

Setting the Battery Regulation Voltage

VADJ sets the per-cell voltage limit. To set the VADJ voltage, use a voltage-divider from REF to VADJ. A GND-to-VREF change at VADJ results in a $\pm 5\%$ change in the battery limit voltage. Since the full VADJ range results in only a 10% change on the battery regulation voltage, the resistor-divider's accuracy need not be as high as the output-voltage accuracy. Using 1% resistors for the voltage dividers results in no more than 0.1% degradation in output-voltage accuracy. VADJ is internally buffered so that high-value resistors can be used. Set VVADJ by choosing a value less than $100\text{k}\Omega$ for R5 (Figure 1) from VADJ to GND. The per-cell battery termination voltage is a function of the battery chemistry and construction; thus, consult the battery manufacturer to determine this voltage. Once the per-cell voltage limit battery regulation voltage is determined, the VADJ voltage is calculated by the equation:

$$V_{\text{VADJ}} = (9.5 V_{\text{BATTR}} / N) - (9.0 \times V_{\text{REF}})$$

CELL is the programming input for selecting cell count N. Table 2 shows how CELL is connected to charge 1, 2, or 3 cells.

Setting the Charging Current Limit

A resistor-divider from REF to GND sets the voltage at ISETOUT (V_{ISETOUT}). This determines the charging current during the current-regulation (fast-charge) mode. The full-scale charging current is 1.5A.

The charging current (I_{CHG}) is, therefore:

$$I_{CHG} = 1.5A \left(\frac{V_{ISETOUT}}{V_{REF}} \right)$$

Connect ISETOUT to REF to get the full-scale current limit.

Setting the Input Current Limit

A resistor-divider from REF to GND sets the voltage at ISETIN (V_{ISETIN}). This sets the maximum source current allowed at any time during charging. The source current I_{FSS} is set by the current-sense resistor R_{SOURCE} between C_{SSP} and C_{SSN}. The full-scale source current is I_{FSS} = 0.1V / R₁ (Figure 1).

The input current limit (I_{IN}) is therefore:

$$I_{IN} = I_{FSS} \left(\frac{V_{ISETIN}}{V_{REF}} \right)$$

Connect ISETIN to REF to get the full-scale input current limit. Short C_{SSP} and C_{SSN} if the input source current limit is not used.

In choosing the current-sense resistor, it should be noted that the drop across this resistor adds to the power loss and thus reduces efficiency. However, too low a resistor value may degrade input current-limit accuracy.

Inductor Selection

The inductor value may be changed for more or less ripple current. The higher the inductance, the lower the ripple current will be; however, as the physical size is kept the same, typically, higher inductance will result in higher series resistance and lower saturation current. A good tradeoff is to choose the inductor so that the ripple current is approximately 30% to 50% of the DC average charging current. The ratio of ripple current to DC charging current (LIR) can be used to calculate the optimal inductor value:

$$L = \frac{V_{BATT}(V_{DCIN(MAX)} - V_{BATT})}{V_{DCIN(MAX)} \times f_{OSC} \times I_{CHG} \times LIR}$$

where f_{OSC} is the switching frequency (300kHz).

The peak inductor current is given by:

$$I_{PEAK} = I_{ISETOUT} \left(1 + \frac{LIR}{2} \right)$$

Capacitor Selection

The input capacitor shunts the switching current from the charger input and prevents that current from circulating through the source, typically an AC wall cube. Thus, the input capacitor must be able to handle the input RMS current. Typically, at high charging currents, the converter will operate in continuous conduction (the inductor current does not go to 0). In this case, the RMS current of the input capacitor may be approximated by the equation:

$$I_{CIN} \cong I_{CHG} \sqrt{D - D^2}$$

where:

I_{CIN} is the input capacitor RMS current.

D is the PWM converter duty ratio (typically V_{BATT} / V_{DCIN}).

I_{CHG} is the battery charging current.

The maximum RMS input current occurs at 50% duty cycle; thus, the worst-case input ripple current is 0.5 × I_{CHG}. If the input-to-output voltage ratio is such that the PWM controller will never work at 50% duty cycle, then the worst-case capacitor current will occur where the duty cycle is nearest 50%.

The input capacitor impedance is critical to preventing AC currents from flowing back into the wall cube. This requirement varies depending on the wall cube impedance and the requirements of any conducted or radiated EMI specifications that must be met. Aluminum electrolytic capacitors are generally the cheapest, but usually are a poor choice for portable devices due to their large size and poor equivalent series resistance (ESR). Tantalum capacitors are better in most cases, as are high-value ceramic capacitors. For equivalent size and voltage rating, tantalum capacitors will have higher capacitance, but also higher ESR than ceramic capacitors. This makes it more critical to consider RMS current and power dissipation ratings when using tantalum capacitors.

The output filter capacitor is used to absorb the inductor ripple current. The output capacitor impedance must be significantly less than that of the battery to ensure that it will absorb the ripple current. Both the

capacitance and ESR rating of the capacitor are important for its effectiveness as a filter and to ensure stability of the PWM circuit. The minimum output capacitance for stability is:

$$C_{OUT} > \frac{V_{REF} \left(1 + \frac{V_{BATT}}{V_{DCIN(MIN)}} \right)}{V_{BATT} \times f_{OSC} \times R_{CS}}$$

where:

C_{OUT} is the total output capacitance.

V_{REF} is the reference voltage (4.2V).

V_{BATT} is the maximum battery regulation voltage (typically 4.2V per cell).

$V_{DCIN(MIN)}$ is the minimum source input voltage.

The maximum output capacitor ESR required for stability is:

$$R_{ESR} < \frac{R_{CS} \times V_{BATT}}{V_{REF}}$$

where:

R_{ESR} is the output capacitor ESR.

R_{CS} is the current-sense resistor from CS to BATT (100m Ω typ).

Setting the Timers

The MAX1757 contains four timers: a prequalification timer, fast-charge timer, full-charge timer, and top-off timer. Connecting a capacitor from TIMER1 to GND and TIMER2 to GND sets the timer periods. The TIMER1 input controls the prequalification, full-charge, and top-off times while TIMER2 controls the fast-charge timeout. The typical timeouts for a 1C charge rate are set to 7.5 minutes for the prequalification timer, 90 minutes for the fast-charge timer, 90 minutes for the full-charge timer, and 45 minutes for the top-off timer by connecting 1nF capacitors to TIMER1 and TIMER2. Each timer period is directly proportional to the capacitance at the corresponding pin (see *Typical Operating Characteristics*).

Compensation

Each of the three regulation loops—the input current limit, the charging current limit, and the charging voltage limit—can be compensated separately at the CCS, CCI, and CCV pins, respectively.

The charge-current loop error amp output is brought out at CCI. Likewise, the source-current error amplifier output is brought out at CCS; 0.1 μ F capacitors to ground at CCI and CCS compensate the current loops in most charger designs. Raising the value of these capacitors reduces the bandwidth of these loops.

The voltage-regulating loop error amp output is brought out at CCV. Compensate this loop by connecting a capacitor in parallel with a series resistor-capacitor (RC) from CCV to GND. Recommended values are shown in Figure 1.

Applications Information

Diode Selection

A Schottky rectifier with a rating of at least 1.5A must be connected from LX to PGND.

VL and REF Bypassing

The MAX1757 uses an internal linear regulator to drop the input voltage down to 5.4V, which powers the internal circuitry. The output of the linear regulator is the VL pin. The internal linear regulator may also be used to power external circuitry as long as the maximum current of the linear regulator is not exceeded.

A 4.7 μ F bypass capacitor is required at VL to ensure that the regulator is stable. A 1 μ F bypass capacitor is also required between REF and GND to ensure that the internal 4.2V reference is stable. In both cases, use a low-ESR ceramic capacitor.

Package Information

For the latest package outline information and land patterns (footprints), go to www.maximintegrated.com/packages. Note that a "+", "#", or "-" in the package code indicates RoHS status only. Package drawings may show a different suffix character, but the drawing pertains to the package regardless of RoHS status.

PACKAGE TYPE	PACKAGE CODE	OUTLINE NO.	LAND PATTERN NO.
5 SOT23	U5-2	21-0056	90-0095

Revision History

REVISION NUMBER	REVISION DATE	DESCRIPTION	PAGES CHANGED
0	6/00	Initial release	—
1	4/13	Corrected labels in Figure 1 and removed <i>Chip Information</i> section	9, 16
2	5/15	Updated <i>Benefits and Features</i> section	1

For pricing, delivery, and ordering information, please contact Maxim Direct at 1-888-629-4642, or visit Maxim Integrated's website at www.maximintegrated.com.

Maxim Integrated cannot assume responsibility for use of any circuitry other than circuitry entirely embodied in a Maxim Integrated product. No circuit patent licenses are implied. Maxim Integrated reserves the right to change the circuitry and specifications without notice at any time. The parametric values (min and max limits) shown in the Electrical Characteristics table are guaranteed. Other parametric values quoted in this data sheet are provided for guidance.

Mouser Electronics

Authorized Distributor

Click to View Pricing, Inventory, Delivery & Lifecycle Information:

[Maxim Integrated:](#)

[MAX1757EAI+](#) [MAX1757EAI+T](#)