



MIC23150

4MHz, PWM, 2A Buck Regulator with HyperLight Load[®]

General Description

The MIC23150 is a high-efficiency 4MHz 2A synchronous buck regulator with HyperLight Load[®] mode. HyperLight Load provides very high efficiency at light loads and ultra-fast transient response which is perfectly suited for supplying processor core voltages. An additional benefit of this proprietary architecture is very low output ripple voltage throughout the entire load range with the use of small output capacitors. The tiny 2mm x 2mm Thin DFN (TDFN) package saves precious board space and requires only three external components.

The MIC23150 is designed for use with a very small inductor, down to 0.47μH, and an output capacitor as small as 2.2 μF that enables a total solution size, less than 1mm height.

The MIC23150 has a very low quiescent current of 23μA and achieves a peak efficiency of 93% in continuous conduction mode. In discontinuous conduction mode, the MIC23150 can achieve 87% efficiency at 1mA.

The MIC23150 is available in 8-pin 2mm x 2mm Thin DFN package with an operating junction temperature range from -40°C to +125°C.

Datasheets and support documentation are available on Micrel's web site at: www.micrel.com.



HyperLight Load[®]

Features

- Input voltage: 2.7V to 5.5V
- 2A output current
- Up to 93% peak efficiency
- 87% typical efficiency at 1mA
- 23μA typical quiescent current
- 4MHz PWM operation in continuous mode
- Ultra-fast transient response
- Low ripple output voltage
 - 14mVpp ripple in HyperLight Load mode
 - 5mV output voltage ripple in full PWM mode
- 0.01μA shutdown current
- Thermal-shutdown and current-limit protection
- Output voltage as low as 0.95V
- 8-pin 2mm x 2mm Thin DFN (TDFN) package

Applications

- Mobile handsets
- Portable media/MP3 players
- Portable navigation devices (GPS)
- WiFi/WiMax/WiBro modules
- Solid State Drives/Memory
- Wireless LAN cards

Typical Application

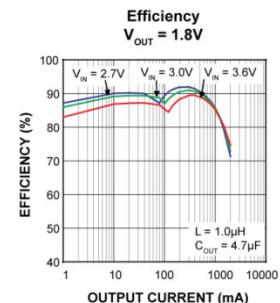
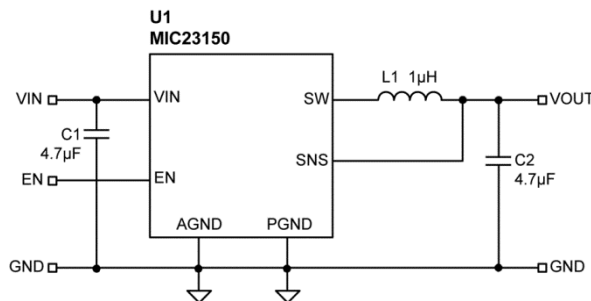

HyperLight Load is a registered trademark of Micrel, Inc.

Micrel Inc. • 2180 Fortune Drive • San Jose, CA 95131 • USA • tel +1 (408) 944-0800 • fax + 1 (408) 474-1000 • <http://www.micrel.com>

Ordering Information

Part Number	Marking Code ⁽¹⁾	Nominal Output Voltage ⁽²⁾	Junction Temperature Range	Package ⁽³⁾	Lead Finish
MIC23150-CYMT	QKC	1.0V	-40°C to +125°C	8-Pin 2mm x 2mm TDFN	Pb-Free
MIC23150-4YMT	QK4	1.2V	-40°C to +125°C	8-Pin 2mm x 2mm TDFN	Pb-Free
MIC23150-55YMT	QKZ	1.35V	-40°C to +125°C	8-Pin 2mm x 2mm TDFN	Pb-Free
MIC23150-GYMT	QKG	1.8V	-40°C to +125°C	8-Pin 2mm x 2mm TDFN	Pb-Free
MIC23150-SYMT	QKS	3.3V	-40°C to +125°C	8-Pin 2mm x 2mm TDFN	Pb-Free

Notes:

- ▲ = Pin 1 identifier.
- Other voltages are available. Contact Micrel for details.
- GREEN, RoHS-compliant package. Lead finish is NiPdAu. Mold compound is Halogen-Free.

Pin Configuration

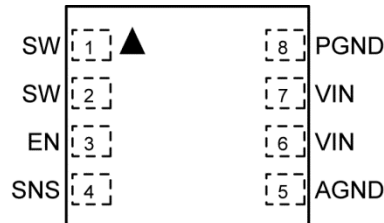

8-Pin 2mm x 2mm Thin DFN (MM)
(Top View)

Pin Description

Pin Number	Pin Name	Pin Function
1, 2	SW	Switch (Output): Internal power MOSFET output switches.
3	EN	Enable (Input): Logic high enables operation of the regulator. Logic low will shut down the device. Do not leave floating.
4	SNS	Sense: Connect to V_{OUT} as close to output capacitor as possible to sense output voltage.
5	AGND	Analog Ground: Connect to central ground point where all high current paths meet (C_{IN} , C_{OUT} , and PGND) for best operation.
6, 7	VIN	Input Voltage: Connect a capacitor-to-ground to decouple the noise.
8	PGND	Power Ground.

Absolute Maximum Ratings⁽⁴⁾

Supply Voltage (V_{IN})	6V
Sense (V_{SNS})	6V
Output Switch Voltage (V_{SW})	6V
Enable Input Voltage (V_{EN})	-0.3V to V_{IN}
Storage Temperature Range	-65°C to +150°C
ESD Rating ⁽⁶⁾	2kV

Operating Ratings⁽⁵⁾

Supply Voltage (V_{IN})	2.7V to 5.5V
Enable Input Voltage (V_{EN})	0V to V_{IN}
Junction Temperature Range (T_J)	-40°C ≤ T_J ≤ +125°C
Thermal Resistance	
8-pin 2mm × 2mm Thin DFN (θ_{JA})	90°C/W

Electrical Characteristics⁽⁷⁾

$T_A = 25^\circ\text{C}$; $V_{IN} = V_{EN} = 3.6\text{V}$; $L = 1.0\mu\text{H}$; $C_{OUT} = 4.7\mu\text{F}$ unless otherwise specified. **Bold** values indicate $-40^\circ\text{C} \leq T_J \leq +125^\circ\text{C}$, unless noted.

Parameter	Condition	Min.	Typ.	Max.	Units
Supply Voltage Range		2.7		5.5	V
Undervoltage Lockout Threshold	(Turn-on)	2.45	2.55	2.65	V
Undervoltage Lockout Hysteresis			75		mV
Quiescent Current	$I_{OUT} = 0\text{mA}$, $SNS > 1.2 \times V_{OUTNOM}$		23	40	μA
Shutdown Current	$V_{EN} = 0\text{V}$; $V_{IN} = 5.5\text{V}$		0.01	5	μA
Output Voltage Accuracy	$V_{IN} = 3.6\text{V}$ if $V_{OUTNOM} < 2.5\text{V}$, $I_{LOAD} = 20\text{mA}$	-2.5		+2.5	%
	$V_{IN} = 4.5\text{V}$ if $V_{OUTNOM} \geq 2.5\text{V}$, $I_{LOAD} = 20\text{mA}$				
Current Limit	$SNS = 0.9 \times V_{OUTNOM}$	2.2	3.4		A
Output Voltage Line Regulation	$V_{IN} = 3.6\text{V}$ to 5.5V if $V_{OUTNOM} < 2.5\text{V}$, $I_{LOAD} = 20\text{mA}$		0.3		%/V
	$V_{IN} = 4.5\text{V}$ to 5.5V if $V_{OUTNOM} \geq 2.5\text{V}$, $I_{LOAD} = 20\text{mA}$				
Output Voltage Load Regulation	$20\text{mA} < I_{LOAD} < 500\text{mA}$, $V_{IN} = 3.6\text{V}$ if $V_{OUTNOM} < 2.5\text{V}$		0.75		%/A
	$20\text{mA} < I_{LOAD} < 500\text{mA}$, $V_{IN} = 5.0\text{V}$ if $V_{OUTNOM} \geq 2.5\text{V}$				
PWM Switch ON-Resistance	$I_{SW} = 100\text{mA}$ PMOS		0.150		Ω
	$I_{SW} = -100\text{mA}$ NMOS		0.110		
Switching Frequency	$I_{OUT} = 120\text{mA}$		4		MHz
Soft-Start Time	$V_{OUT} = 90\%$		115		μs
Enable Threshold	Turn-on	0.5	0.8	1.2	V
Enable Input Current			0.1	2	μA
Overtemperature Shutdown			160		$^\circ\text{C}$
Overtemperature Shutdown Hysteresis			20		$^\circ\text{C}$

Notes:

- Exceeding the absolute maximum ratings may damage the device.
- The device is not guaranteed to function outside its operating ratings.
- Devices are ESD sensitive. Handling precautions are recommended. Human body model, 1.5k Ω in series with 100pF.
- Specification for packaged product only

Typical Characteristics

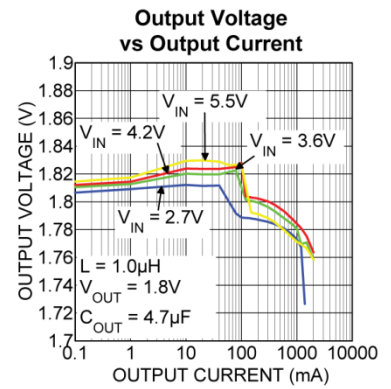
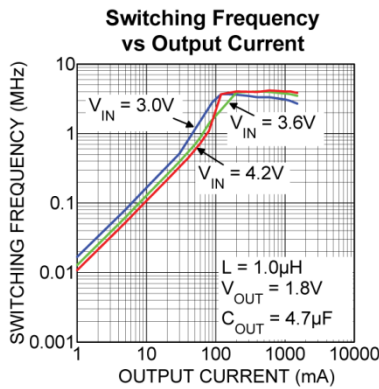
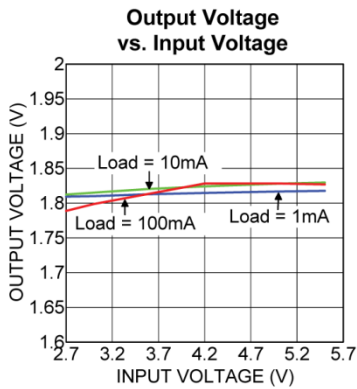
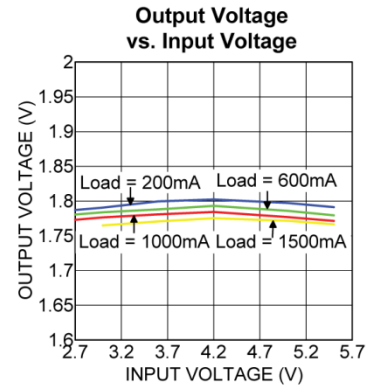
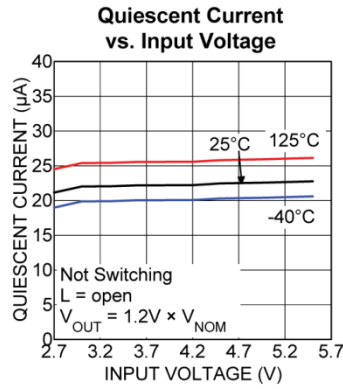
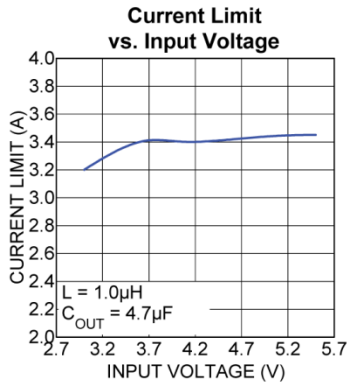
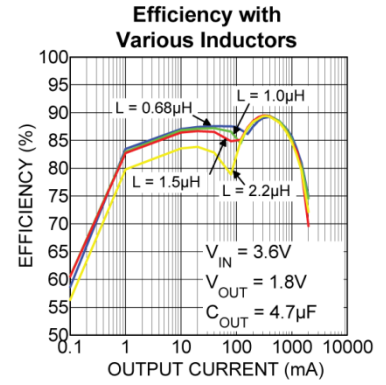
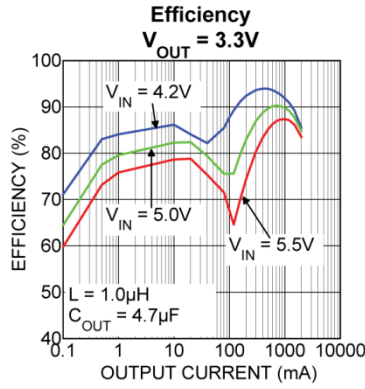
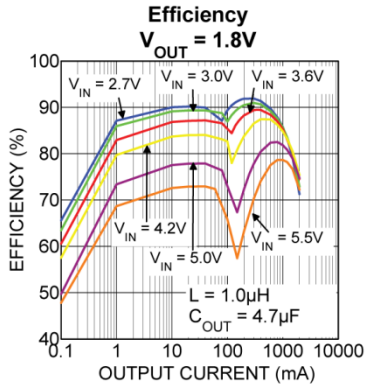

Typical Characteristics (Continued)

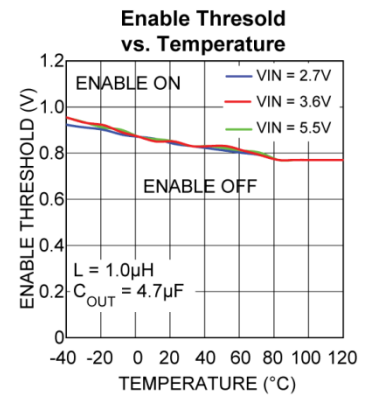
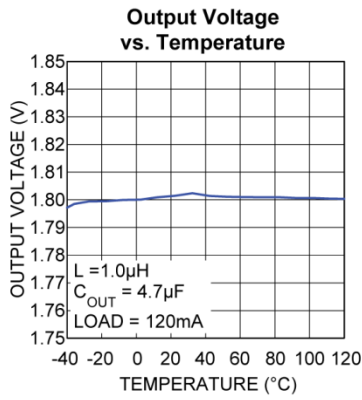
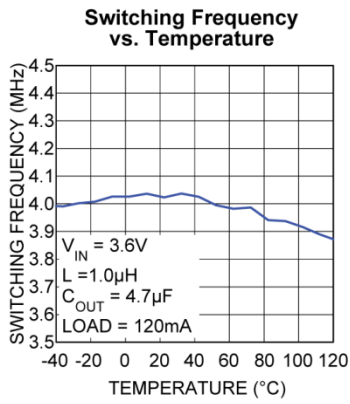

Functional Characteristics

**Switching Waveform
Discontinuous Mode – 1mA**

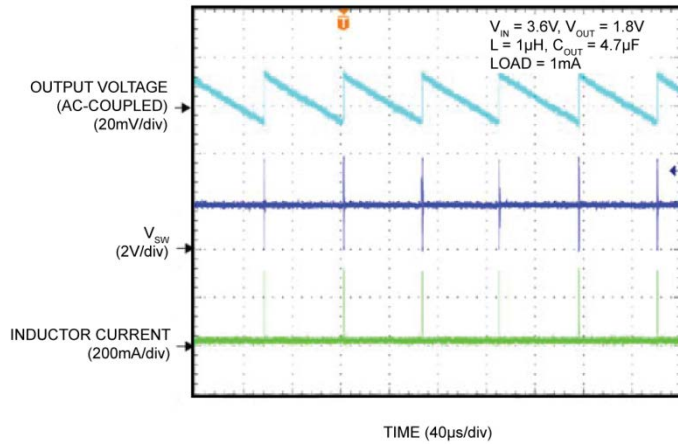

**Switching Waveform
Discontinuous Mode – 10mA**

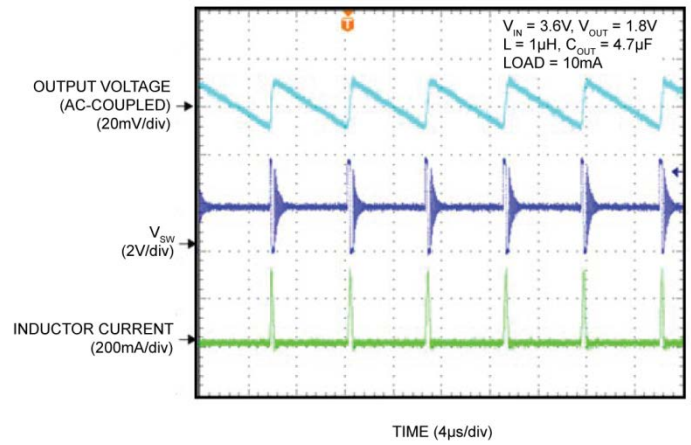

**Switching Waveform
Discontinuous Mode – 50mA**

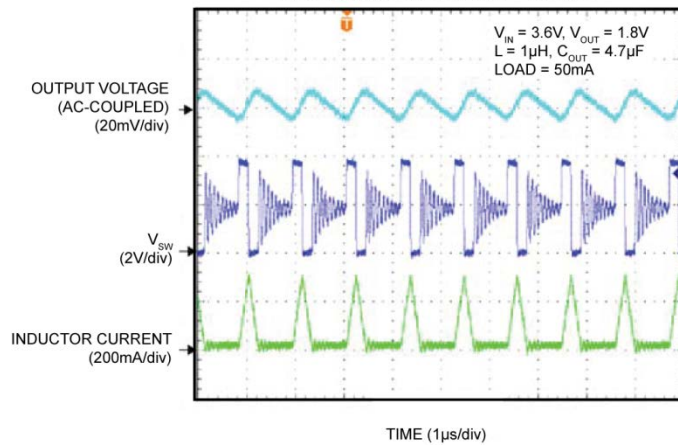

**Switching Waveform
Continuous Mode – 150mA**

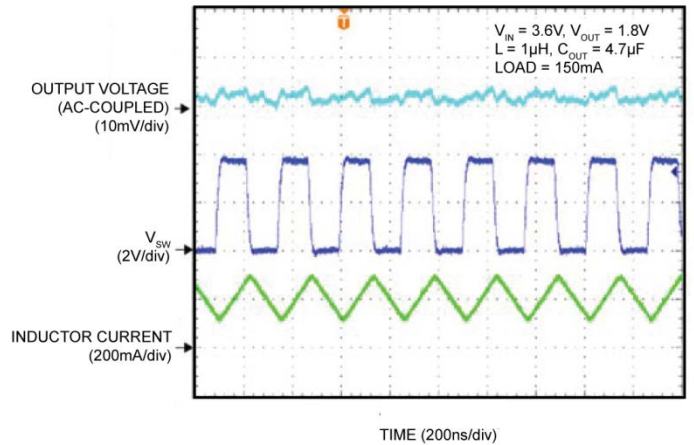

**Switching Waveform
Continuous Mode – 500mA**

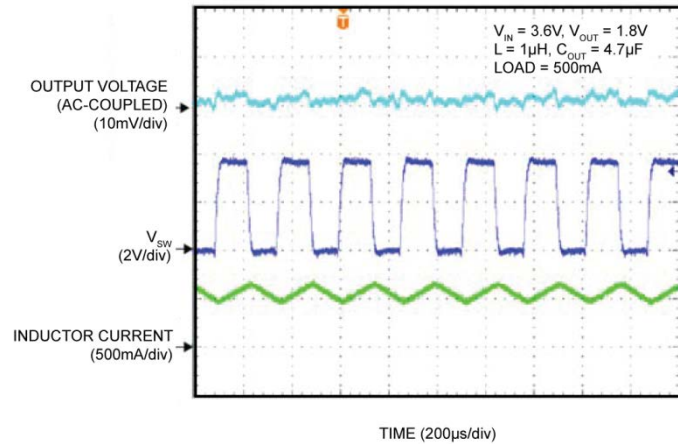

**Switching Waveform
Continuous Mode – 1.5A**

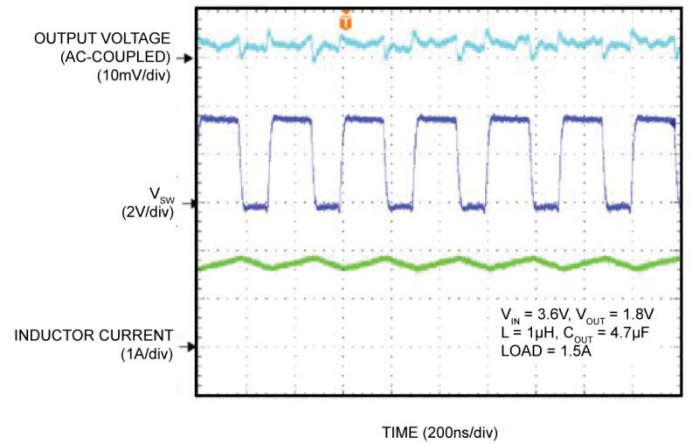

Functional Characteristics (Continued)

**Load Transient
10mA to 200mA**

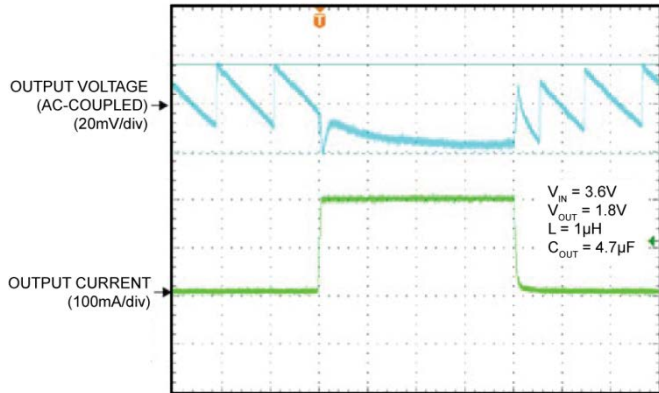

TIME (200ns/div)

**Load Transient
10mA to 500mA**

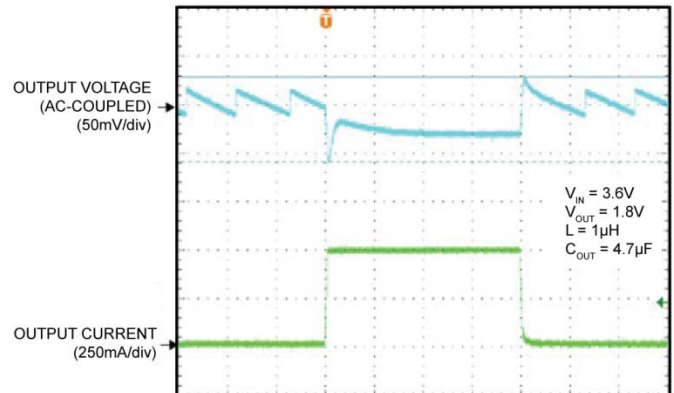

TIME (20ns/div)

**Load Transient
10mA to 750mA**

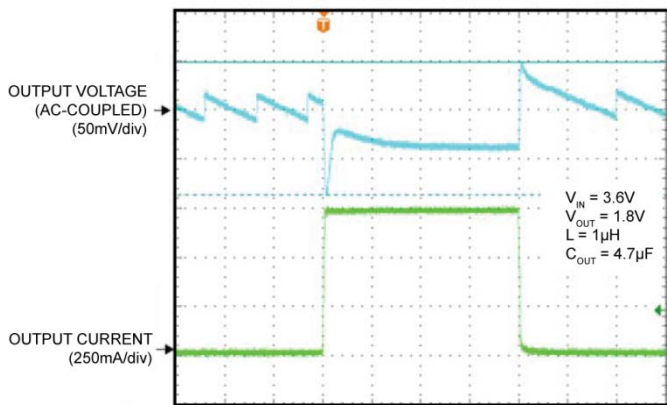

TIME (20ns/div)

**Load Transient
50mA to 1A**

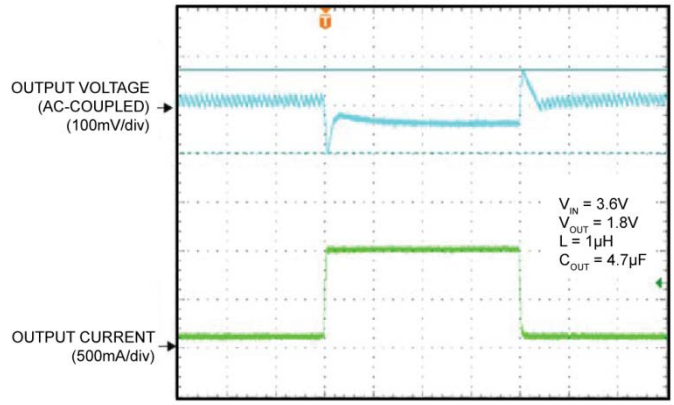

TIME (20ns/div)

**Load Transient
50mA to 1.5A**

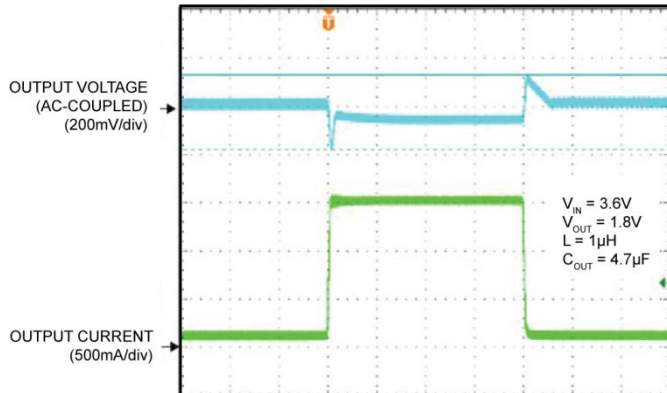

TIME (20ns/div)

**Load Transient
200mA to 600mA**

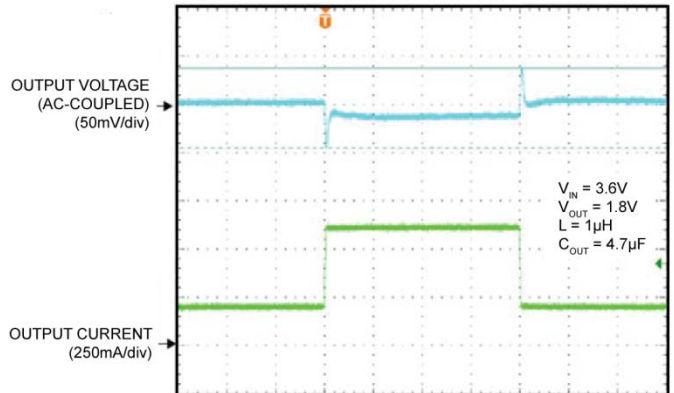

TIME (40ns/div)

Functional Characteristics (Continued)

**Load Transient
200mA to 1A**

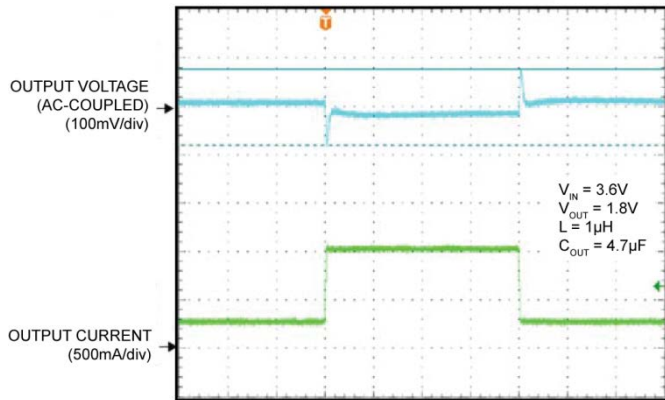

TIME (40µs/div)

**Load Transient
200mA to 1.5A**

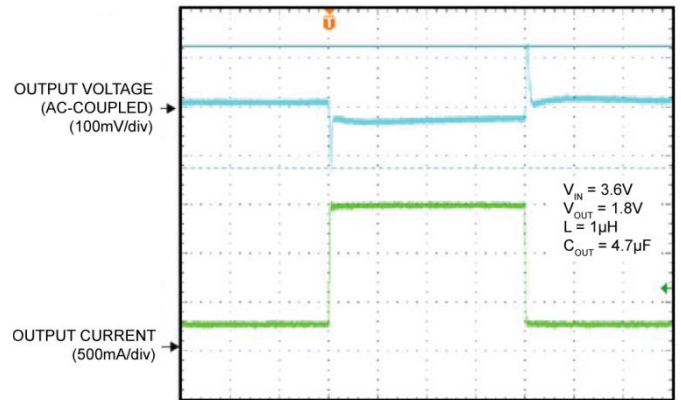

TIME (40µs/div)

**Line Transient
2.7V to 5.5V**

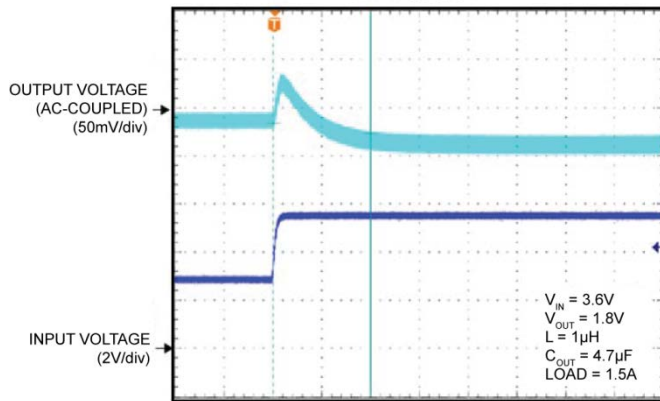

TIME (40µs/div)

**Line Transient
5.5V to 2.7V**

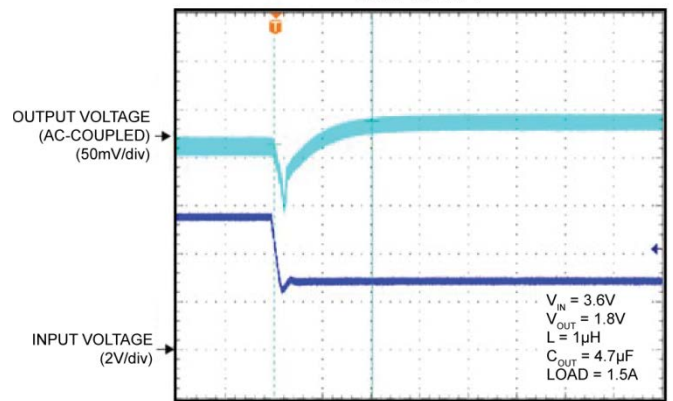

TIME (40µs/div)

Start-Up Waveform

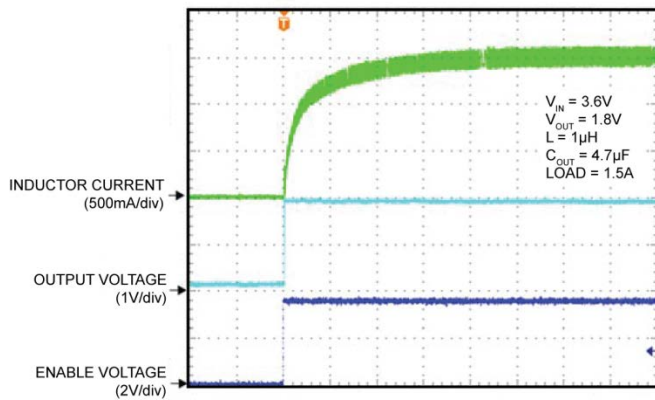

TIME (10ms/div)

Start-Up Waveform

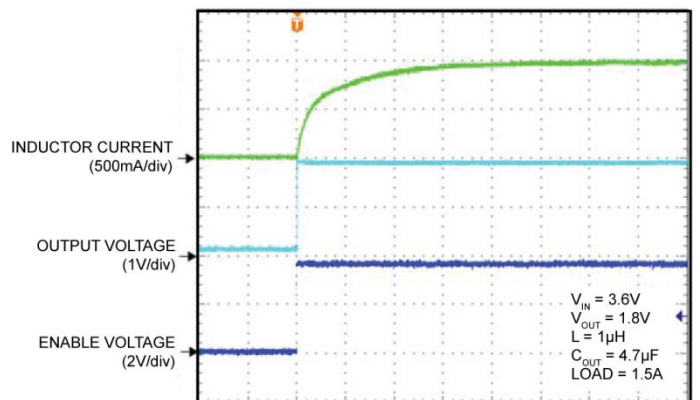

TIME (10ms/div)

Functional Characteristics (Continued)

Turn-On Time

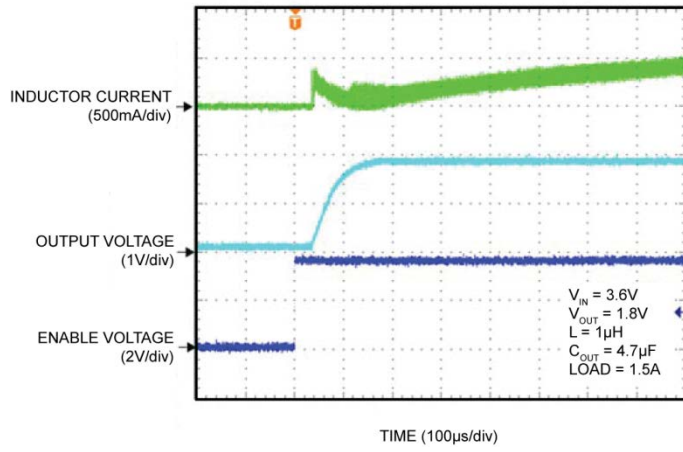

Functional Diagram

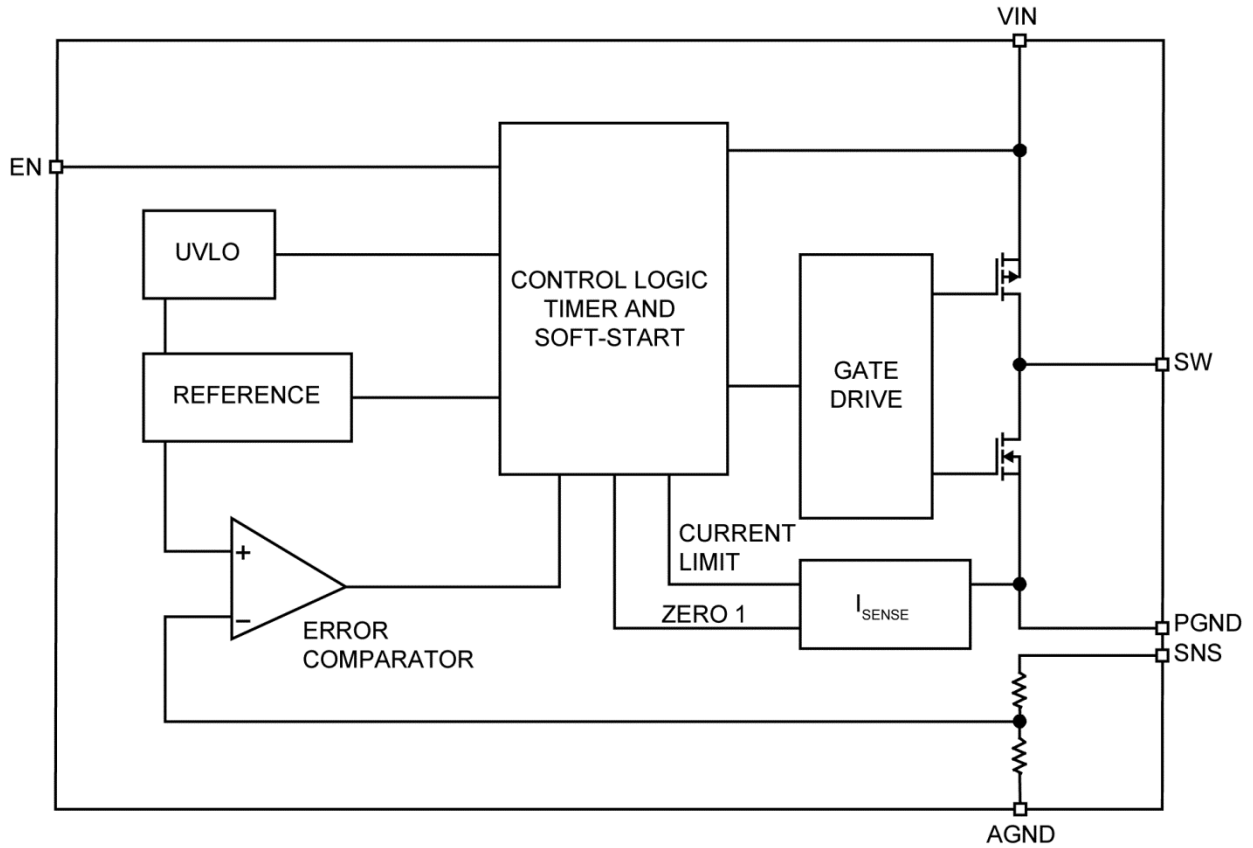

Functional Description

VIN

The input supply (VIN) provides power to the internal MOSFETs for the switch mode regulator along with the internal control circuitry. The VIN operating range is 2.7V to 5.5V so an input capacitor, with a minimum voltage rating of 6.3V, is recommended. Due to the high switching speed, a minimum 2.2 μ F bypass capacitor placed close to VIN and the power ground (PGND) pin is required. Refer to the [PCB Layout Recommendations](#) for details.

EN

A logic high signal on the enable pin activates the output voltage of the device. A logic low signal on the enable pin deactivates the output and reduces supply current to 0.01 μ A. MIC23150 features built-in soft-start circuitry that reduces in-rush current and prevents the output voltage from overshooting at start up. Do not leave the EN pin floating.

SW

The switch (SW) connects directly to one end of the inductor and provides the current path during switching cycles. The other end of the inductor is connected to the load, SNS pin and output capacitor. Due to the high speed switching on this pin, the switch node should be routed away from sensitive nodes whenever possible.

SNS

The sense (SNS) pin is connected to the output of the device to provide feedback to the control circuitry. The SNS connection should be placed close to the output capacitor. Refer to the [PCB Layout Recommendations](#) for more details.

AGND

The analog ground (AGND) is the ground path for the biasing and control circuitry. The current loop for the signal ground should be separate from the power ground (PGND) loop. Refer to the [PCB Layout Recommendations](#) for more details.

PGND

The power ground pin is the ground path for the high current in PWM mode. The current loop for the power ground should be as small as possible and separate from the analog ground (AGND) loop as applicable. Refer to the [PCB Layout Recommendations](#) for more details.

Application Information

The MIC23150 is a high-performance DC-to-DC step down regulator offering a small solution size. Supporting an output current up to 2A inside a tiny 2mm × 2mm Thin DFN package, the IC requires only three external components while meeting today's miniature portable electronic device needs. Using the HyperLight Load switching scheme, the MIC23150 is able to maintain high efficiency throughout the entire load range while providing ultra-fast load transient response. The following sections provide additional device application information.

Input Capacitor

A 2.2μF ceramic capacitor or greater should be placed close to the VIN pin and PGND pin for bypassing. A TDK C1608X5R0J475K, size 0603, 4.7μF ceramic capacitor is recommended based upon performance, size and cost. A X5R or X7R temperature rating is recommended for the input capacitor. Y5V temperature rating capacitors, aside from losing most of their capacitance over temperature, can also become resistive at high frequencies. This reduces their ability to filter out high-frequency noise.

Output Capacitor

The MIC23150 is designed for use with a 2.2μF or greater ceramic output capacitor. Increasing the output capacitance will lower output ripple and improve load transient response but could also increase solution size or cost. A low equivalent series resistance (ESR) ceramic output capacitor such as the TDK C1608X5R0J475K, size 0603, 4.7μF ceramic capacitor is recommended based upon performance, size and cost. Both the X7R or X5R temperature rating capacitors are recommended. The Y5V and Z5U temperature rating capacitors are not recommended due to their wide variation in capacitance over temperature and increased resistance at high frequencies.

Inductor Selection

When selecting an inductor, it is important to consider the following factors (not necessarily in the order of importance):

- Inductance
- Rated current value
- Size requirements
- DC resistance (DCR)

The MIC23150 is designed for use with a 0.47μH to 2.2μH inductor. For faster transient response, a 0.47μH inductor will yield the best result. For lower output ripple, a 2.2μH inductor is recommended.

Maximum current ratings of the inductor are generally given in two methods; permissible DC current and saturation current. Permissible DC current can be rated either for a 40°C temperature rise or a 10% to 20% loss in inductance. Ensure the inductor selected can handle the maximum operating current. When saturation current is specified, make sure that there is enough margin so that the peak current does not cause the inductor to saturate. Peak current can be calculated as in Equation 1:

$$I_{PEAK} = \left[I_{OUT} + V_{OUT} \left(\frac{1 - V_{OUT} / V_{IN}}{2 \times f \times L} \right) \right] \quad \text{Eq. 1}$$

As shown in Equation 1, the peak inductor current is inversely proportional to the switching frequency and the inductance; the lower the switching frequency or the inductance the higher the peak current. As input voltage increases, the peak current also increases.

The size of the inductor depends on the requirements of the application. Refer to the [Typical Application Schematic](#) and [Bill of Materials](#) sections for details.

DC resistance (DCR) is also important. While DCR is inversely proportional to size, DCR can represent a significant efficiency loss. Refer to the ["Efficiency Considerations"](#) sub-section.

Compensation

The MIC23150 is designed to be stable with a 0.47μH to 2.2μH inductor with a minimum of 2.2μF ceramic (X5R) output capacitor.

Duty Cycle

The typical maximum duty cycle of the MIC23150 is 80%.

Efficiency Considerations

Efficiency is defined as the amount of useful output power, divided by the amount of power supplied.

$$\text{Efficiency}\% = \left(\frac{V_{OUT} \times I_{OUT}}{V_{IN} \times I_{IN}} \right) \times 100 \quad \text{Eq. 2}$$

Maintaining high efficiency serves two purposes. It reduces power dissipation in the power supply, reducing the need for heat sinks and thermal design considerations and it reduces consumption of current for battery-powered applications. Reduced current draw from a battery increases the devices operating time and is critical in hand held devices.

There are two types of losses in switching converters; DC losses and switching losses. DC losses are simply the power dissipation of I^2R . Power is dissipated in the high-side switch during the on cycle. Power loss is equal to the high side MOSFET $R_{DS(ON)}$ multiplied by the switch current squared. During the off cycle, the low side N-channel MOSFET conducts, also dissipating power. Device operating current also reduces efficiency. The product of the quiescent (operating) current and the supply voltage represents another DC loss. The current required driving the gates on and off at a constant 4MHz frequency and the switching transitions make up the switching losses.

Figure 1 shows an efficiency curve. From no load to 100mA, efficiency losses are dominated by quiescent current losses, gate drive and transition losses. By using the HyperLight Load mode, the MIC23150 is able to maintain high efficiency at low output currents.

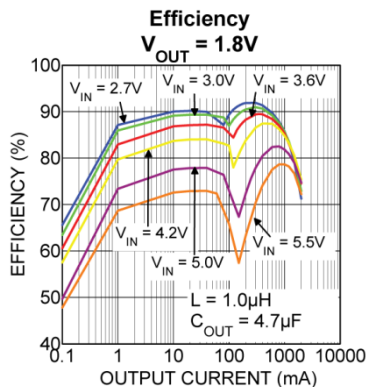

Figure 1. Efficiency Under Load

Over 100mA, efficiency loss is dominated by MOSFET $R_{DS(ON)}$ and inductor losses. Higher input supply voltages will increase the gate-to-source threshold on the internal MOSFETs, thereby reducing the internal $R_{DS(ON)}$. This improves efficiency by reducing DC losses in the device. All but the inductor losses are inherent to the device. In which case, inductor selection becomes increasingly critical in efficiency calculations. As the inductors are reduced in size, the DC resistance (DCR) can become quite significant.

The DCR losses can be calculated as shown in Equation 3:

$$P_{DCR} = I_{OUT}^2 \times DCR \quad \text{Eq. 3}$$

From that, the loss in efficiency due to inductor resistance can be calculated as in Equation 4:

$$\text{Efficiency Loss} = \left[1 - \left(\frac{V_{OUT} \times I_{OUT}}{V_{OUT} \times I_{OUT} + P_{DCR}} \right) \right] \times 100 \quad \text{Eq. 4}$$

Efficiency loss due to DCR is minimal at light loads and gains significance as the load is increased. Inductor selection becomes a trade-off between efficiency and size in this case.

HyperLight Load Mode

MIC23150 uses a minimum on and off time proprietary control loop (patented by Micrel). When the output voltage falls below the regulation threshold, the error comparator begins a switching cycle that turns the PMOS on and keeps it on for the duration of the minimum-on-time. This increases the output voltage. If the output voltage is over the regulation threshold, then the error comparator turns the PMOS off for a minimum-off-time until the output drops below the threshold. The NMOS acts as an ideal rectifier that conducts when the PMOS is off. Using a NMOS switch instead of a diode allows for lower voltage drop across the switching device when it is on. The asynchronous switching combination between the PMOS and the NMOS allows the control loop to work in discontinuous mode for light load operations. In discontinuous mode, the MIC23150 works in pulse frequency modulation (PFM) to regulate the output. As the output current increases, the off-time decreases, thus provides more energy to the output. This switching scheme improves the efficiency of MIC23150 during light load currents by only switching when it is needed. As the load current increases, the MIC23150 goes into continuous conduction mode (CCM) and switches at a frequency centered at 4MHz. The equation to calculate the load when the MIC23150 goes into continuous conduction mode may be approximated by Equation 5:

$$I_{LOAD} > \left(\frac{(V_{IN} - V_{OUT}) \times D}{2L \times f} \right) \quad \text{Eq. 5}$$

As shown in Equation 5, the load at which MIC23150 transitions from HyperLight Load mode to PWM mode is a function of the input voltage (V_{IN}), output voltage (V_{OUT}), duty cycle (D), inductance (L) and frequency (f). As shown in Figure 2, as the output current increases, the switching frequency also increases until the MIC23150 goes from HyperLight Load mode to PWM mode at approximately 120mA. The MIC23150 will switch at a relatively constant frequency around 4MHz once the output current is over 120mA.

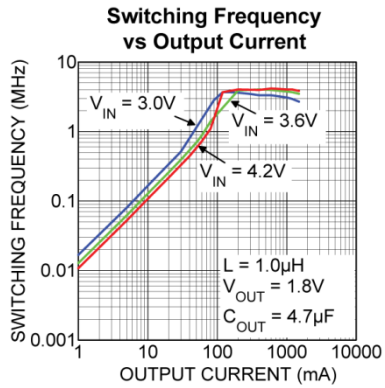
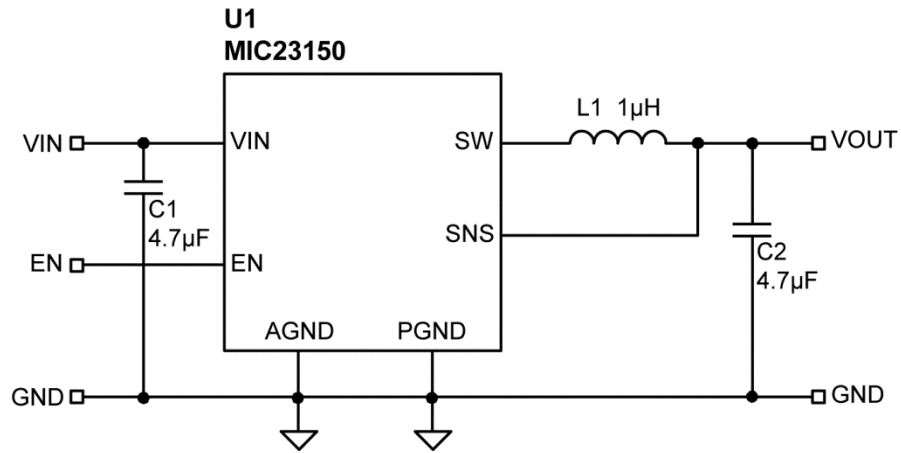

Figure 2. SW Frequency vs. Output Current

Typical Application Schematic



Bill of Materials

Item	Part Number	Manufacturer	Description	Qty.
C1, C2	C1608X5R0J475K	TDK ⁽⁸⁾	4.7µF Ceramic Capacitor, 6.3V, X5R, Size 0603	2
L1	VLS3010T-1R0N1R9	TDK	1µH, 1.9A, 60mΩ, L3.0mm × W3.0mm × H1.0mm	1
	VLS4012T-1R0N1R6	TDK	1µH, 2.8A, 50mΩ, L4.0mm × W4.0mm × H1.2mm	
	DO2010-102ML	Coilcraft ⁽⁹⁾	1µH, 1.8A, 162mΩ, L2.0mm × W2.0mm × H1.0mm	
U1	MIC23150-xYMT	Micrel, Inc. ⁽¹⁰⁾	4MHz 2A Buck Regulator with HyperLight Load Mode	1

Notes:

- 8. TDK: www.tdk.com.
- 9. Coilcraft: www.coilcraft.com.
- 10. Micrel, Inc.: www.micrel.com.

PCB Layout Recommendations

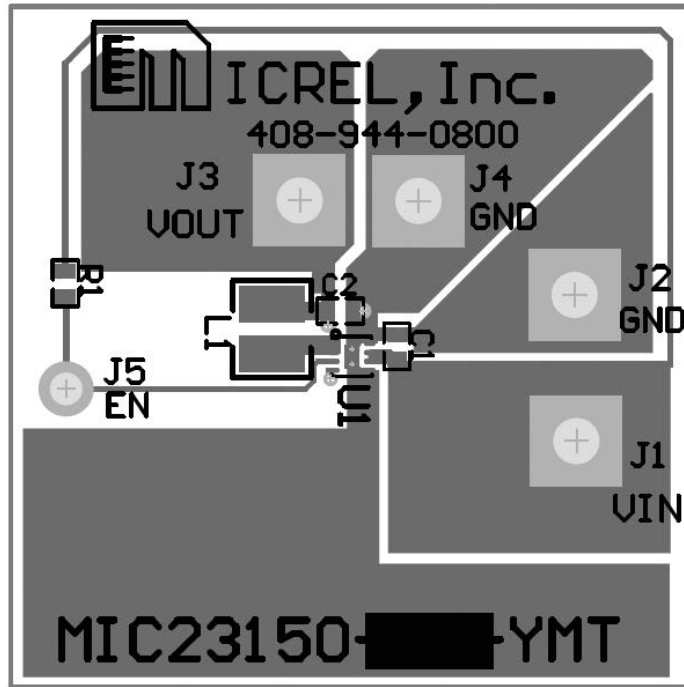

Top Layer

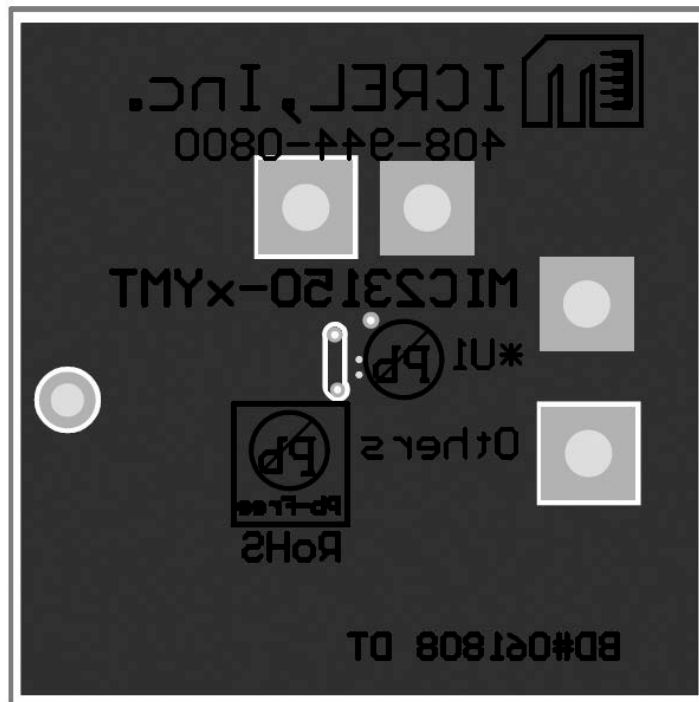

Bottom Layer

Package Information and Recommended Landing Pattern⁽¹¹⁾

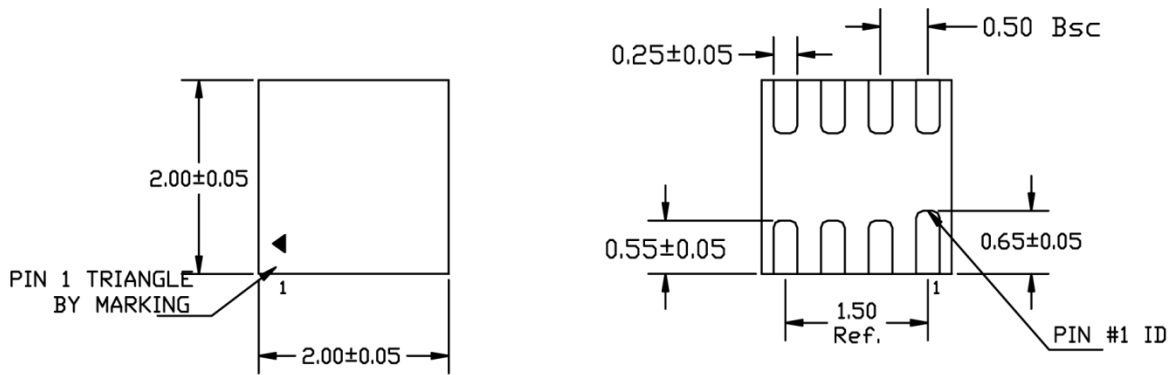

TOP VIEW
NOTE: 1, 2, 3

BOTTOM VIEW
NOTE: 1, 2, 3

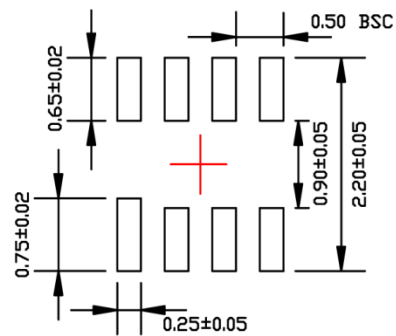
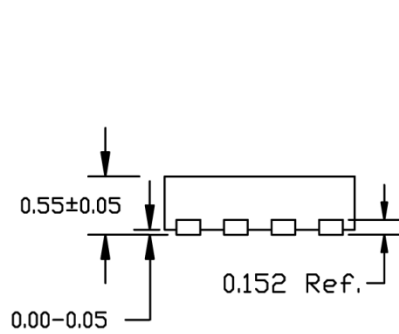

SIDE VIEW
NOTE: 1, 2, 3

RECOMMENDED LAND PATTERN

NOTE:

1. MAX PACKAGE WARPAGE IS 0.08 MM
2. MAX ALLOWABLE BURR IS 0.076MM IN ALL DIRECTIONS
3. PIN #1 IS ON TOP WILL BE LASER MARKED

8-Pin 2mm x 2mm TDFN (MM)

Note:

11. Package information is correct as of the publication date. For updates and most current information, go to www.micrel.com.

MICREL, INC. 2180 FORTUNE DRIVE SAN JOSE, CA 95131 USA
TEL +1 (408) 944-0800 FAX +1 (408) 474-1000 WEB <http://www.micrel.com>

Micrel, Inc. is a leading global manufacturer of IC solutions for the worldwide high performance linear and power, LAN, and timing & communications markets. The Company's products include advanced mixed-signal, analog & power semiconductors; high-performance communication, clock management, MEMs-based clock oscillators & crystal-less clock generators, Ethernet switches, and physical layer transceiver ICs. Company customers include leading manufacturers of enterprise, consumer, industrial, mobile, telecommunications, automotive, and computer products. Corporation headquarters and state-of-the-art wafer fabrication facilities are located in San Jose, CA, with regional sales and support offices and advanced technology design centers situated throughout the Americas, Europe, and Asia. Additionally, the Company maintains an extensive network of distributors and reps worldwide.

Micrel makes no representations or warranties with respect to the accuracy or completeness of the information furnished in this datasheet. This information is not intended as a warranty and Micrel does not assume responsibility for its use. Micrel reserves the right to change circuitry, specifications and descriptions at any time without notice. No license, whether express, implied, arising by estoppel or otherwise, to any intellectual property rights is granted by this document. Except as provided in Micrel's terms and conditions of sale for such products, Micrel assumes no liability whatsoever, and Micrel disclaims any express or implied warranty relating to the sale and/or use of Micrel products including liability or warranties relating to fitness for a particular purpose, merchantability, or infringement of any patent, copyright, or other intellectual property right.

Micrel Products are not designed or authorized for use as components in life support appliances, devices or systems where malfunction of a product can reasonably be expected to result in personal injury. Life support devices or systems are devices or systems that (a) are intended for surgical implant into the body or (b) support or sustain life, and whose failure to perform can be reasonably expected to result in a significant injury to the user. A Purchaser's use or sale of Micrel Products for use in life support appliances, devices or systems is a Purchaser's own risk and Purchaser agrees to fully indemnify Micrel for any damages resulting from such use or sale.

© 2008 Micrel, Incorporated.

Mouser Electronics

Authorized Distributor

Click to View Pricing, Inventory, Delivery & Lifecycle Information:

[Micrel:](#)

[MIC23150-SYMT TR](#) [MIC23150-GYMT TR](#) [MIC23150-CYMT-TR](#) [MIC23150-SYMT-TR](#) [MIC23150-4YMT-TR](#)
[MIC23150-55YMT-TR](#) [MIC23150-GYMT-TR](#)