

RF Power Field Effect Transistor

N-Channel Enhancement-Mode Lateral MOSFET

Designed for Class A or Class AB base station applications with frequencies up to 2000 MHz. Suitable for analog and digital modulation and multicarrier amplifier applications.

- Typical Two-Tone Performance @ 1960 MHz, 28 Volts, $I_{DQ} = 50$ mA,
 $P_{out} = 4$ Watts PEP
 Power Gain — 18 dB
 Drain Efficiency — 33%
 IMD — -34 dBc
- Typical Two-Tone Performance @ 900 MHz, 28 Volts, $I_{DQ} = 50$ mA,
 $P_{out} = 4$ Watts PEP
 Power Gain — 19 dB
 Drain Efficiency — 33%
 IMD — -39 dBc
- Capable of Handling 5:1 VSWR, @ 28 Vdc, 1960 MHz, 4 Watts CW Output Power

Features

- Characterized with Series Equivalent Large-Signal Impedance Parameters
- On-Chip RF Feedback for Broadband Stability
- Integrated ESD Protection
- RoHS Compliant
- In Tape and Reel. T1 Suffix = 1000 Units per 12 mm, 7 inch Reel.

MW6S004NT1

**1-2000 MHz, 4 W, 28 V
LATERAL N-CHANNEL
RF POWER MOSFET**

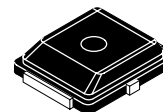

**CASE 466-03, STYLE 1
PLD 1.5
PLASTIC**

Table 1. Maximum Ratings

Rating	Symbol	Value	Unit
Drain-Source Voltage	V_{DSS}	-0.5, +68	Vdc
Gate-Source Voltage	V_{GS}	-0.5, +12	Vdc
Storage Temperature Range	T_{stg}	-65 to +150	°C
Operating Junction Temperature	T_J	150	°C

Table 2. Thermal Characteristics

Characteristic	Symbol	Value (1,2)	Unit
Thermal Resistance, Junction to Case Case Temperature 76°C, 4 W PEP, Two-Tone Case Temperature 79°C, 4 W CW	$R_{\theta JC}$	8.8 8.5	°C/W

Table 3. ESD Protection Characteristics

Test Methodology	Class
Human Body Model (per JESD22-A114)	1C (Minimum)
Machine Model (per EIA/JESD22-A115)	A (Minimum)
Charge Device Model (per JESD22-C101)	IV (Minimum)

1. MTTF calculator available at <http://www.freescale.com/rf>. Select Software & Tools/Development Tools/Calculators to access MTTF calculators by product.
2. Refer to AN1955, *Thermal Measurement Methodology of RF Power Amplifiers*. Go to <http://www.freescale.com/rf>. Select Documentation/Application Notes - AN1955.

Table 4. Moisture Sensitivity Level

Test Methodology	Rating	Package Peak Temperature	Unit
Per JESD 22-A113, IPC/JEDEC J-STD-020	3	260	°C

Table 5. Electrical Characteristics ($T_A = 25^\circ\text{C}$ unless otherwise noted)

Characteristic	Symbol	Min	Typ	Max	Unit
----------------	--------	-----	-----	-----	------

Off Characteristics

Zero Gate Voltage Drain Leakage Current ($V_{DS} = 68\text{ Vdc}$, $V_{GS} = 0\text{ Vdc}$)	I_{DSS}	—	—	10	μAdc
Zero Gate Voltage Drain Leakage Current ($V_{DS} = 28\text{ Vdc}$, $V_{GS} = 0\text{ Vdc}$)	I_{DSS}	—	—	10	μAdc
Gate-Source Leakage Current ($V_{GS} = 5\text{ Vdc}$, $V_{DS} = 0\text{ Vdc}$)	I_{GSS}	—	—	500	nAdc

On Characteristics

Gate Threshold Voltage ($V_{DS} = 10\text{ Vdc}$, $I_D = 50\text{ mAdc}$)	$V_{GS(th)}$	1.2	2	2.7	Vdc
Gate Quiescent Voltage ($V_{DS} = 28\text{ Vdc}$, $I_D = 50\text{ mAdc}$)	$V_{GS(Q)}$	—	2.7	—	Vdc
Fixture Gate Quiescent Voltage ⁽¹⁾ ($V_{DD} = 28\text{ Vdc}$, $I_D = 50\text{ mAdc}$, Measured in Functional Test)	$V_{GG(Q)}$	2.2	3	4.2	Vdc
Drain-Source On-Voltage ($V_{GS} = 10\text{ Vdc}$, $I_D = 50\text{ mAdc}$)	$V_{DS(on)}$	—	0.27	0.37	Vdc

Dynamic Characteristics

Reverse Transfer Capacitance ($V_{DS} = 28\text{ Vdc} \pm 30\text{ mV(rms)ac}$ @ 1 MHz, $V_{GS} = 0\text{ Vdc}$)	C_{rss}	—	21	—	pF
Output Capacitance ($V_{DS} = 28\text{ Vdc} \pm 30\text{ mV(rms)ac}$ @ 1 MHz, $V_{GS} = 0\text{ Vdc}$)	C_{oss}	—	25	—	pF
Input Capacitance ($V_{DS} = 28\text{ Vdc}$, $V_{GS} = 0\text{ Vdc} \pm 30\text{ mV(rms)ac}$ @ 1 MHz)	C_{iss}	—	30	—	pF

Functional Tests (In Freescale Test Fixture, 50 ohm system) $V_{DD} = 28\text{ Vdc}$, $I_{DQ} = 50\text{ mA}$, $P_{out} = 4\text{ W PEP}$, $f_1 = 1960\text{ MHz}$, $f_2 = 1960.1\text{ MHz}$, Two-Tone Test

Power Gain	G_{ps}	16.5	18	20	dB
Drain Efficiency	η_D	28	33	—	%
Intermodulation Distortion	IMD	—	-34	-28	dBc
Input Return Loss	IRL	—	-12	-10	dB

Typical Performance (In Freescale 900 MHz Demo Board, 50 ohm system) $V_{DD} = 28\text{ Vdc}$, $I_{DQ} = 50\text{ mA}$, $P_{out} = 4\text{ W PEP}$, $f = 900\text{ MHz}$, Two-Tone Test, 100 kHz Tone Spacing

Power Gain	G_{ps}	—	19	—	dB
Drain Efficiency	η_D	—	33	—	%
Intermodulation Distortion	IMD	—	-39	—	dBc
Input Return Loss	IRL	—	-12	—	dB

1. $V_{GG} = \frac{11}{10} \times V_{GS(Q)}$. Parameter measured on Freescale Test Fixture, due to resistive divider network on the board. Refer to Test Circuit Schematic.

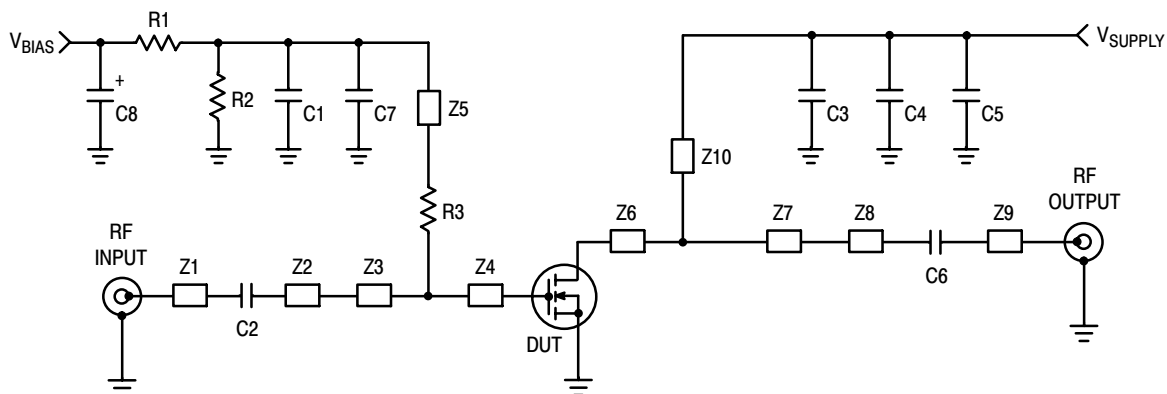

Z1	0.054" x 0.430" Microstrip	Z7	0.210" x 1.220" Microstrip
Z2	0.054" x 0.137" Microstrip	Z8	0.054" x 0.680" Microstrip
Z3	0.580" x 0.420" Microstrip	Z9	0.054" x 0.260" Microstrip
Z4	0.580" x 0.100" Microstrip	Z10	0.025" x 0.930" Microstrip
Z5	0.025" x 0.680" Microstrip	PCB	Arlon CuClad 250GX-0300-55-22, 0.020", $\epsilon_r = 2.5$
Z6	0.210" x 0.100" Microstrip		

Figure 1. MW6S004NT1 Test Circuit Schematic

Table 6. MW6S004NT1 Test Circuit Component Designations and Values

Part	Description	Part Number	Manufacturer
C1	100 nF Chip Capacitor	CDR33BX104AKYS	Kemet
C2, C3, C6, C7	9.1 pF Chip Capacitors	ATC100B9R1CT500XT	ATC
C4, C5	10 μ F, 50 V Chip Capacitors	GRM55DR61H106KA88B	Murata
C8	10 μ F, 35 V Tantalum Chip Capacitor	T490D106K035AT	Kemet
R1	1 k Ω , 1/4 W Chip Resistor	CRCW12061001FKEA	Vishay
R2	10 k Ω , 1/4 W Chip Resistor	CRCW12061002FKEA	Vishay
R3	10 Ω , 1/4 W Chip Resistor	CRCW120610R0FKEA	Vishay

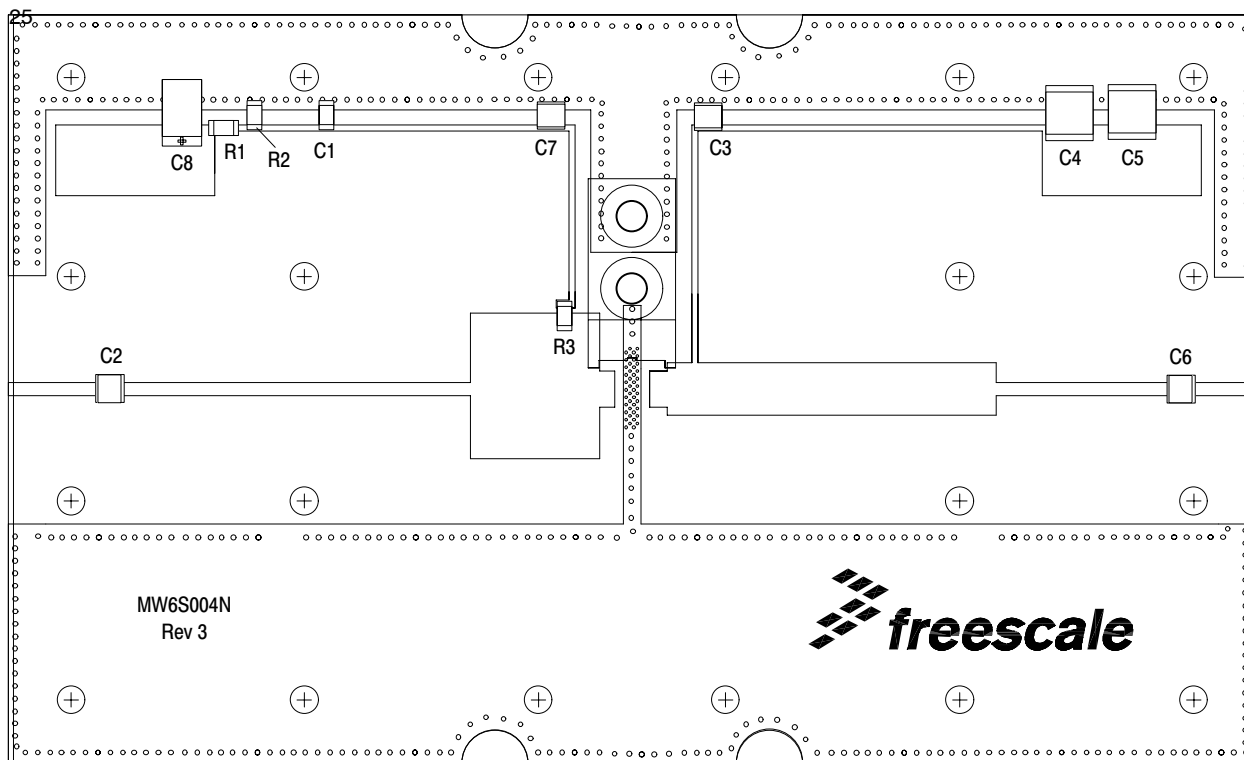

Figure 2. MW6S004NT1 Test Circuit Component Layout

TYPICAL CHARACTERISTICS

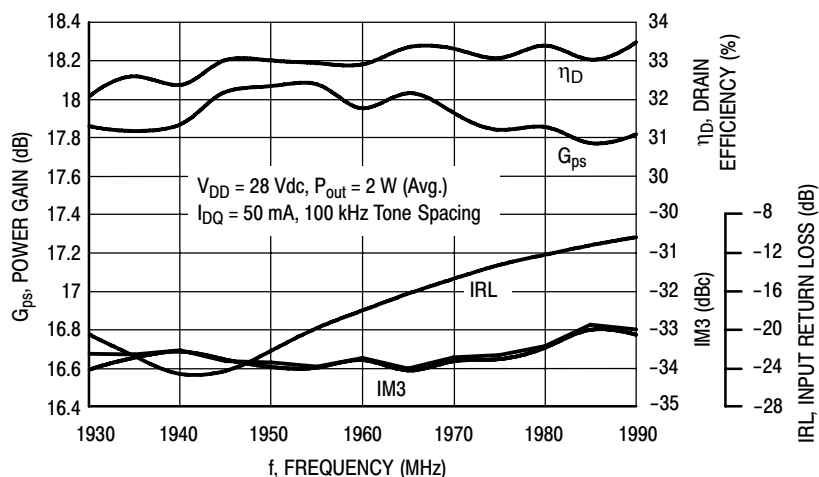

Figure 3. Two-Tone Wideband Performance @ P_{out} = 2 Watts Avg.

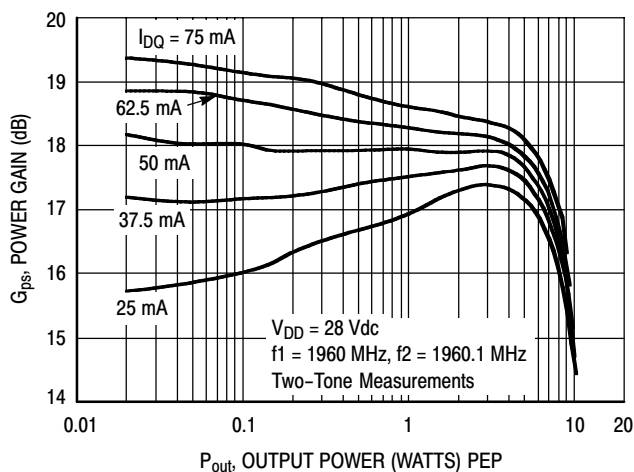

Figure 4. Two-Tone Power Gain versus Output Power

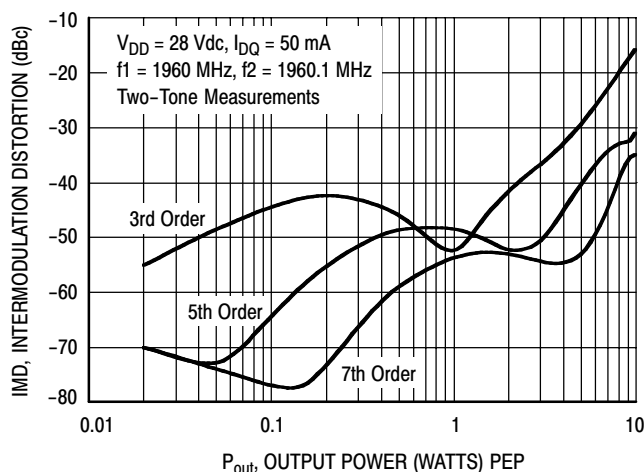

Figure 5. Intermodulation Distortion Products versus Output Power

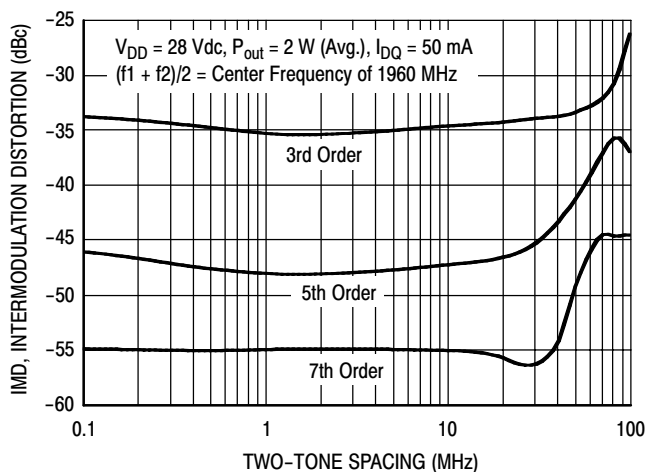

Figure 6. Intermodulation Distortion Products versus Tone Spacing

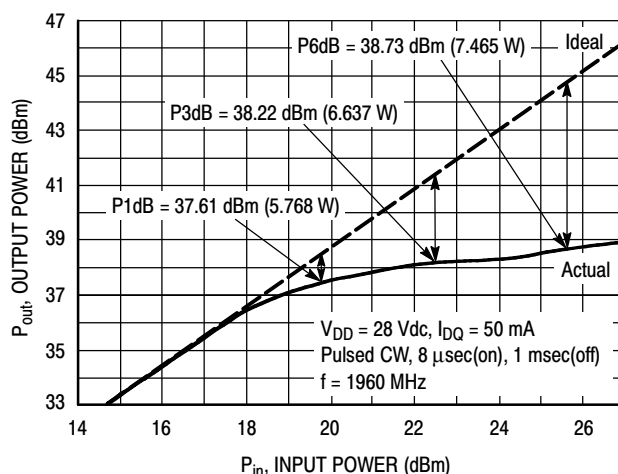

Figure 7. Pulsed CW Output Power versus Input Power

TYPICAL CHARACTERISTICS

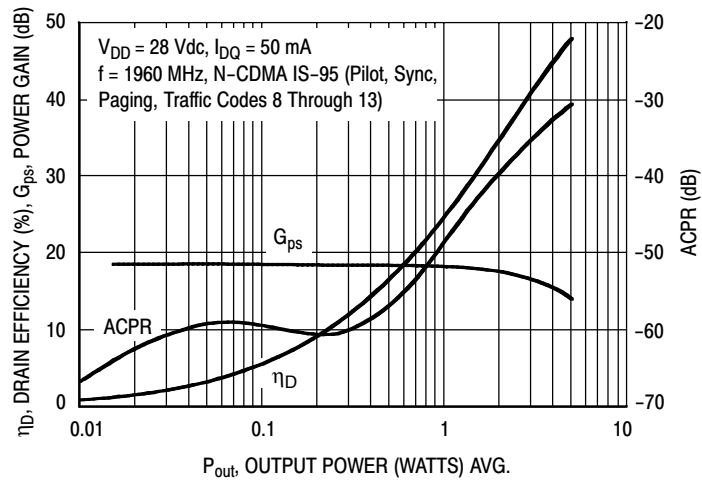

Figure 8. Single-Carrier CDMA ACPR, Power Gain and Drain Efficiency versus Output Power

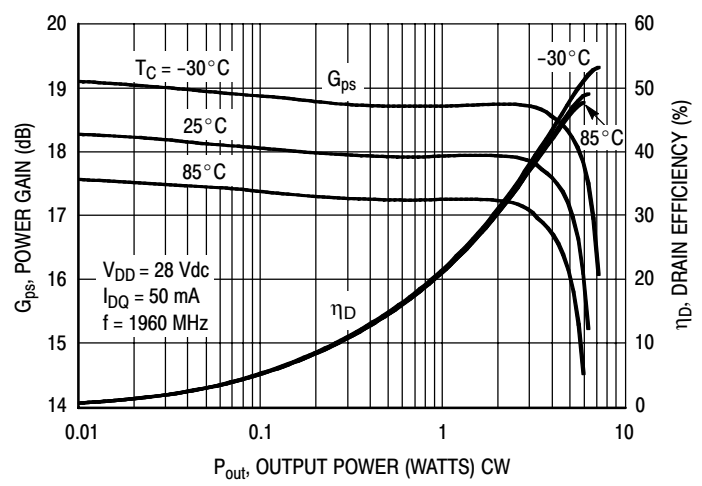

Figure 9. Power Gain and Drain Efficiency versus CW Output Power

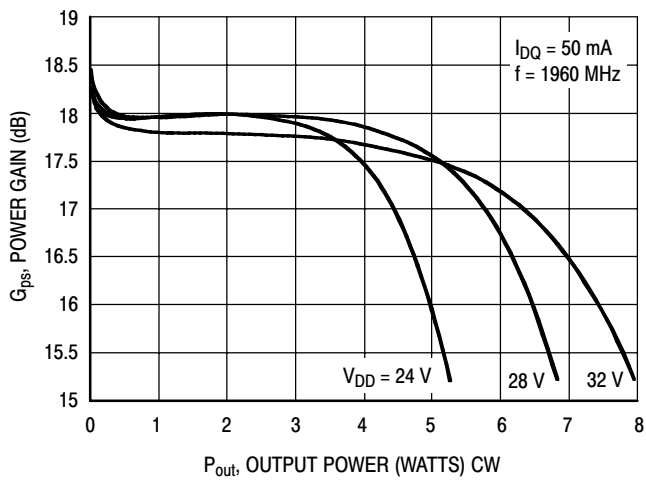

Figure 10. Power Gain versus Output Power

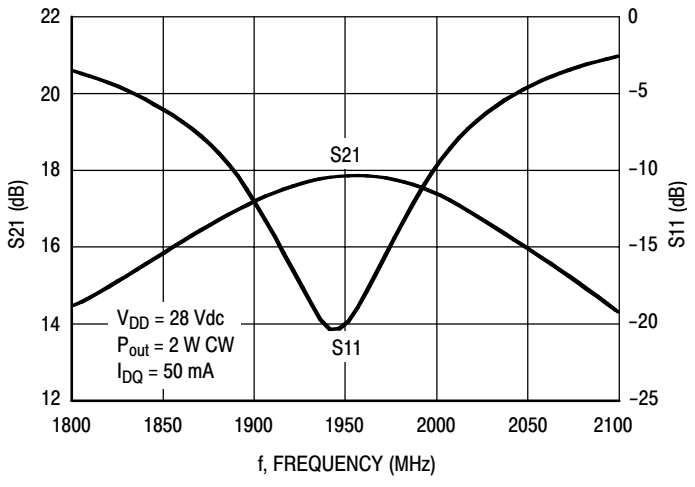
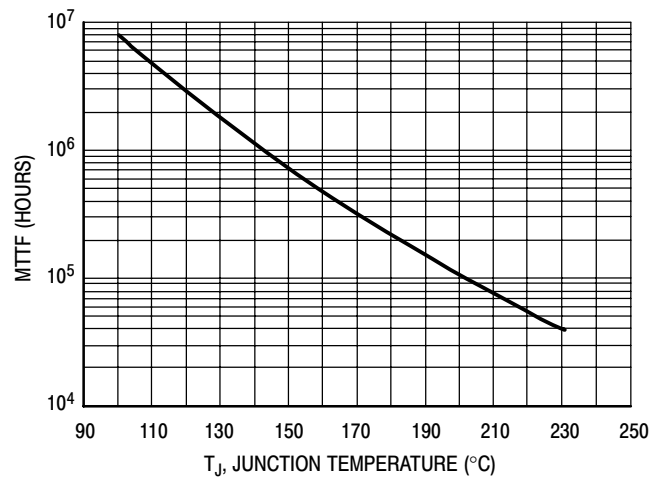

Figure 11. Broadband Frequency Response

TYPICAL CHARACTERISTICS



This above graph displays calculated MTTF in hours when the device is operated at $V_{DD} = 28$ Vdc, $P_{out} = 4$ W PEP, and $\eta_D = 33\%$.

MTTF calculator available at <http://www.freescale.com/rf>. Select Software & Tools/Development Tools/Calculators to access MTTF calculators by product.

Figure 12. MTTF versus Junction Temperature

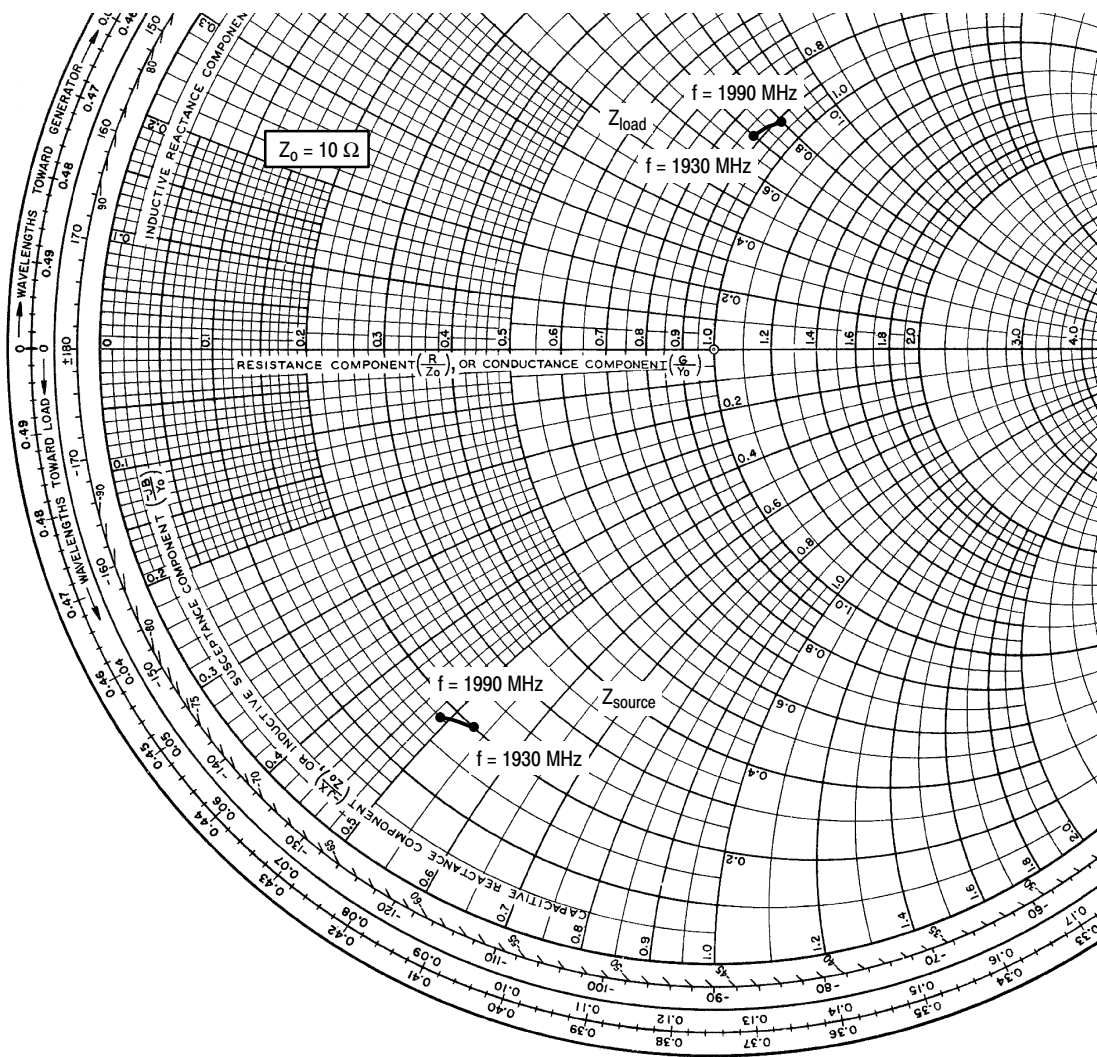

$V_{DD} = 28 \text{ Vdc}$, $I_{DQ} = 50 \text{ mA}$, $P_{out} = 4 \text{ W PEP}$

f MHz	Z _{source} Ω	Z _{load} Ω
1930	1.96 - j5.34	8.78 + j6.96
1960	1.89 - j5.10	8.93 + j7.46
1990	1.82 - j4.85	9.11 + j7.97

Z_{source} = Test circuit impedance as measured from gate to ground.

Z_{load} = Test circuit impedance as measured from drain to ground.

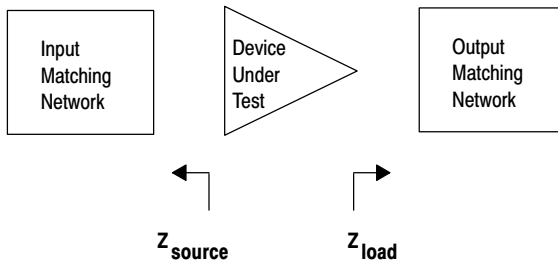

Figure 13. Series Equivalent Source and Load Impedance

Table 7. Common Source Scattering Parameters ($V_{DD} = 28\text{ V}$, 50 ohm system)

$I_{DQ} = 50\text{ mA}$

f MHz	S_{11}		S_{21}		S_{12}		S_{22}	
	$ S_{11} $	$\angle \phi$	$ S_{21} $	$\angle \phi$	$ S_{12} $	$\angle \phi$	$ S_{22} $	$\angle \phi$
500	0.649	-116.340	7.902	105.420	0.056	-73.750	0.548	-33.570
550	0.695	-121.680	7.502	98.790	0.053	-80.570	0.593	-41.480
600	0.733	-126.560	7.111	92.380	0.049	-87.010	0.632	-48.890
650	0.770	-131.340	6.699	86.290	0.045	-93.280	0.669	-56.000
700	0.800	-135.740	6.302	80.450	0.041	-99.120	0.701	-62.810
750	0.827	-140.030	5.922	74.850	0.038	-104.850	0.727	-69.290
800	0.848	-143.950	5.552	69.630	0.035	-110.110	0.750	-75.350
850	0.866	-147.690	5.220	64.580	0.032	-115.220	0.770	-81.130
900	0.882	-151.140	4.891	59.970	0.029	-119.960	0.786	-86.570
950	0.895	-154.560	4.597	55.490	0.026	-124.790	0.800	-91.730
1000	0.907	-157.590	4.315	51.240	0.024	-129.090	0.813	-96.660
1050	0.916	-160.540	4.060	47.170	0.022	-133.370	0.824	-101.340
1100	0.923	-163.310	3.819	43.340	0.020	-137.460	0.833	-105.790
1150	0.929	-165.930	3.601	39.650	0.018	-141.440	0.840	-110.050
1200	0.935	-168.430	3.398	36.110	0.017	-145.330	0.847	-114.170
1250	0.938	-170.770	3.210	32.740	0.015	-149.540	0.851	-118.060
1300	0.942	-173.030	3.036	29.490	0.014	-153.430	0.856	-121.880
1350	0.945	-175.140	2.875	26.360	0.013	-157.460	0.859	-125.520
1400	0.948	-177.170	2.728	23.330	0.012	-161.910	0.863	-129.020
1450	0.951	-179.090	2.590	20.440	0.011	-166.180	0.866	-132.390
1500	0.953	179.030	2.464	17.640	0.010	-170.630	0.869	-135.650
1550	0.954	177.270	2.347	14.920	0.009	-174.890	0.872	-138.760
1600	0.955	175.570	2.240	12.320	0.008	179.950	0.875	-141.750
1650	0.956	173.980	2.139	9.740	0.008	173.920	0.877	-144.650
1700	0.957	172.350	2.047	7.250	0.007	167.710	0.880	-147.480
1750	0.957	170.800	1.958	4.810	0.007	161.810	0.882	-150.180
1800	0.958	169.340	1.879	2.440	0.006	155.370	0.884	-152.760
1850	0.959	167.920	1.806	0.260	0.006	148.940	0.886	-155.230
1900	0.959	166.510	1.736	-1.980	0.005	142.630	0.887	-157.580
1950	0.960	165.200	1.668	-4.310	0.005	136.740	0.888	-160.050
2000	0.959	163.800	1.611	-6.240	0.005	129.910	0.890	-162.070
2050	0.959	162.420	1.555	-8.290	0.005	123.810	0.891	-164.190
2100	0.958	161.170	1.504	-10.270	0.005	118.200	0.892	-166.140
2150	0.958	159.840	1.456	-12.210	0.005	112.740	0.893	-168.060
2200	0.957	158.560	1.412	-14.130	0.005	108.460	0.894	-169.840
2250	0.957	157.160	1.372	-16.010	0.005	103.840	0.896	-171.610
2300	0.955	155.870	1.334	-17.870	0.005	99.310	0.896	-173.260
2350	0.954	154.510	1.300	-19.700	0.005	95.360	0.897	-174.830
2400	0.953	153.120	1.268	-21.510	0.005	91.030	0.898	-176.390
2450	0.953	151.730	1.238	-23.250	0.005	87.460	0.899	-177.840

Table 7. Common Source Scattering Parameters ($V_{DD} = 28\text{ V}$, 50 ohm system) (continued)

$I_{DQ} = 50\text{ mA}$

f MHz	S ₁₁		S ₂₁		S ₁₂		S ₂₂	
	S ₁₁	∠ φ	S ₂₁	∠ φ	S ₁₂	∠ φ	S ₂₂	∠ φ
2500	0.952	150.340	1.211	-25.120	0.006	84.160	0.899	-179.270
2550	0.950	149.010	1.187	-26.920	0.006	80.780	0.897	179.420
2600	0.949	147.380	1.166	-28.650	0.006	77.880	0.897	178.120
2650	0.948	145.920	1.144	-30.420	0.007	74.670	0.898	176.840
2700	0.944	144.200	1.121	-32.310	0.007	71.360	0.896	175.480
2750	0.944	142.790	1.105	-34.230	0.007	67.980	0.897	174.060
2800	0.943	141.020	1.088	-36.000	0.007	63.950	0.897	172.930
2850	0.941	139.410	1.073	-37.870	0.007	61.230	0.896	171.630
2900	0.940	137.640	1.058	-39.760	0.008	59.810	0.896	170.330
2950	0.938	135.900	1.045	-41.680	0.008	58.280	0.896	169.040
3000	0.937	133.860	1.032	-43.610	0.008	56.740	0.895	167.510

PACKAGE DIMENSIONS

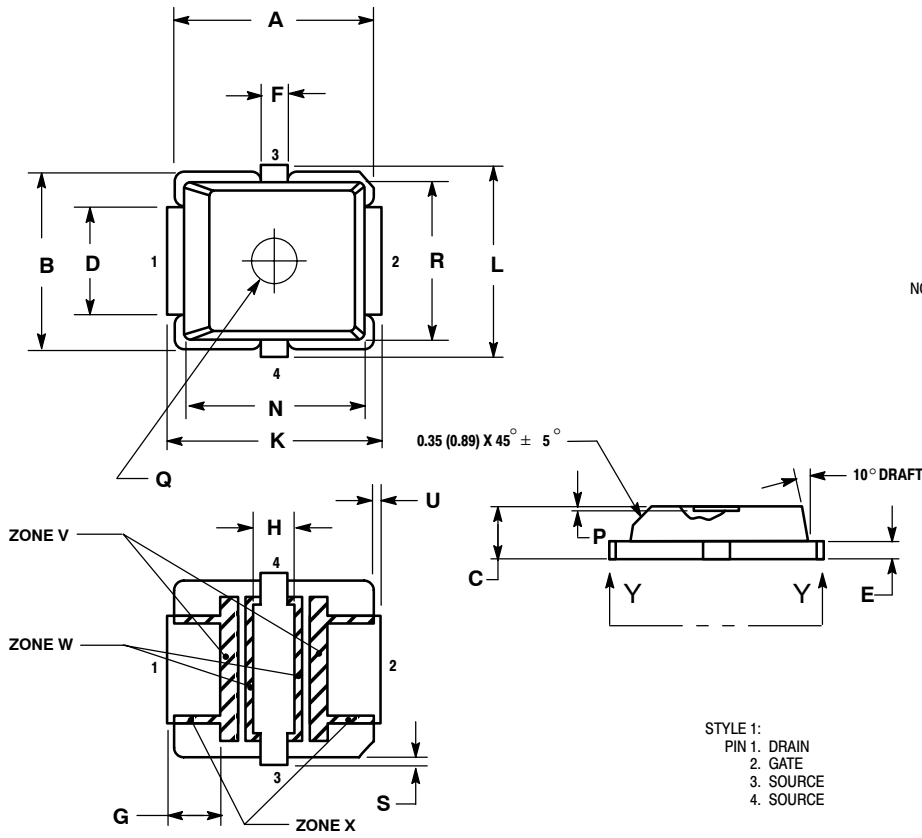

NOTES:

1. INTERPRET DIMENSIONS AND TOLERANCES PER ASME Y14.5M, 1984.
2. CONTROLLING DIMENSION: INCH
3. RESIN BLEED/FLASH ALLOWABLE IN ZONE V, W, AND X.

DIM	INCHES		MILLIMETERS	
	MIN	MAX	MIN	MAX
A	0.255	0.265	6.48	6.73
B	0.225	0.235	5.72	5.97
C	0.065	0.072	1.65	1.83
D	0.130	0.150	3.30	3.81
E	0.021	0.026	0.53	0.66
F	0.026	0.044	0.66	1.12
G	0.050	0.070	1.27	1.78
H	0.045	0.063	1.14	1.60
J	0.160	0.180	4.06	4.57
K	0.273	0.285	6.93	7.24
L	0.245	0.255	6.22	6.48
N	0.230	0.240	5.84	6.10
P	0.000	0.008	0.00	0.20
Q	0.055	0.063	1.40	1.60
R	0.200	0.210	5.08	5.33
S	0.006	0.012	0.15	0.31
U	0.006	0.012	0.15	0.31
ZONE V	0.000	0.021	0.00	0.53
ZONE W	0.000	0.010	0.00	0.25
ZONE X	0.000	0.010	0.00	0.25

VIEW Y-Y

**CASE 466-03
 ISSUE D
 PLD 1.5
 PLASTIC**

Refer to the following documents to aid your design process.

Application Notes

- AN1955: Thermal Measurement Methodology of RF Power Amplifiers

Engineering Bulletins

- EB212: Using Data Sheet Impedances for RF LDMOS Devices

Software

- Electromigration MTTF Calculator
- RF High Power Model

For Software and Tools, do a Part Number search at <http://www.freescale.com>, and select the “Part Number” link. Go to the Software & Tools tab on the part’s Product Summary page to download the respective tool.

REVISION HISTORY

The following table summarizes revisions to this document.

Revision	Date	Description
2	Feb. 2007	<ul style="list-style-type: none"> • Corrected MSL Rating from 3 to 1 in Table 4, Moisture Sensitivity Level, p. 2 • Updated $V_{GS(th)}$ and $V_{GS(Q)}$ to reflect tighter HV6 windows and added Fixture Gate Quiescent $V_{GG(Q)}$ to On Characteristics table to account for test fixture resistor divider network, p. 2 • Updated Part Numbers in Table 6, Component Designations and Values, to RoHS compliant part numbers, p. 3 • Removed lower voltage tests from Fig. 10, Power Gain versus Output Power, due to fixed tuned fixture limitations, p. 6 • Replaced Figure 12, MTTF versus Junction Temperature with updated graph. Removed Amps² and listed operating characteristics and location of MTTF calculator for device, p. 7 • Added Product Documentation and Revision History section, p. 12
3	Apr. 2009	<ul style="list-style-type: none"> • Corrected ESD structures to reflect current testing results. Changed HBM from 1A to 1C and CDM from III to IV, p. 1 • Corrected C_{iss} test condition to indicate AC stimulus on the V_{GS} connection versus the V_{DS} connection, Dynamic Characteristics table, p. 2 • Updated PCB information to show more specific material details, Fig. 1, Test Circuit Schematic, p. 3 • Updated Part Numbers in Table 6, Component Designations and Values, to latest RoHS compliant part numbers, p. 3
4	June 2009	<ul style="list-style-type: none"> • Modified data sheet to reflect MSL rating change from 1 to 3 as a result of the standardization of packing process as described in Product and Process Change Notification number, PCN13516, p. 2 • Added Electromigration MTTF Calculator and RF High Power Model availability to Product Documentation, Tools and Software, p. 12

How to Reach Us:

Home Page:

www.freescale.com

Web Support:

<http://www.freescale.com/support>

USA/Europe or Locations Not Listed:

Freescale Semiconductor, Inc.
Technical Information Center, EL516
2100 East Elliot Road
Tempe, Arizona 85284
1-800-521-6274 or +1-480-768-2130
www.freescale.com/support

Europe, Middle East, and Africa:

Freescale Halbleiter Deutschland GmbH
Technical Information Center
Schatzbogen 7
81829 Muenchen, Germany
+44 1296 380 456 (English)
+46 8 52200080 (English)
+49 89 92103 559 (German)
+33 1 69 35 48 48 (French)
www.freescale.com/support

Japan:

Freescale Semiconductor Japan Ltd.
Headquarters
ARCO Tower 15F
1-8-1, Shimo-Meguro, Meguro-ku,
Tokyo 153-0064
Japan
0120 191014 or +81 3 5437 9125
support.japan@freescale.com

Asia/Pacific:

Freescale Semiconductor China Ltd.
Exchange Building 23F
No. 118 Jianguo Road
Chaoyang District
Beijing 100022
China
+86 10 5879 8000
support.asia@freescale.com

For Literature Requests Only:

Freescale Semiconductor Literature Distribution Center
1-800-441-2447 or +1-303-675-2140
Fax: +1-303-675-2150
LDCForFreescaleSemiconductor@hibbertgroup.com

Information in this document is provided solely to enable system and software implementers to use Freescale Semiconductor products. There are no express or implied copyright licenses granted hereunder to design or fabricate any integrated circuits or integrated circuits based on the information in this document.

Freescale Semiconductor reserves the right to make changes without further notice to any products herein. Freescale Semiconductor makes no warranty, representation or guarantee regarding the suitability of its products for any particular purpose, nor does Freescale Semiconductor assume any liability arising out of the application or use of any product or circuit, and specifically disclaims any and all liability, including without limitation consequential or incidental damages. "Typical" parameters that may be provided in Freescale Semiconductor data sheets and/or specifications can and do vary in different applications and actual performance may vary over time. All operating parameters, including "Typicals", must be validated for each customer application by customer's technical experts. Freescale Semiconductor does not convey any license under its patent rights nor the rights of others. Freescale Semiconductor products are not designed, intended, or authorized for use as components in systems intended for surgical implant into the body, or other applications intended to support or sustain life, or for any other application in which the failure of the Freescale Semiconductor product could create a situation where personal injury or death may occur. Should Buyer purchase or use Freescale Semiconductor products for any such unintended or unauthorized application, Buyer shall indemnify and hold Freescale Semiconductor and its officers, employees, subsidiaries, affiliates, and distributors harmless against all claims, costs, damages, and expenses, and reasonable attorney fees arising out of, directly or indirectly, any claim of personal injury or death associated with such unintended or unauthorized use, even if such claim alleges that Freescale Semiconductor was negligent regarding the design or manufacture of the part.

Freescale™ and the Freescale logo are trademarks of Freescale Semiconductor, Inc. All other product or service names are the property of their respective owners.

© Freescale Semiconductor, Inc. 2007, 2009. All rights reserved.

Mouser Electronics

Authorized Distributor

Click to View Pricing, Inventory, Delivery & Lifecycle Information:

[Freescale Semiconductor:](#)

[MW6S004NT1](#)