



# FH102A

## RF Transistor 10V, 70mA, $f_T=7\text{GHz}$ NPN Dual MCP6

ON Semiconductor®

<http://onsemi.com>

### Features

- Composite type with 2 transistors contained in the MCP package currently in use, improving the mounting efficiency greatly
- The FH102A is formed with two chips, being equivalent to the 2SC5226A, placed in one package
- Optimal for differential amplification due to excellent thermal equilibrium and pair capability

### Specifications

#### Absolute Maximum Ratings at $T_a=25^\circ\text{C}$

Parameter	Symbol	Conditions	Ratings	Unit
Collector-to-Base Voltage	$V_{CBO}$		20	V
Collector-to-Emitter Voltage	$V_{CEO}$		10	V
Emitter-to-Base Voltage	$V_{EBO}$		2	V
Collector Current	$I_C$		70	mA
Collector Dissipation	$P_C$	When mounted on ceramic substrate (250mm <sup>2</sup> ×0.8mm) 1unit	300	mW
Total Power Dissipation	$P_T$	When mounted on ceramic substrate (250mm <sup>2</sup> ×0.8mm)	500	mW
Junction Temperature	$T_j$		150	$^\circ\text{C}$
Storage Temperature	$T_{stg}$		-55 to +150	$^\circ\text{C}$

Stresses exceeding Maximum Ratings may damage the device. Maximum Ratings are stress ratings only. Functional operation above the Recommended Operating Conditions is not implied. Extended exposure to stresses above the Recommended Operating Conditions may affect device reliability.

### Package Dimensions

unit : mm (typ)

7026A-002

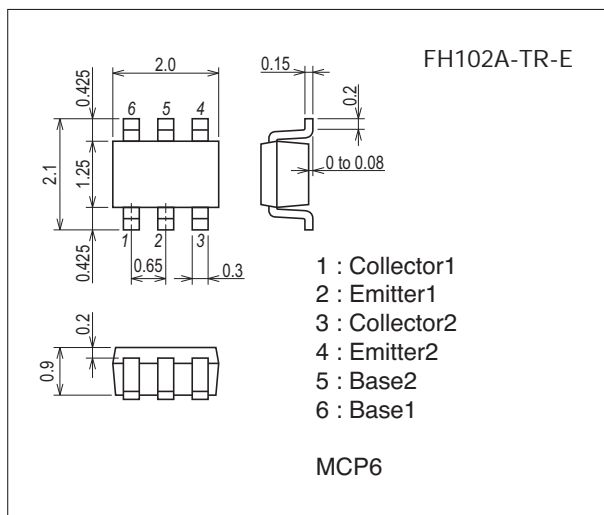

### Product & Package Information

- Package : MCP6
- JEITA, JEDEC : SC-88, SC-70-6, SOT-363
- Minimum Packing Quantity : 3,000 pcs./reel

### Packing Type : TR

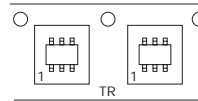

### Marking

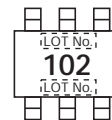

### Electrical Connection

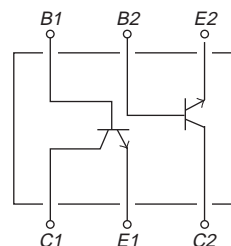

# FH102A

## Electrical Characteristics at Ta=25°C

Parameter	Symbol	Conditions	Ratings			Unit
			min	typ	max	
Collector Cutoff Current	ICBO	V <sub>CB</sub> =10V, I <sub>E</sub> =0A			1.0	μA
Emitter Cutoff Current	IEBO	V <sub>EB</sub> =1V, I <sub>C</sub> =0A			10	μA
DC Current Gain	h <sub>FE</sub>	V <sub>CE</sub> =5V, I <sub>C</sub> =20mA	90		200	
DC Current Gain Ratio	h <sub>FE</sub> (small/large)	V <sub>CE</sub> =5V, I <sub>C</sub> =20mA	0.7	0.95		
Base-to-Emitter Voltage Difference	V <sub>BE</sub> (large-small)	V <sub>CE</sub> =5V, I <sub>C</sub> =20mA		10		mV
Gain-Bandwidth Product	f <sub>T</sub>	V <sub>CE</sub> =5V, I <sub>C</sub> =20mA	5	7		GHz
Output Capacitance	C <sub>ob</sub>	V <sub>CB</sub> =10V, f=1MHz		0.75	1.2	pF
Reverse Transfer Capacitance	C <sub>re</sub>	V <sub>CB</sub> =10V, f=1MHz		0.5		pF
Forward Transfer Gain	S <sub>21e</sub>   <sup>2</sup> <sub>1</sub>	V <sub>CE</sub> =5V, I <sub>C</sub> =20mA, f=1GHz	9	12		dB
	S <sub>21e</sub>   <sup>2</sup> <sub>2</sub>	V <sub>CE</sub> =2V, I <sub>C</sub> =3mA, f=1GHz		8		dB
Noise Figure	NF	V <sub>CE</sub> =5V, I <sub>C</sub> =7mA, f=1GHz		1.0	1.8	dB

Note) The specifications shown above are for each individual transistor except the h<sub>FE</sub>(small/large) and V<sub>BE</sub> (large-small) for which pair capability is also shown.

## Ordering Information

Device	Package	Shipping	memo
FH102A-TR-E	MCP6	3,000pcs./reel	Pb Free

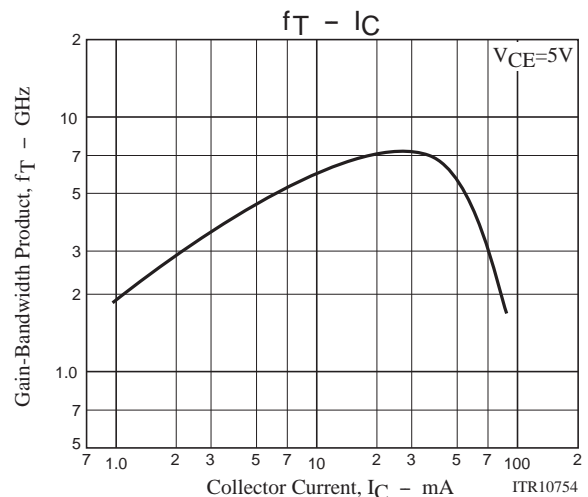
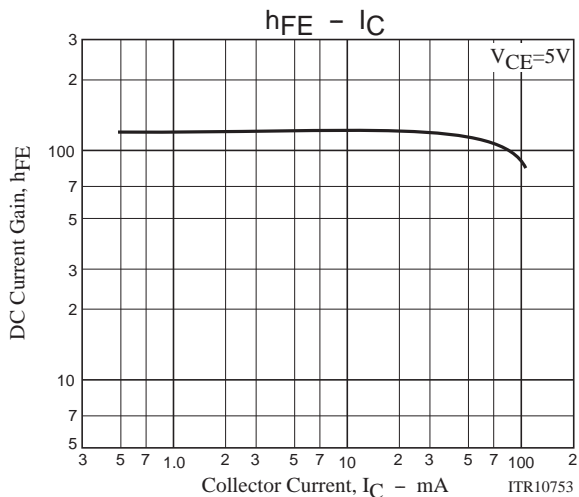

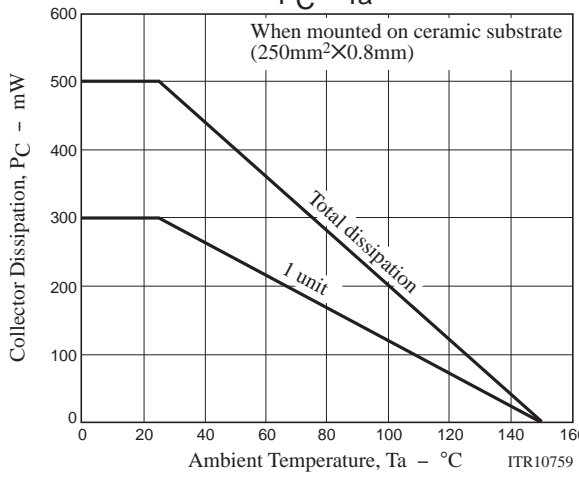
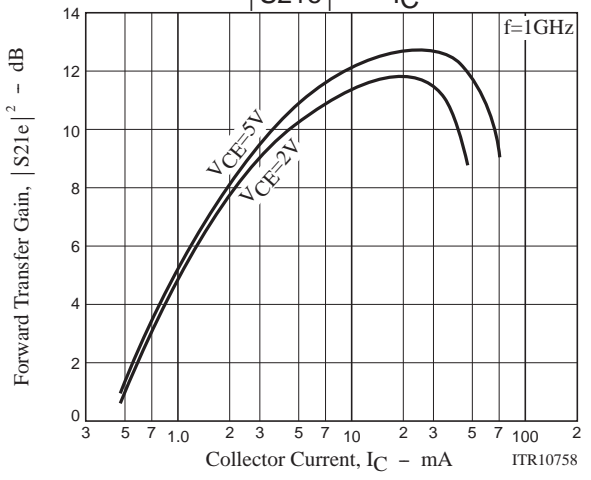
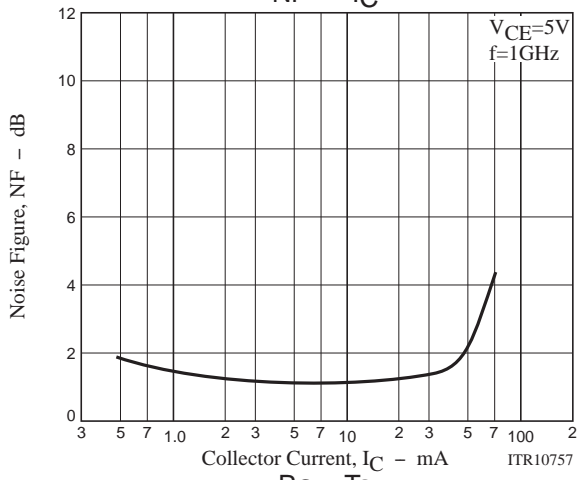
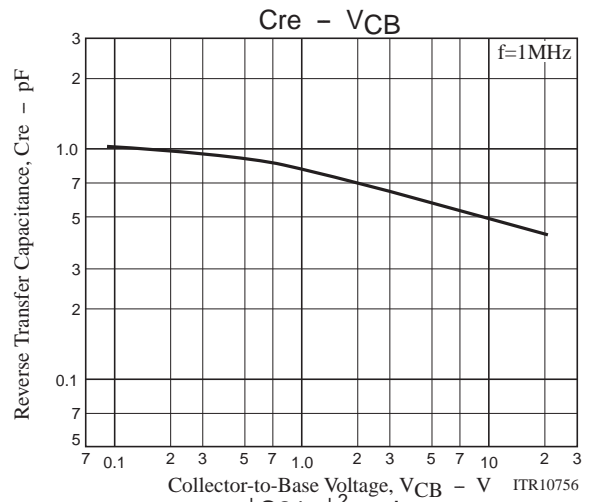
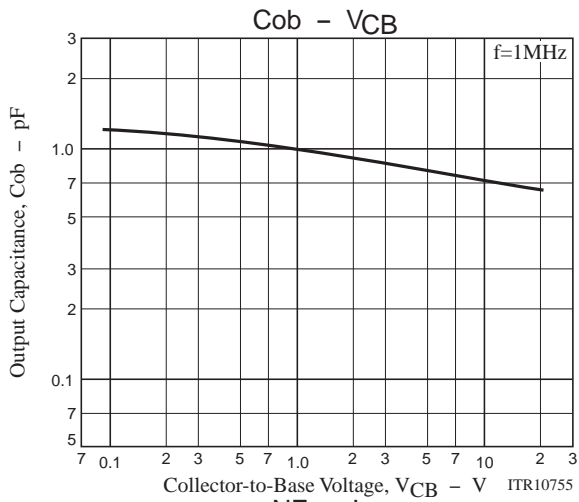

S Parameter

f=100MHz, 200 to 2000MHz(200MHz Step)

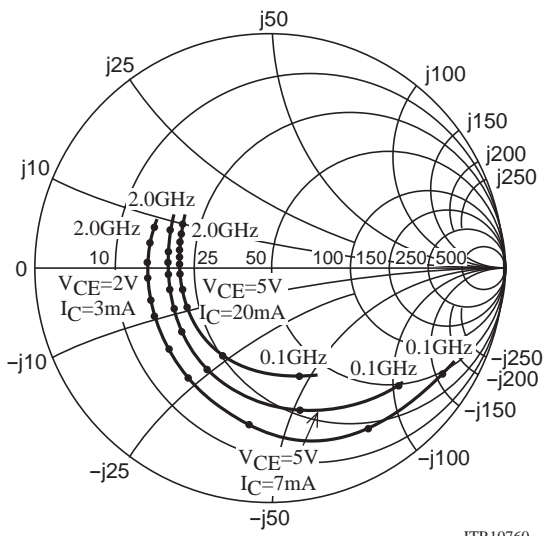

ITR10760

f=100MHz, 200 to 2000MHz(200MHz Step)

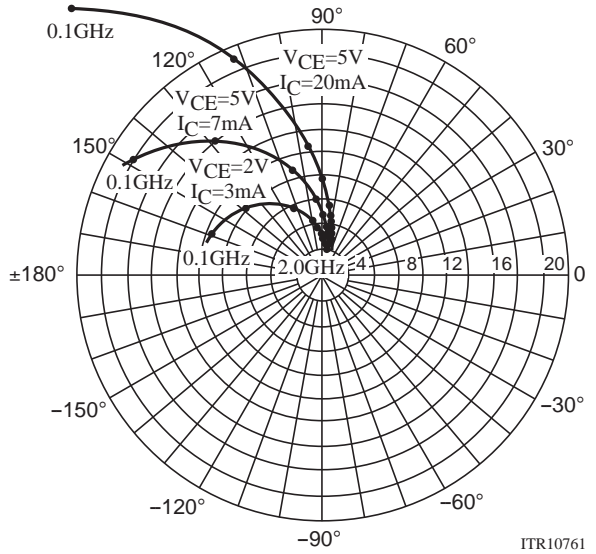

ITR10761

f=100MHz, 200 to 2000MHz(200MHz Step)

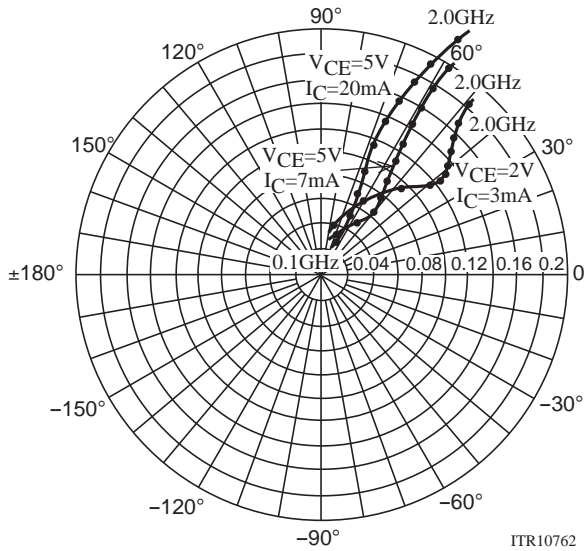

ITR10762

f=100MHz, 200 to 2000MHz(200MHz Step)

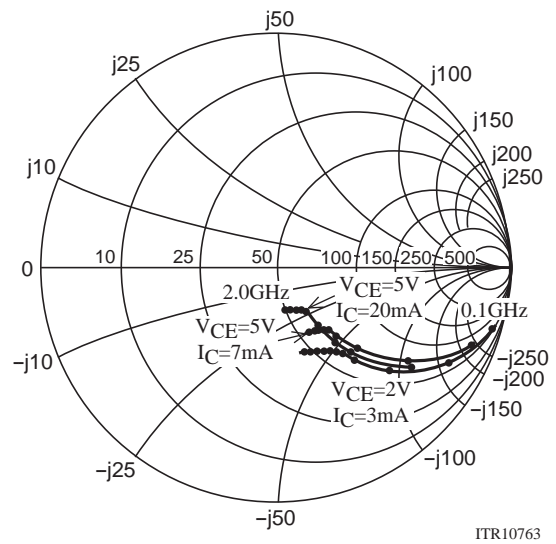

ITR10763

## FH102A

### S Parameters (Common emitter)

$V_{CE}=5V, I_C=7mA, Z_O=50\Omega$

Freq(MHz)	S11	$\angle S11$	S21	$\angle S21$	S12	$\angle S12$	S22	$\angle S22$
100	0.720	-46.0	17.973	148.5	0.030	68.5	0.880	-23.6
200	0.612	-80.9	13.927	127.3	0.047	57.1	0.697	-37.6
400	0.497	-121.3	8.656	105.0	0.066	51.3	0.479	-47.6
600	0.456	-143.5	6.080	92.8	0.079	52.9	0.382	-50.5
800	0.440	-157.6	4.725	84.3	0.094	55.4	0.339	-51.8
1000	0.436	-167.5	3.864	77.0	0.110	56.8	0.323	-53.4
1200	0.434	-176.1	3.258	70.3	0.126	57.9	0.312	-55.8
1400	0.433	176.6	2.847	64.5	0.143	58.4	0.304	-58.3
1600	0.433	170.9	2.329	57.4	0.160	58.9	0.296	-62.0
1800	0.434	165.0	2.252	54.2	0.178	58.6	0.293	-65.0
2000	0.439	159.6	2.057	49.2	0.197	58.1	0.294	-68.1

$V_{CE}=5V, I_C=20mA, Z_O=50\Omega$

Freq(MHz)	S11	$\angle S11$	S21	$\angle S21$	S12	$\angle S12$	S22	$\angle S22$
100	0.481	-78.8	29.795	132.9	0.022	63.9	0.707	-38.2
200	0.420	-119.2	19.008	112.2	0.033	60.8	0.470	-51.1
400	0.391	-151.6	10.416	95.4	0.052	64.7	0.296	-55.3
600	0.386	-166.4	7.084	86.6	0.071	67.2	0.236	-56.1
800	0.381	-175.9	5.407	80.1	0.092	68.4	0.213	-56.6
1000	0.382	178.2	4.401	74.1	0.114	67.8	0.208	-57.9
1200	0.385	172.1	3.701	68.5	0.134	66.8	0.204	-60.7
1400	0.388	166.7	3.217	63.6	0.156	65.6	0.202	-63.5
1600	0.390	162.1	2.839	58.8	0.176	64.0	0.199	-67.9
1800	0.391	156.7	2.534	54.3	0.197	62.4	0.197	-71.2
2000	0.394	152.1	2.319	50.1	0.219	60.6	0.197	-74.2

$V_{CE}=2V, I_C=3mA, Z_O=50\Omega$

Freq(MHz)	S11	$\angle S11$	S21	$\angle S21$	S12	$\angle S12$	S22	$\angle S22$
100	0.858	-32.4	9.413	157.2	0.040	72.6	0.945	-16.5
200	0.782	-60.7	8.187	138.5	0.070	59.2	0.833	-29.3
400	0.653	-101.1	5.855	113.8	0.101	44.5	0.637	-43.2
600	0.588	-126.5	4.337	98.4	0.114	39.1	0.515	-50.0
800	0.557	-143.7	3.444	87.7	0.122	38.0	0.454	-53.8
1000	0.543	-156.3	2.871	78.5	0.130	38.6	0.426	-57.1
1200	0.536	-166.8	2.446	70.5	0.137	40.3	0.407	-60.3
1400	0.533	-175.5	2.145	63.5	0.146	42.5	0.393	-63.8
1600	0.527	177.0	1.904	57.1	0.155	45.0	0.382	-68.0
1800	0.525	170.3	1.714	51.7	0.168	47.3	0.379	-72.0
2000	0.528	163.8	1.564	45.9	0.183	49.2	0.378	-75.8

Embossed Taping Specification

FH102A-TR-E

Storage package Outline name	Carrier tape Type number	Maximum Number of devices contained (pcs.)			Packing format	
		Reel	Inner box	Outer box	Inner box BOX (C-1)	Outer box BOX (A-7)
MCP 6	MCP 6	3,000	15,000	90,000	5 reels contained Dimensions:mm(external) 1 8 3 × 7 2 × 1 8 5	6 inner boxes contained Dimensions:mm(external) 4 4 0 × 1 9 5 × 2 1 0

1. Packing format

Packing method

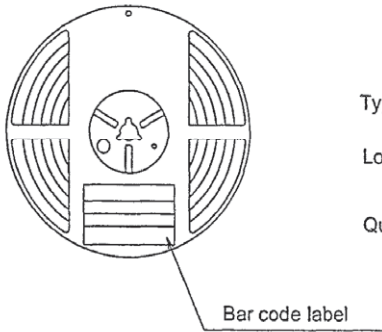

Bar code label

(Unit : mm)

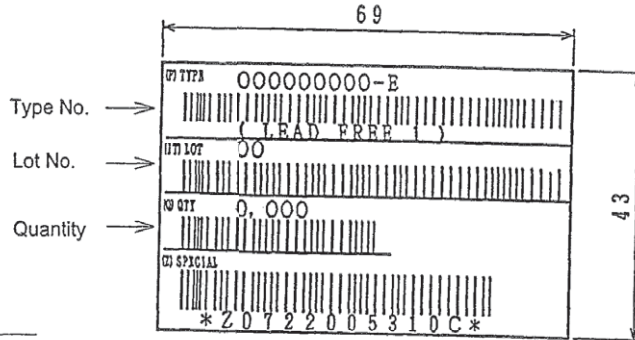

\* LEAD FREE 1 :  
Lead-free external terminal surface treatment product.

2. Taping structure

2-1. Carrier tape size (Unit : mm)

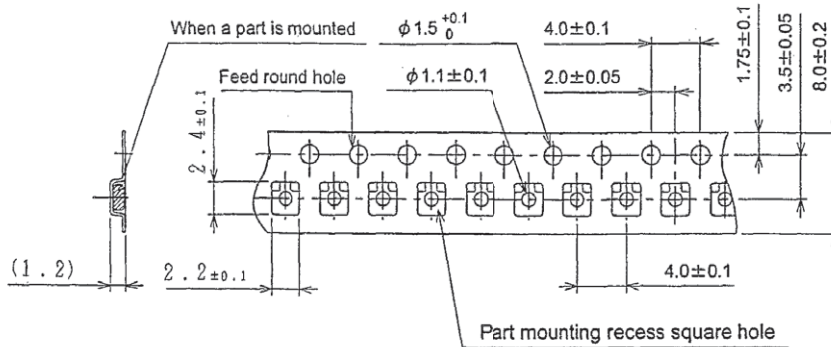

2-2. Parts placement direction

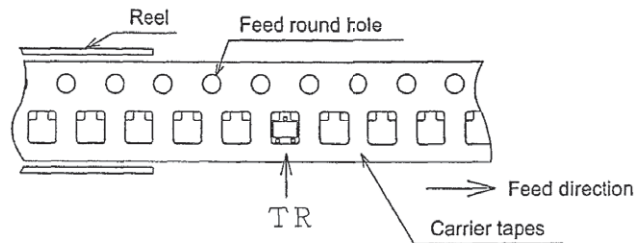

Those with 1 electrode pin on the feed hole side . . . . TR

# FH102A

## Outline Drawing

FH102A-TR-E

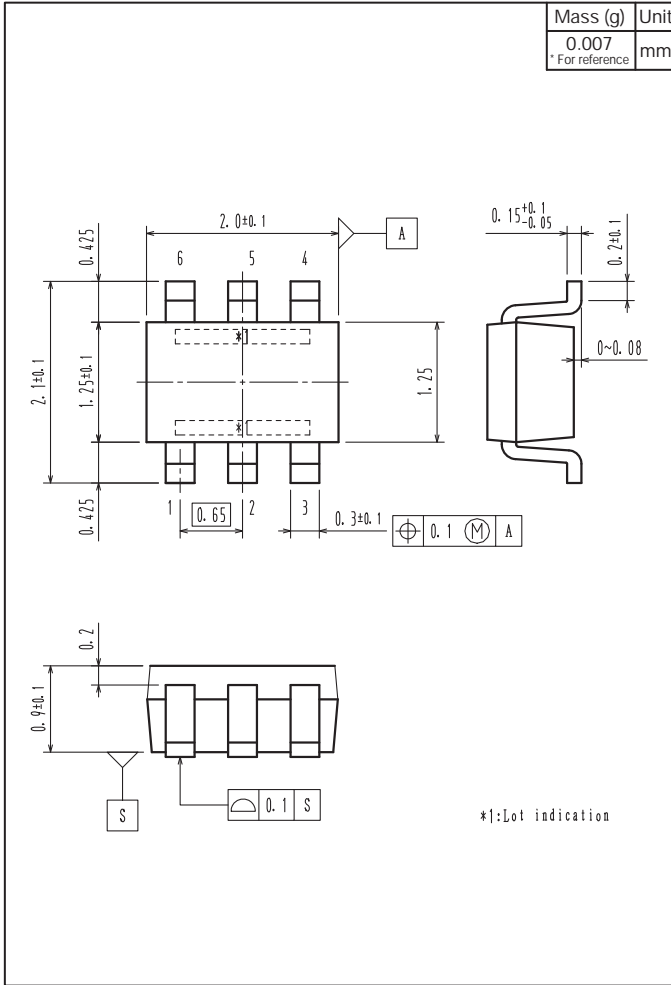

## Land Pattern Example

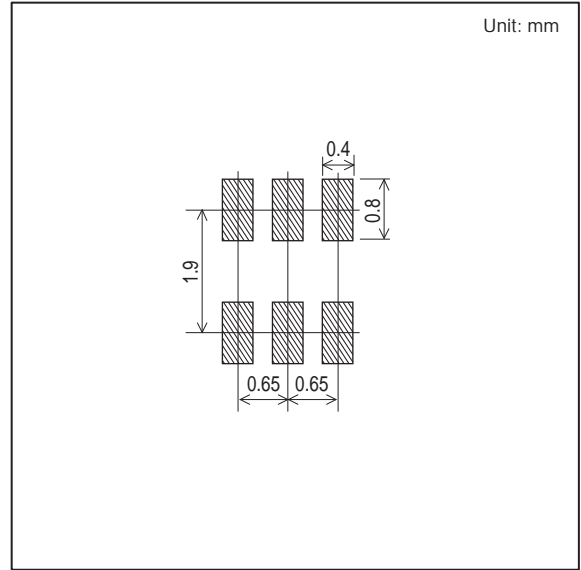

ON Semiconductor and the ON logo are registered trademarks of Semiconductor Components Industries, LLC (SCILLC). SCILLC owns the rights to a number of patents, trademarks, copyrights, trade secrets, and other intellectual property. A listing of SCILLC's product/patent coverage may be accessed at [www.onsemi.com/site/pdf/Patent-Marking.pdf](http://www.onsemi.com/site/pdf/Patent-Marking.pdf). SCILLC reserves the right to make changes without further notice to any products herein. SCILLC makes no warranty, representation or guarantee regarding the suitability of its products for any particular purpose, nor does SCILLC assume any liability arising out of the application or use of any product or circuit, and specifically disclaims any and all liability, including without limitation special, consequential or incidental damages. "Typical" parameters which may be provided in SCILLC data sheets and/or specifications can and do vary in different applications and actual performance may vary over time. All operating parameters, including "Typicals" must be validated for each customer application by customer's technical experts. SCILLC does not convey any license under its patent rights nor the rights of others. SCILLC products are not designed, intended, or authorized for use as components in systems intended for surgical implant into the body, or other applications intended to support or sustain life, or for any other application in which the failure of the SCILLC product could create a situation where personal injury or death may occur. Should Buyer purchase or use SCILLC products for any such unintended or unauthorized application, Buyer shall indemnify and hold SCILLC and its officers, employees, subsidiaries, affiliates, and distributors harmless against all claims, costs, damages, and expenses, and reasonable attorney fees arising out of, directly or indirectly, any claim of personal injury or death associated with such unintended or unauthorized use, even if such claim alleges that SCILLC was negligent regarding the design or manufacture of the part. SCILLC is an Equal Opportunity/Affirmative Action Employer. This literature is subject to all applicable copyright laws and is not for resale in any manner.



# Mouser Electronics

Authorized Distributor

Click to View Pricing, Inventory, Delivery & Lifecycle Information:

[ON Semiconductor:](#)

[FH102A-TR-E](#)