

# MBRS2H100T3G, NBR2H100T3G, MBRA2H100T3G, NRVBA2H100T3G,



**ON Semiconductor®**

<http://onsemi.com>

## Surface Mount Schottky Power Rectifier SMA/SMB Power Surface Mount Package

This device employs the Schottky Barrier principle in a metal-to-silicon power rectifier. Features epitaxial construction with oxide passivation and metal overlay contact. Ideally suited for low voltage, high frequency switching power supplies; free wheeling diodes and polarity protection diodes.

### Features

- Compact Package with J-Bend Leads Ideal for Automated Handling
- Highly Stable Oxide Passivated Junction
- Guard-Ring for Overvoltage Protection
- Low Forward Voltage Drop
- NBR and NRVB Prefixes for Automotive and Other Applications Requiring Unique Site and Control Change Requirements; AEC-Q101 Qualified and PPAP Capable
- These Devices are Pb-Free and are RoHS Compliant\*

### Mechanical Characteristics

- Case: Molded Epoxy
- Epoxy Meets UL 94 V-0 @ 0.125 in
- Weight: 70 mg (SMA), 95 mg (SMB) (Approximately)
- Cathode Polarity Band
- Lead and Mounting Surface Temperature for Soldering Purposes: 260°C Max. for 10 Seconds
- Finish: All External Surfaces Corrosion Resistant and Terminal Leads are Readily Solderable
- ESD Ratings:
  - ♦ Machine Model = C
  - ♦ Human Body Model = 3B
- Device Meets MSL1 Requirements

## SCHOTTKY BARRIER RECTIFIER 2.0 AMPERES, 100 VOLTS

### MARKING DIAGRAMS



**SMA  
CASE 403D**

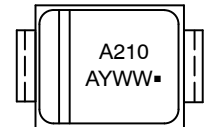

**SMB  
CASE 403A**

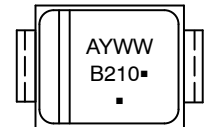

- A210 = MBRA2H100T3G  
NRVBA2H100T3G
- B210 = MBRS2H100T3G  
NBR2H100T3G
- A = Assembly Location
- Y = Year
- WW = Work Week
- = Pb-Free Package

(Note: Microdot may be in either location)

### ORDERING INFORMATION

Device	Package	Shipping†
MBRA2H100T3G	SMA (Pb-Free)	5,000 / Tape & Reel
NRVBA2H100T3G	SMA (Pb-Free)	5,000 / Tape & Reel
MBRS2H100T3G	SMB (Pb-Free)	2,500 / Tape & Reel
NBR2H100T3G	SMB (Pb-Free)	2,500 / Tape & Reel

†For information on tape and reel specifications, including part orientation and tape sizes, please refer to our Tape and Reel Packaging Specifications Brochure, BRD8011/D.

\*For additional information on our Pb-Free strategy and soldering details, please download the ON Semiconductor Soldering and Mounting Techniques Reference Manual, SOLDERRM/D.

# MBRS2H100T3G, NBR2H100T3G, MBRA2H100T3G, NRVBA2H100T3G,

## MAXIMUM RATINGS

Rating	Symbol	Value	Unit
Peak Repetitive Reverse Voltage Working Peak Reverse Voltage DC Blocking Voltage	$V_{RRM}$ $V_{RWM}$ $V_R$	100	V
Average Rectified Forward Current ( $T_L = 150^\circ\text{C}$ )	$I_O$	2.0	A
Non-Repetitive Peak Surge Current (Surge Applied at Rated Load Conditions Halfwave, Single Phase, 60 Hz)	$I_{FSM}$	130	A
Storage Temperature Range	$T_{stg}$	-65 to +175	$^\circ\text{C}$
Operating Junction Temperature (Note 1)	$T_J$	-65 to +175	$^\circ\text{C}$

Stresses exceeding Maximum Ratings may damage the device. Maximum Ratings are stress ratings only. Functional operation above the Recommended Operating Conditions is not implied. Extended exposure to stresses above the Recommended Operating Conditions may affect device reliability.

1. The heat generated must be less than the thermal conductivity from Junction-to-Ambient:  $dP_D/dT_J < 1/R_{\theta JA}$ .

## THERMAL CHARACTERISTICS

Characteristic	Symbol	Value	Unit
Thermal Resistance, Junction-to-Lead (Note 2) MBRA2H100T3G, NRVBA2H100T3G MBRS2H100T3G, NBR2H100T3G	$\Psi_{JCL}$	14 12	$^\circ\text{C}/\text{W}$
Thermal Resistance, Junction-to-Ambient (Note 2) MBRA2H100T3G, NRVBA2H100T3G MBRS2H100T3G, NBR2H100T3G	$R_{\theta JA}$	75 71	$^\circ\text{C}/\text{W}$
Thermal Resistance, Junction-to-Ambient (Note 3) MBRA2H100T3G, NRVBA2H100T3G MBRS2H100T3G, NBR2H100T3G	$R_{\theta JA}$	275 230	$^\circ\text{C}/\text{W}$

2. Mounted with 700 mm square copper pad size (Approximately 1 inch square) 1 oz FR4 Board.

3. Mounted with minimum recommended pad size 1 oz FR4 Board.

## ELECTRICAL CHARACTERISTICS

Characteristic	Symbol	Value		Unit
		$T_J = 25^\circ\text{C}$	$T_J = 125^\circ\text{C}$	
Maximum Instantaneous Forward Voltage (Note 4) ( $I_F = 2.0\text{ A}$ )	$V_F$	0.79	0.65	V
Maximum Instantaneous Reverse Current (Note 4) ( $V_R = 100\text{ V}$ )	$I_R$	0.008	1.5	mA

4. Pulse Test: Pulse Width  $\leq 380\ \mu\text{s}$ , Duty Cycle  $\leq 2.0\%$ .

# MBRS2H100T3G, NBRS2H100T3G, MBRA2H100T3G, NRVBA2H100T3G,

## TYPICAL CHARACTERISTICS

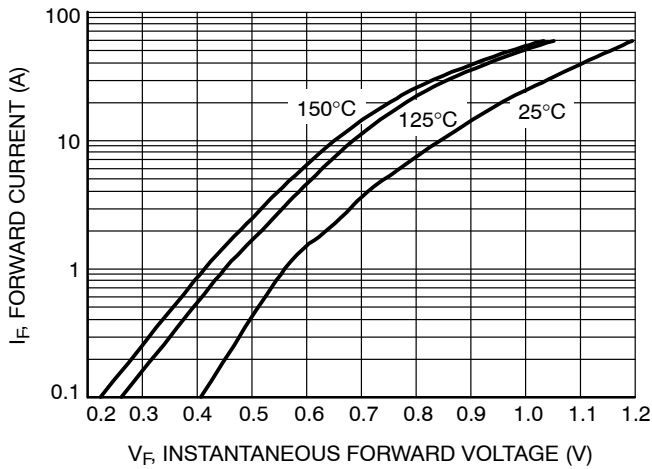

Figure 1. Typical Forward Voltage

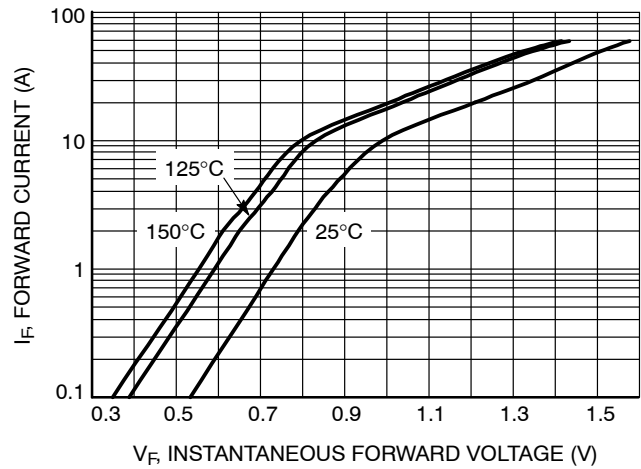

Figure 2. Maximum Forward Voltage

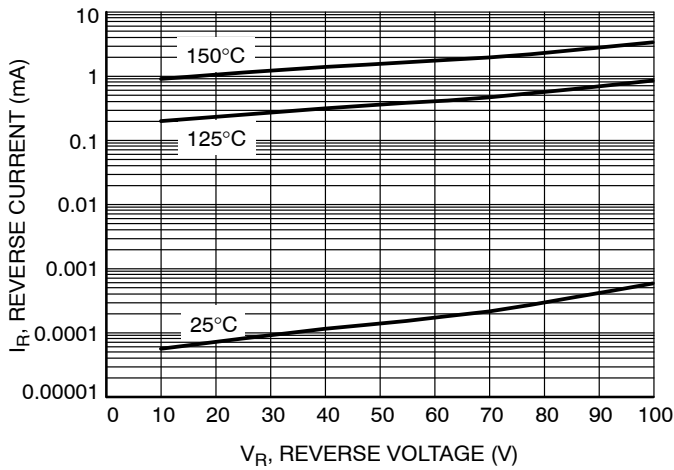

Figure 3. Typical Reverse Current

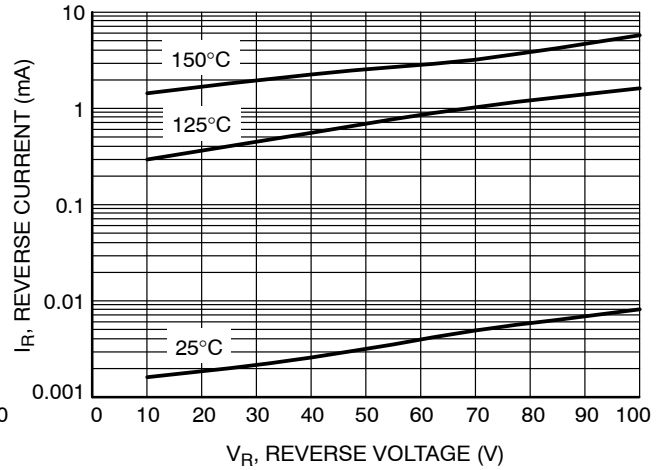

Figure 4. Maximum Reverse Current

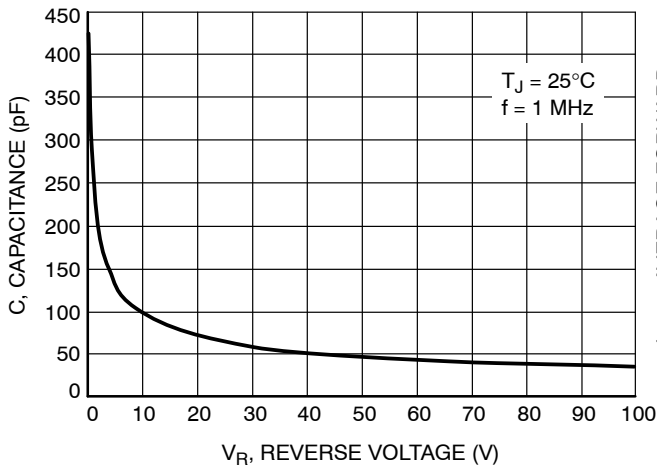

Figure 5. Typical Capacitance

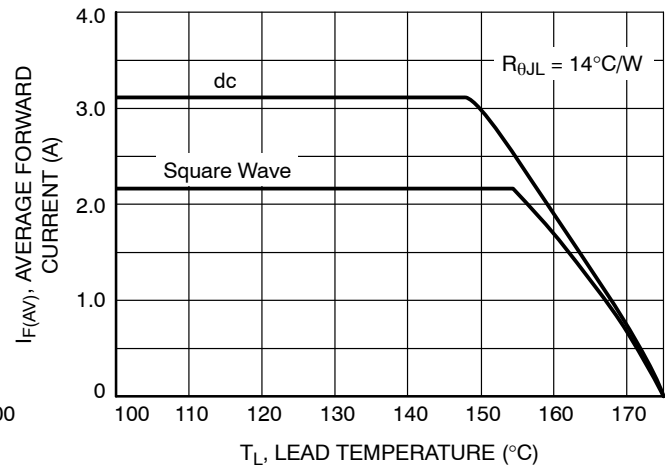

Figure 6. Current Derating – Lead

# MBRS2H100T3G, NBR2H100T3G, MBRA2H100T3G, NRVBA2H100T3G,

## TYPICAL CHARACTERISTICS

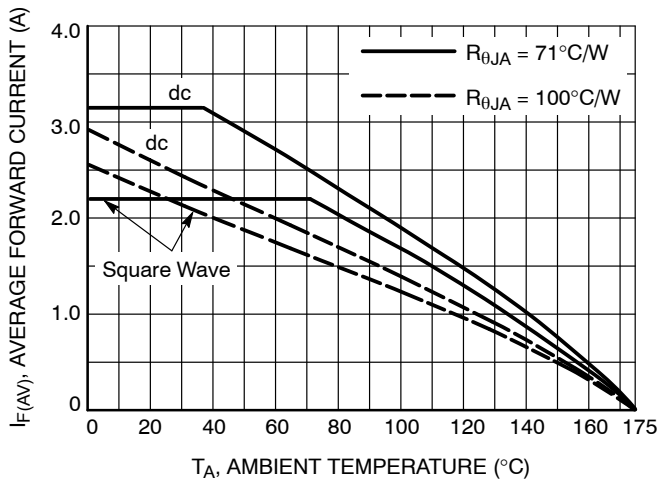

Figure 7. Current Derating, Ambient

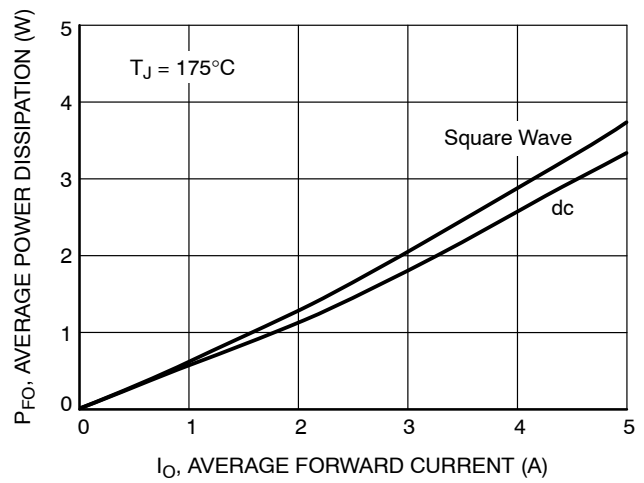

Figure 8. Maximum Forward Power Dissipation

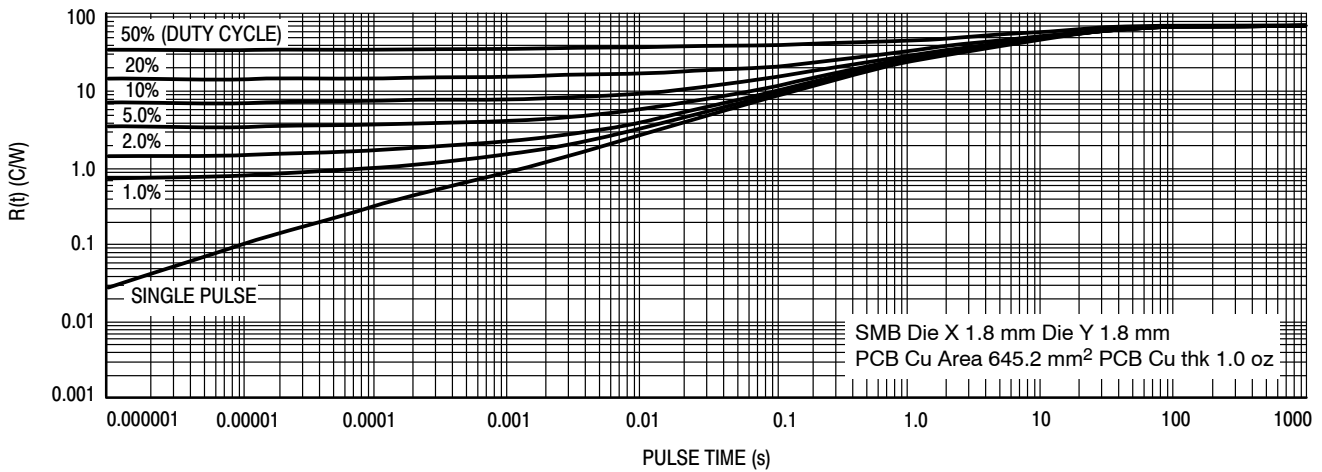

Figure 9. Thermal Response, Junction-to-Ambient (1 inch pad) – MBRS2H100T3G/NBR2H100T3G

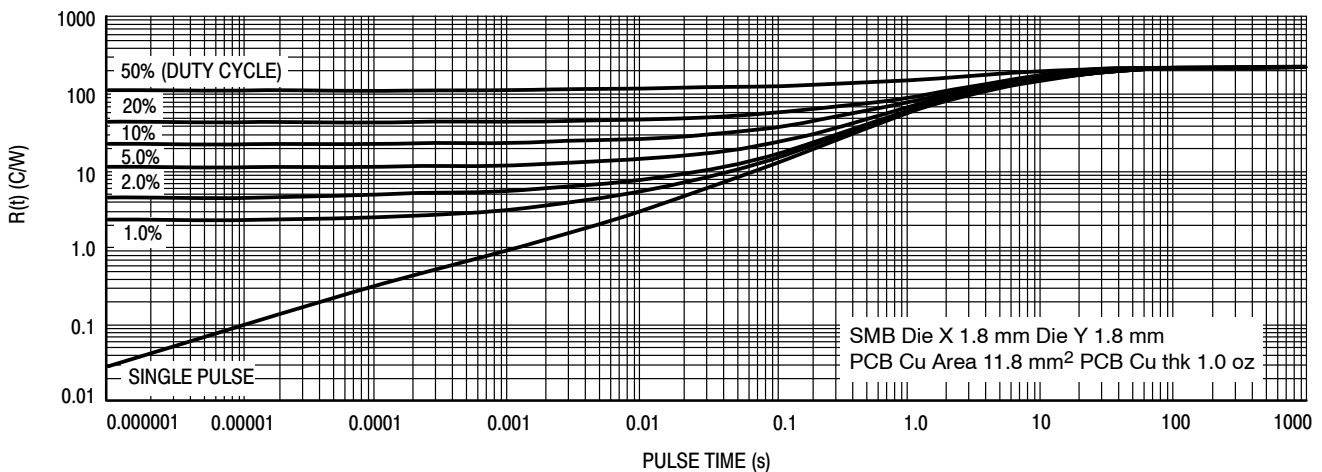
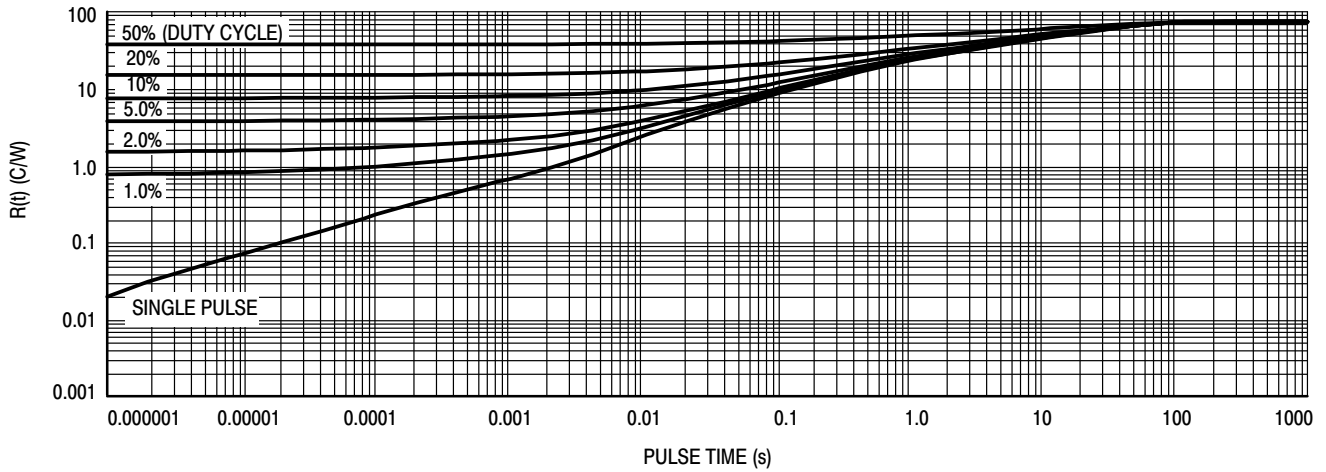

Figure 10. Thermal Response, Junction-to-Ambient (min pad) – MBRS2H100T3G/NBR2H100T3G

**MBRS2H100T3G, NBR2H100T3G, MBRA2H100T3G, NRVBA2H100T3G,**

**TYPICAL CHARACTERISTICS**



**Figure 11. Thermal Response, Junction-to-Ambient (1 inch pad) – MBRA2H100T3G/NRVBA2H100T3G**

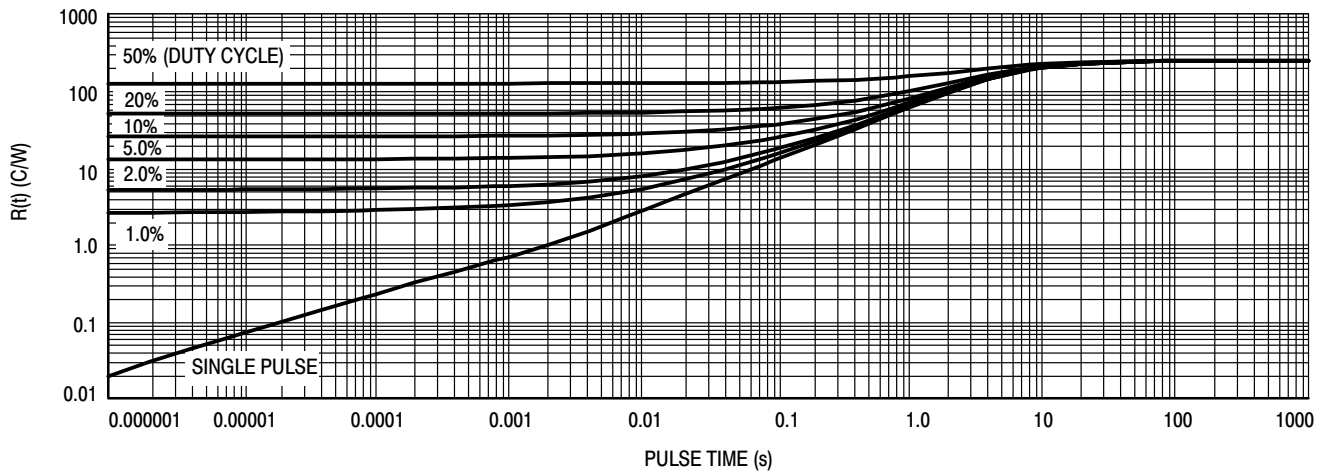

**Figure 12. Thermal Response, Junction-to-Ambient (min pad) – MBRA2H100T3G/NRVBA2H100T3G**

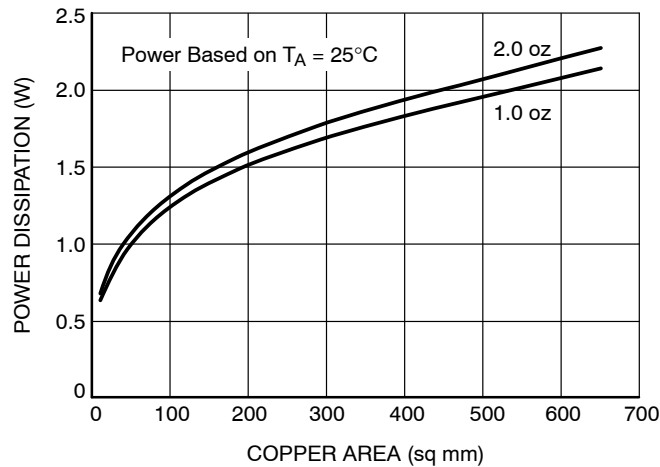
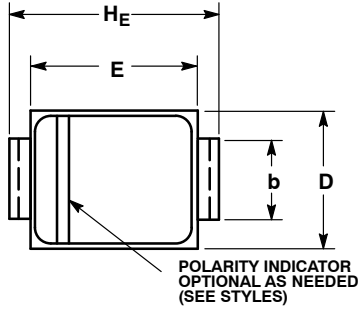

**Figure 13.  $P_D$ , Junction-to-Ambient (URS copper area)**

# MBRS2H100T3G, NBR2H100T3G, MBRA2H100T3G, NRVBA2H100T3G,

## PACKAGE DIMENSIONS

**SMA**  
CASE 403D-02  
ISSUE G



- NOTES:
1. DIMENSIONING AND TOLERANCING PER ANSI Y14.5M, 1982.
  2. CONTROLLING DIMENSION: INCH.
  3. DIMENSION b SHALL BE MEASURED WITHIN DIMENSION L.

DIM	MILLIMETERS			INCHES		
	MIN	NOM	MAX	MIN	NOM	MAX
A	1.97	2.10	2.20	0.078	0.083	0.087
A1	0.05	0.10	0.20	0.002	0.004	0.008
b	1.27	1.45	1.63	0.050	0.057	0.064
c	0.15	0.28	0.41	0.006	0.011	0.016
D	2.29	2.60	2.92	0.090	0.103	0.115
E	4.06	4.32	4.57	0.160	0.170	0.180
HE	4.83	5.21	5.59	0.190	0.205	0.220
L	0.76	1.14	1.52	0.030	0.045	0.060

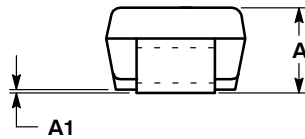
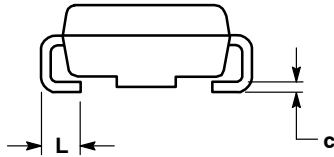

### SOLDERING FOOTPRINT\*

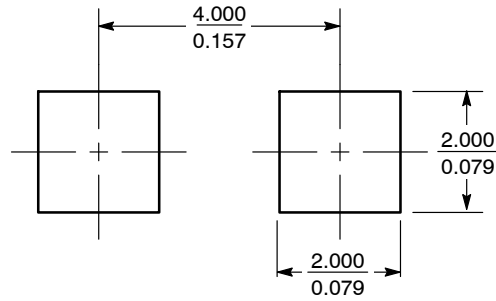

SCALE 8:1  $\left(\frac{\text{mm}}{\text{inches}}\right)$

\*For additional information on our Pb-Free strategy and soldering details, please download the ON Semiconductor Soldering and Mounting Techniques Reference Manual, SOLDERRM/D.

# MBRS2H100T3G, NBR2H100T3G, MBRA2H100T3G, NRVBA2H100T3G,

## PACKAGE DIMENSIONS

**SMB**  
CASE 403A-03  
ISSUE J

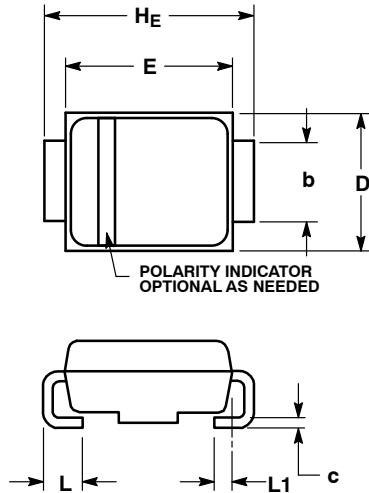

- NOTES:
1. DIMENSIONING AND TOLERANCING PER ANSI Y14.5M, 1982.
  2. CONTROLLING DIMENSION: INCH.
  3. DIMENSION b SHALL BE MEASURED WITHIN DIMENSION L1.

DIM	MILLIMETERS			INCHES		
	MIN	NOM	MAX	MIN	NOM	MAX
A	1.95	2.30	2.47	0.077	0.091	0.097
A1	0.05	0.10	0.20	0.002	0.004	0.008
b	1.96	2.03	2.20	0.077	0.080	0.087
c	0.15	0.23	0.31	0.006	0.009	0.012
D	3.30	3.56	3.95	0.130	0.140	0.156
E	4.06	4.32	4.60	0.160	0.170	0.181
HE	5.21	5.44	5.60	0.205	0.214	0.220
L	0.76	1.02	1.60	0.030	0.040	0.063
L1	0.51 REF			0.020 REF		

### SOLDERING FOOTPRINT\*

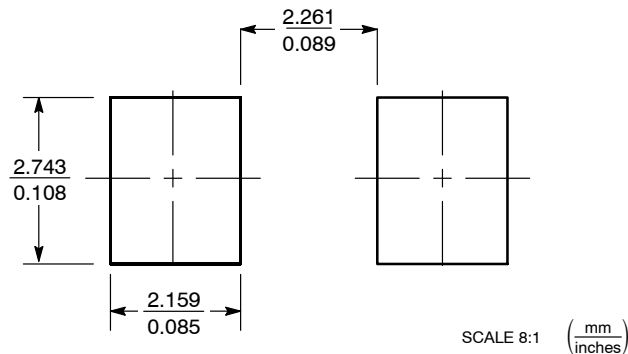

\*For additional information on our Pb-Free strategy and soldering details, please download the ON Semiconductor Soldering and Mounting Techniques Reference Manual, SOLDERRM/D.

ON Semiconductor and are registered trademarks of Semiconductor Components Industries, LLC (SCILLC). SCILLC owns the rights to a number of patents, trademarks, copyrights, trade secrets, and other intellectual property. A listing of SCILLC's product/patent coverage may be accessed at [www.onsemi.com/site/pdf/Patent-Marking.pdf](http://www.onsemi.com/site/pdf/Patent-Marking.pdf). SCILLC reserves the right to make changes without further notice to any products herein. SCILLC makes no warranty, representation or guarantee regarding the suitability of its products for any particular purpose, nor does SCILLC assume any liability arising out of the application or use of any product or circuit, and specifically disclaims any and all liability, including without limitation special, consequential or incidental damages. "Typical" parameters which may be provided in SCILLC data sheets and/or specifications can and do vary in different applications and actual performance may vary over time. All operating parameters, including "Typicals" must be validated for each customer application by customer's technical experts. SCILLC does not convey any license under its patent rights nor the rights of others. SCILLC products are not designed, intended, or authorized for use as components in systems intended for surgical implant into the body, or other applications intended to support or sustain life, or for any other application in which the failure of the SCILLC product could create a situation where personal injury or death may occur. Should Buyer purchase or use SCILLC products for any such unintended or unauthorized application, Buyer shall indemnify and hold SCILLC and its officers, employees, subsidiaries, affiliates, and distributors harmless against all claims, costs, damages, and expenses, and reasonable attorney fees arising out of, directly or indirectly, any claim of personal injury or death associated with such unintended or unauthorized use, even if such claim alleges that SCILLC was negligent regarding the design or manufacture of the part. SCILLC is an Equal Opportunity/Affirmative Action Employer. This literature is subject to all applicable copyright laws and is not for resale in any manner.

### PUBLICATION ORDERING INFORMATION

**LITERATURE FULFILLMENT:**  
Literature Distribution Center for ON Semiconductor  
P.O. Box 5163, Denver, Colorado 80217 USA  
**Phone:** 303-675-2175 or 800-344-3860 Toll Free USA/Canada  
**Fax:** 303-675-2176 or 800-344-3867 Toll Free USA/Canada  
**Email:** [orderlit@onsemi.com](mailto:orderlit@onsemi.com)

**N. American Technical Support:** 800-282-9855 Toll Free  
USA/Canada  
**Europe, Middle East and Africa Technical Support:**  
Phone: 421 33 790 2910  
**Japan Customer Focus Center**  
Phone: 81-3-5817-1050

**ON Semiconductor Website:** [www.onsemi.com](http://www.onsemi.com)  
**Order Literature:** <http://www.onsemi.com/orderlit>  
For additional information, please contact your local Sales Representative

# Mouser Electronics

Authorized Distributor

Click to View Pricing, Inventory, Delivery & Lifecycle Information:

[ON Semiconductor:](#)

[MBRA2H100T3G](#) [MBRS2H100T3G](#)