

# MCH6660



## Power MOSFET

20V, 136mΩ, 2A, -20V, 266mΩ, -1.5A Complementary Dual

ON Semiconductor®

www.onsemi.com

### Features

- ON-resistance Nch :  $R_{DS(on)1}=105m\Omega$ (typ.)  
Pch :  $R_{DS(on)1}=205m\Omega$ (typ.)
- 1.8V Drive
- Pb-Free, Halogen Free and RoHS Compliance
- ESD Diode - Protected Gate
- Ultrasmall Package MCPH6(2.0mm×2.1mm×0.85mm)
- Nch MOSFET and Pch MOSFET are put in MCPH6 Package

### Applications

- General-Purpose Switching Device Applications

### Specifications

Absolute Maximum Ratings at  $T_a=25^\circ C$

Parameter	Symbol	Conditions	N-channel	P-channel	Unit
Drain-to-Source Voltage	$V_{DSS}$		20	-20	V
Gate-to-Source Voltage	$V_{GSS}$		$\pm 10$	$\pm 10$	V
Drain Current (DC)	$I_D$		2	-1.5	A
Drain Current (Pulse)	$I_{DP}$	$PW \leq 10\mu s$ , duty cycle $\leq 1\%$	8	-6	A
Power Dissipation	$P_D$	When mounted on ceramic substrate (900mm <sup>2</sup> ×0.8mm) 1unit	0.8		W
Junction Temperature	$T_j$		150		°C
Storage Temperature	$T_{stg}$		-55 to +150		°C

Stresses exceeding those listed in the Maximum Ratings table may damage the device. If any of these limits are exceeded, device functionality should not be assumed, damage may occur and reliability may be affected.

### Package Dimensions

unit : mm (typ)

7022A-006

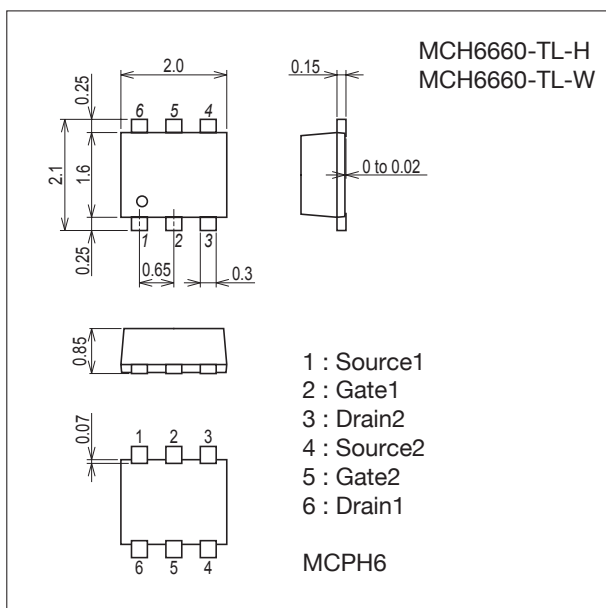

### Product & Package Information

- Package : MCPH6
- JEITA, JEDEC : SC-88, SC-70-6, SOT-363
- Minimum Packing Quantity : 3,000 pcs./reel

### Packing Type : TL

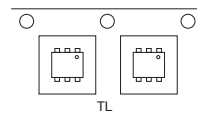

### Marking

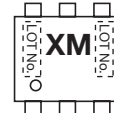

### Electrical Connection

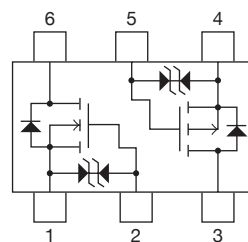

### ORDERING INFORMATION

See detailed ordering and shipping information on page 8 of this data sheet.

# MCH6660

## Electrical Characteristics at Ta=25°C

Parameter	Symbol	Conditions	Value			Unit
			min	typ	max	
[N-channel]						
Drain-to-Source Breakdown Voltage	V(BR)DSS	ID=1mA, VGS=0V	20			V
Zero-Gate Voltage Drain Current	IDSS	VDS=20V, VGS=0V			1	μA
Gate-to-Source Leakage Current	IGSS	VGS=±8V, VDS=0V			±10	μA
Gate Threshold Voltage	VGS(th)	VDS=10V, ID=1mA	0.4		1.3	V
Forward Transconductance	gFS	VDS=10V, ID=1A		1.9		S
Static Drain-to-Source On-State Resistance	RDS(on)1	ID=1A, VGS=4.5V		105	136	mΩ
	RDS(on)2	ID=0.5A, VGS=2.5V		147	205	mΩ
	RDS(on)3	ID=0.3A, VGS=1.8V		212	318	mΩ
Input Capacitance	Ciss	VDS=10V, f=1MHz		128		pF
Output Capacitance	Coss			28		pF
Reverse Transfer Capacitance	Crss			21		pF
Turn-ON Delay Time	t <sub>d(on)</sub>		See specified Test Circuit.		5.1	
Rise Time	t <sub>r</sub>			11		ns
Turn-OFF Delay Time	t <sub>d(off)</sub>			14.5		ns
Fall Time	t <sub>f</sub>			12		ns
Total Gate Charge	Qg	VDS=10V, VGS=4.5V, ID=2A			1.8	
Gate-to-Source Charge	Qgs			0.3		nC
Gate-to-Drain "Miller" Charge	Qgd			0.55		nC
Forward Diode Voltage	VSD		IS=2A, VGS=0V		0.85	1.2
[P-channel]						
Drain-to-Source Breakdown Voltage	V(BR)DSS	ID=-1mA, VGS=0V	-20			V
Zero-Gate Voltage Drain Current	IDSS	VDS=-20V, VGS=0V			-1	μA
Gate-to-Source Leakage Current	IGSS	VGS=±8V, VDS=0V			±10	μA
Gate Threshold Voltage	VGS(th)	VDS=-10V, ID=-1mA	-0.4		-1.4	V
Forward Transconductance	gFS	VDS=-10V, ID=-750mA		1.9		S
Static Drain-to-Source On-State Resistance	RDS(on)1	ID=-750mA, VGS=-4.5V		205	266	mΩ
	RDS(on)2	ID=-300mA, VGS=-2.5V		295	413	mΩ
	RDS(on)3	ID=-100mA, VGS=-1.8V		430	645	mΩ
Input Capacitance	Ciss	VDS=-10V, f=1MHz		120		pF
Output Capacitance	Coss			26		pF
Reverse Transfer Capacitance	Crss			20		pF
Turn-ON Delay Time	t <sub>d(on)</sub>		See specified Test Circuit.		5.3	
Rise Time	t <sub>r</sub>			9.7		ns
Turn-OFF Delay Time	t <sub>d(off)</sub>			16		ns
Fall Time	t <sub>f</sub>			14		ns
Total Gate Charge	Qg	VDS=-10V, VGS=-4.5V, ID=-1.5A			1.7	
Gate-to-Source Charge	Qgs			0.28		nC
Gate-to-Drain "Miller" Charge	Qgd			0.47		nC
Forward Diode Voltage	VSD		IS=-1.5A, VGS=0V		-0.89	-1.2

Product parametric performance is indicated in the Electrical Characteristics for the listed test conditions, unless otherwise noted. Product performance may not be indicated by the Electrical Characteristics if operated under different conditions.

## Thermal Resistance Ratings

Parameter	Symbol	Value	Unit
Junction to Ambient When mounted on ceramic substrate (900mm <sup>2</sup> ×0.8mm) 1unit	R <sub>θJA</sub>	156.3	°C/W

## Switching Time Test Circuit

[N-channel]

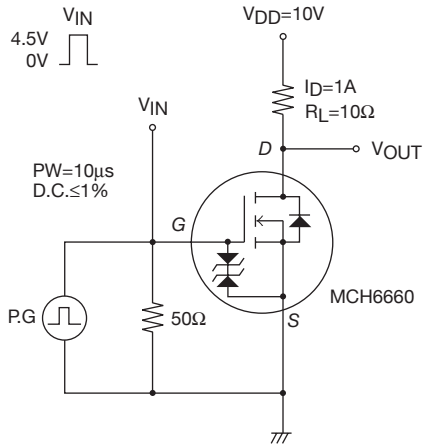

[P-channel]

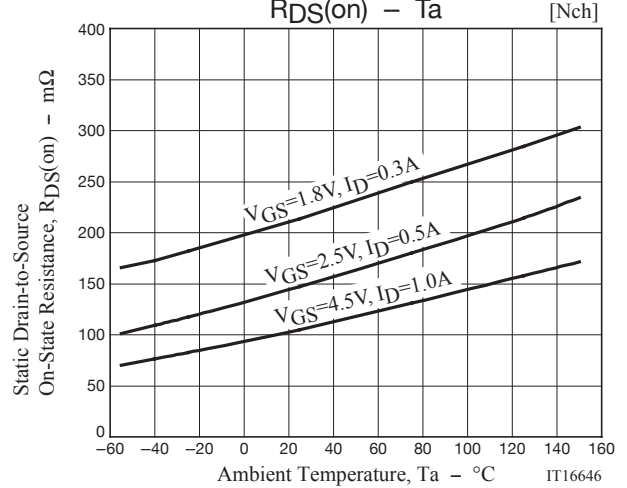
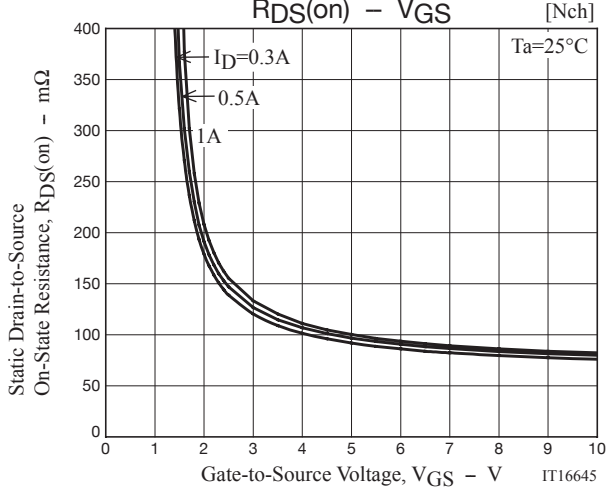
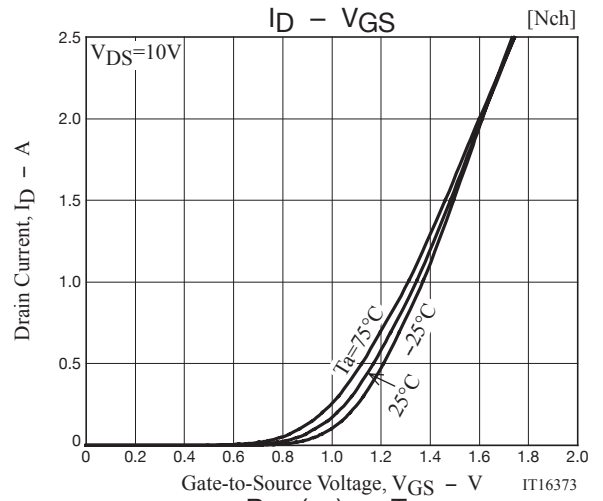
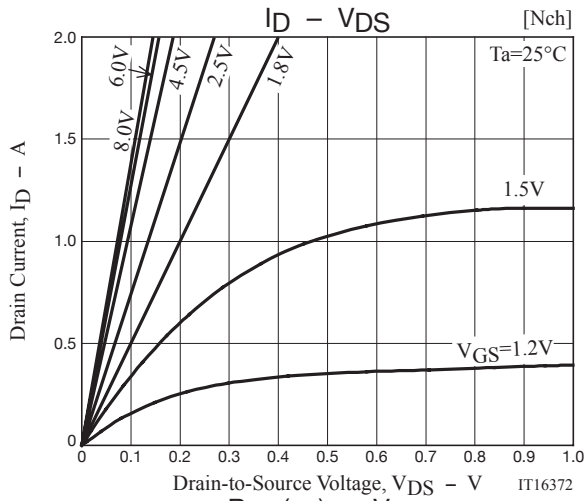
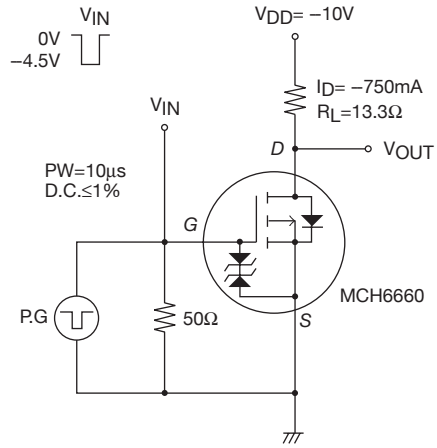

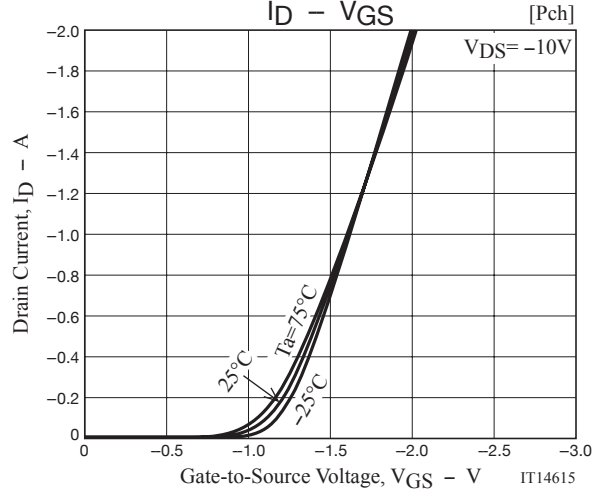
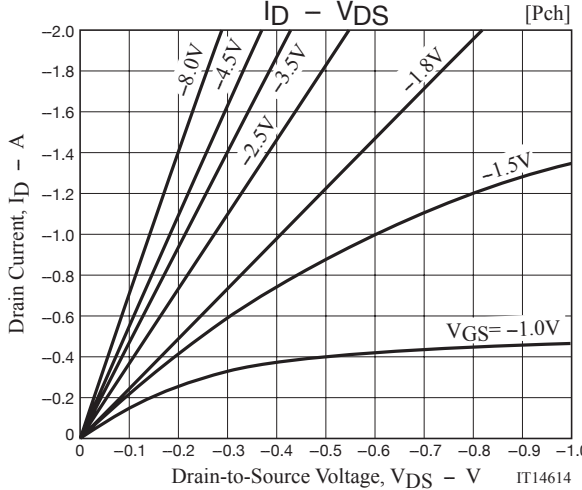
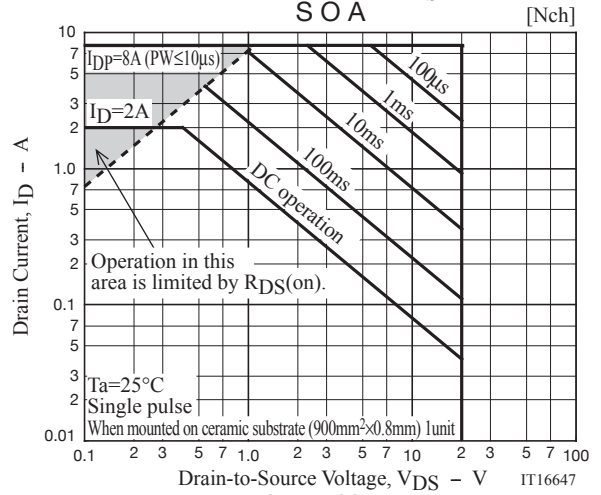
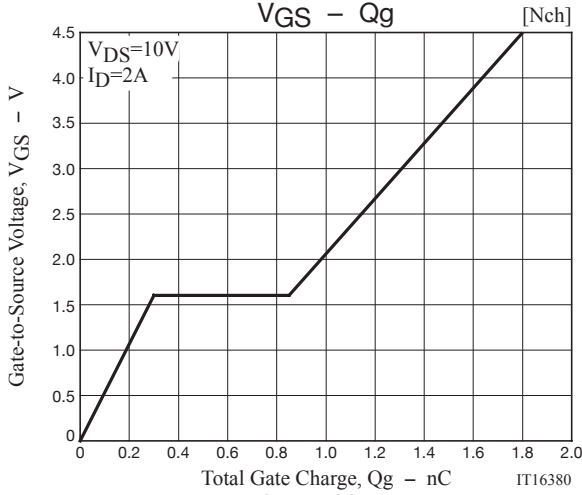
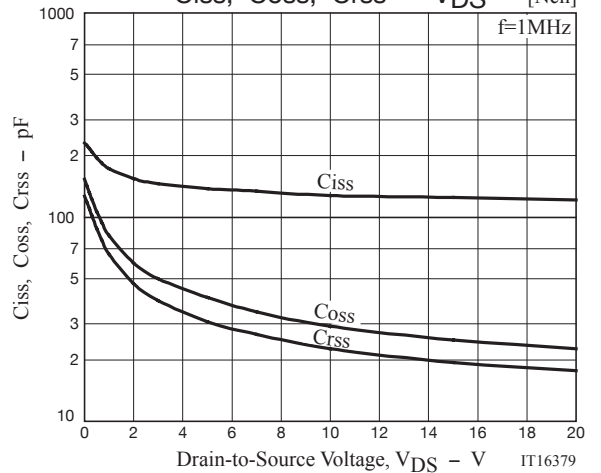
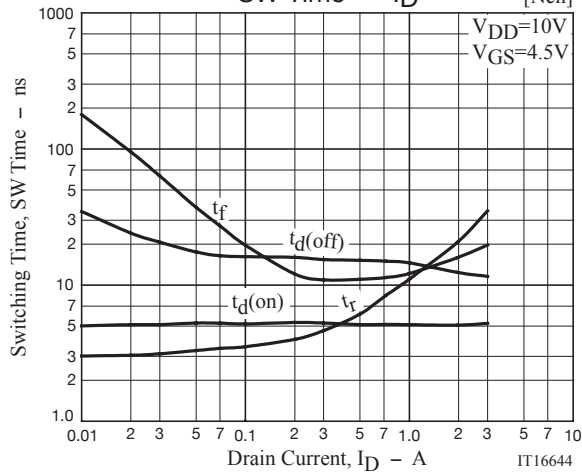
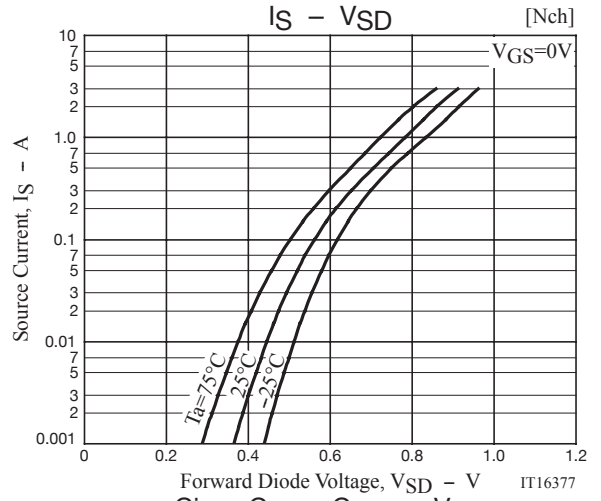
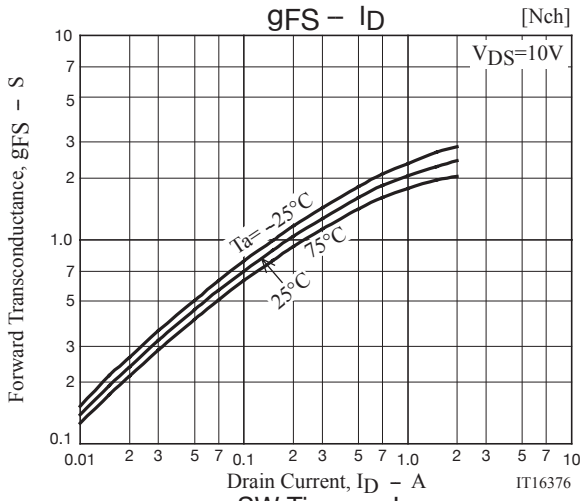

# MCH6660

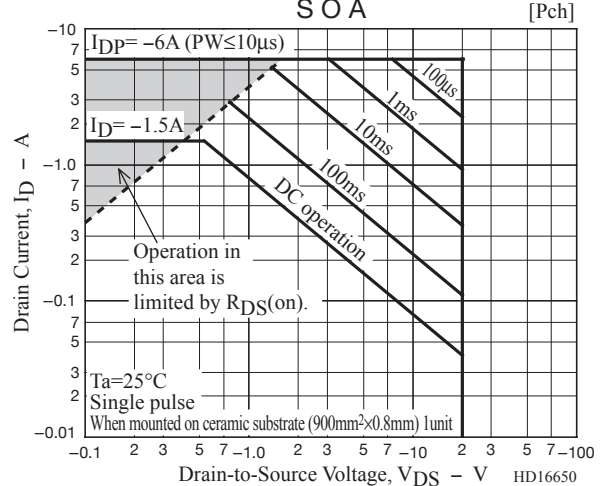
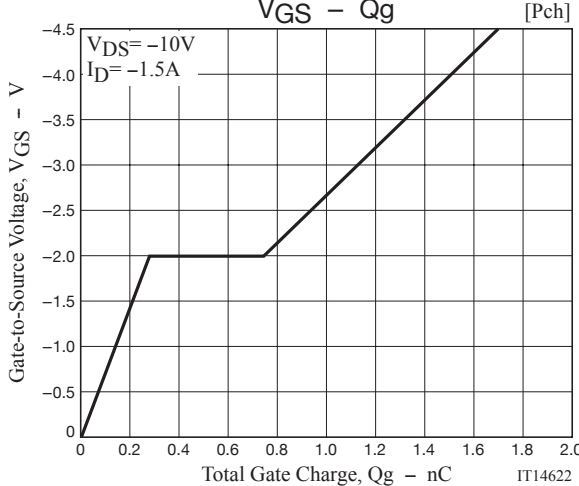
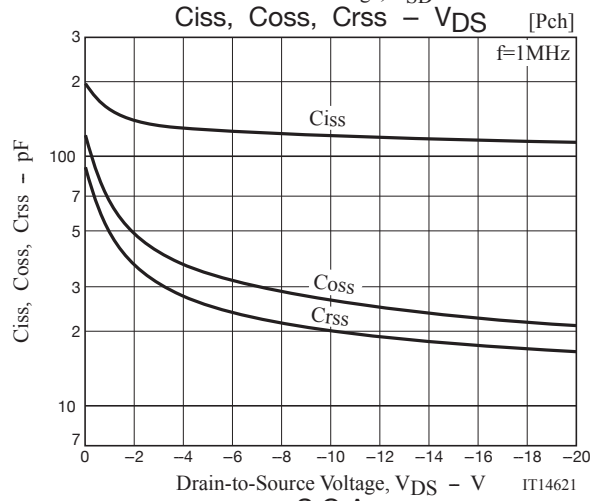
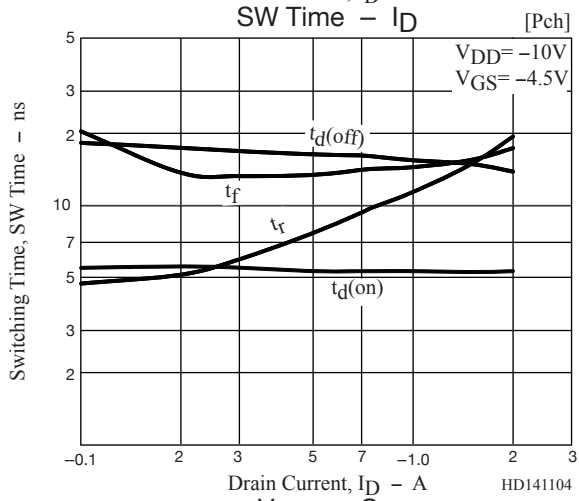
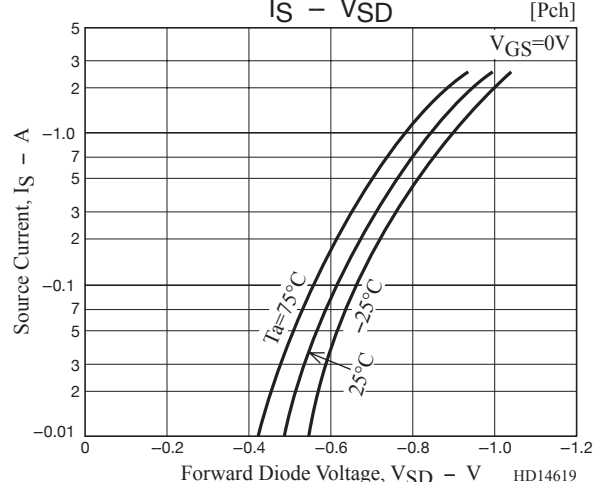
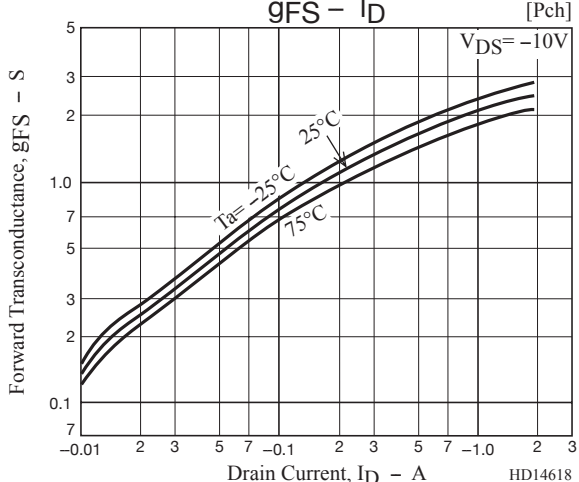
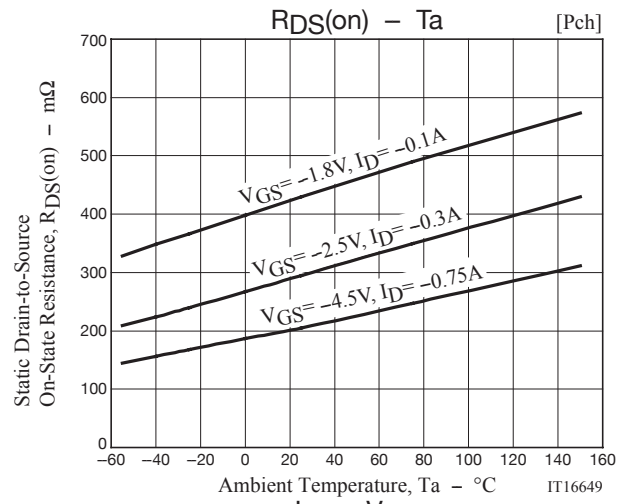
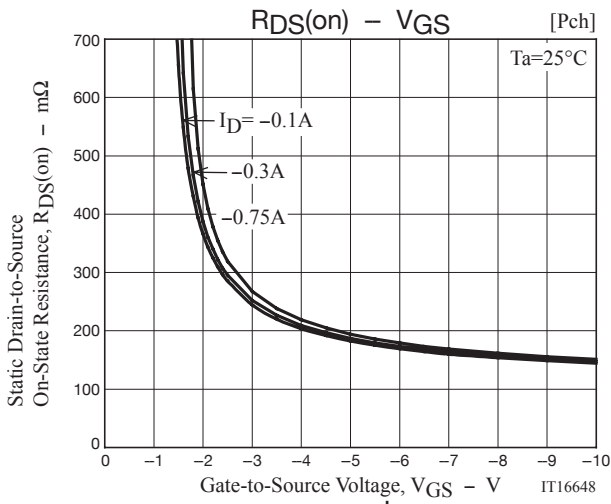

# MCH6660

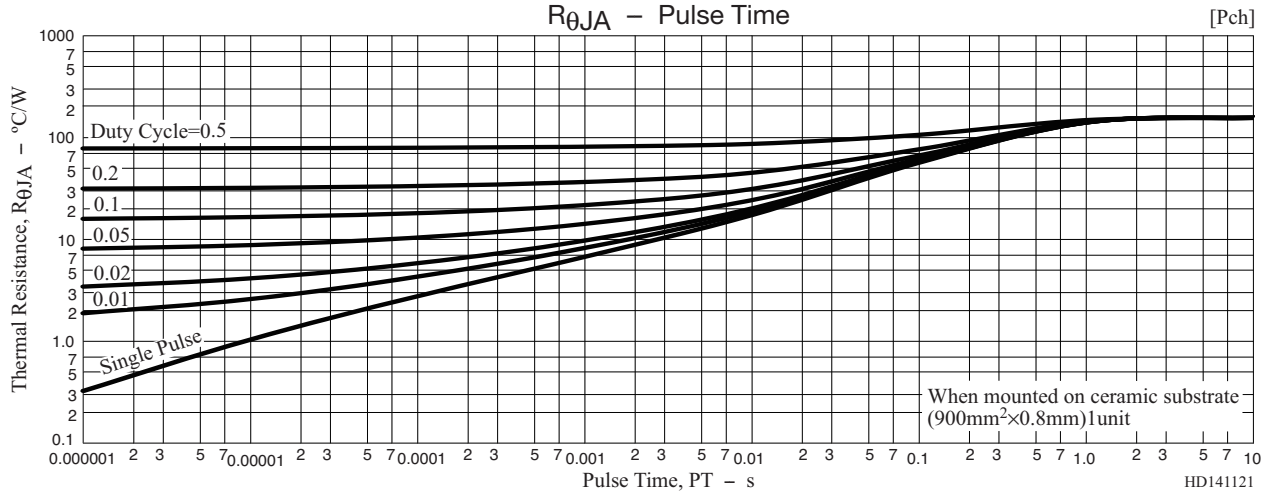
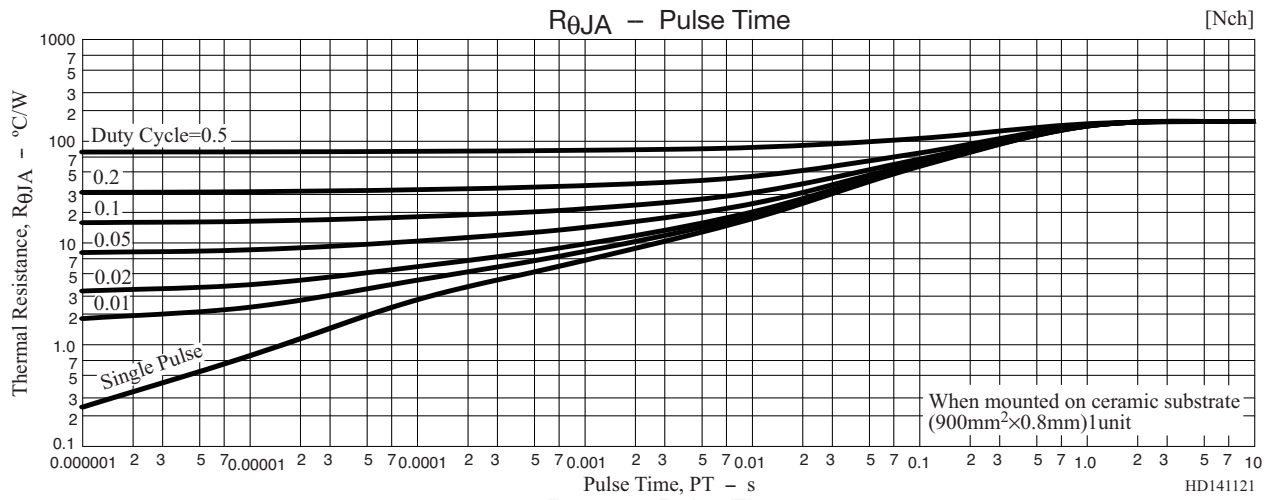
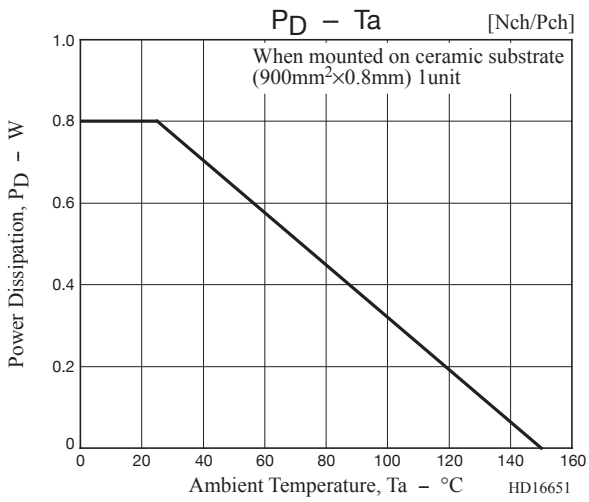

# MCH6660

## Package Dimensions

unit : mm

MCH6660-TL-H, MCH6660-TL-W

SC-88FL / MCPH6  
CASE 419AS  
ISSUE O

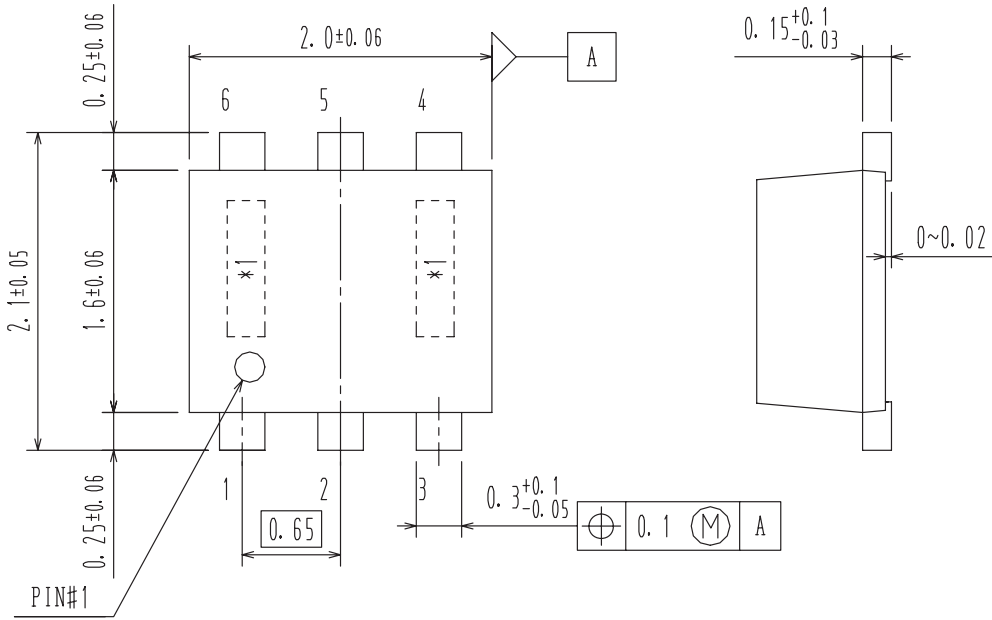

## Recommended Soldering Footprint

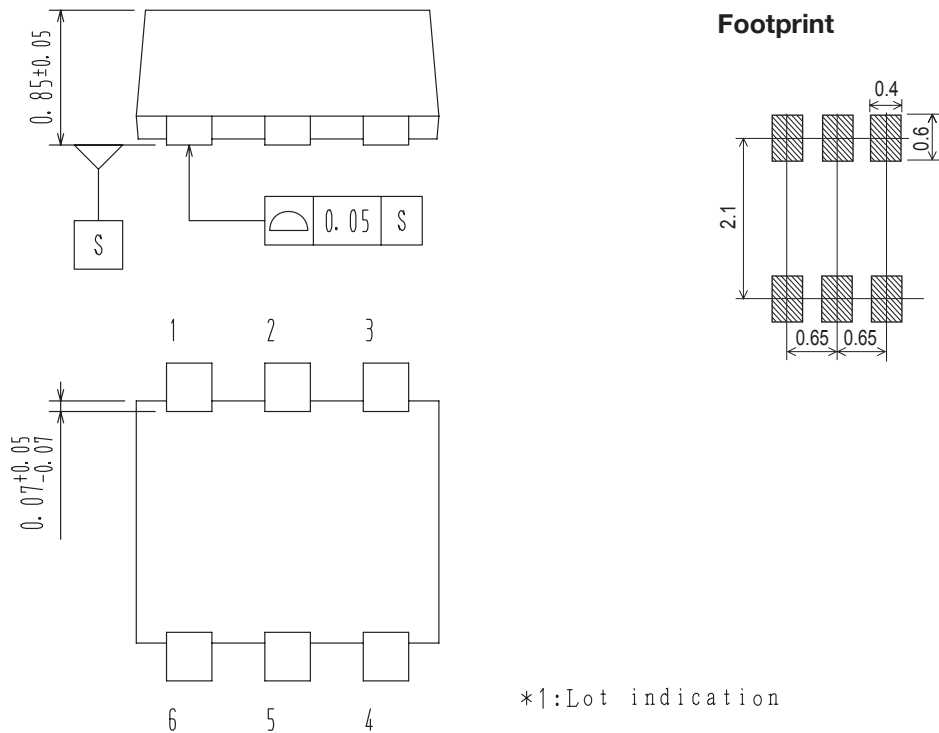

# MCH6660

## ORDERING INFORMATION

Device	Package	Shipping	memo
MCH6660-TL-H	MCPH6	3,000pcs./reel	Pb-Free and Halogen Free
MCH6660-TL-W			

Note on usage : Since the MCH6660 is a MOSFET product, please avoid using this device in the vicinity of highly charged objects.

ON Semiconductor and the ON logo are registered trademarks of Semiconductor Components Industries, LLC (SCILLC) or its subsidiaries in the United States and/or other countries. SCILLC owns the rights to a number of patents, trademarks, copyrights, trade secrets, and other intellectual property. A listing of SCILLC's product/patent coverage may be accessed at [www.onsemi.com/site/pdf/Patent-Marking.pdf](http://www.onsemi.com/site/pdf/Patent-Marking.pdf). SCILLC reserves the right to make changes without further notice to any products herein. SCILLC makes no warranty, representation or guarantee regarding the suitability of its products for any particular purpose, nor does SCILLC assume any liability arising out of the application or use of any product or circuit, and specifically disclaims any and all liability, including without limitation special, consequential or incidental damages. "Typical" parameters which may be provided in SCILLC data sheets and/or specifications can and do vary in different applications and actual performance may vary over time. All operating parameters, including "Typicals" must be validated for each customer application by customer's technical experts. SCILLC does not convey any license under its patent rights nor the rights of others. SCILLC products are not designed, intended, or authorized for use as components in systems intended for surgical implant into the body, or other applications intended to support or sustain life, or for any other application in which the failure of the SCILLC product could create a situation where personal injury or death may occur. Should Buyer purchase or use SCILLC products for any such unintended or unauthorized application, Buyer shall indemnify and hold SCILLC and its officers, employees, subsidiaries, affiliates, and distributors harmless against all claims, costs, damages, and expenses, and reasonable attorney fees arising out of, directly or indirectly, any claim of personal injury or death associated with such unintended or unauthorized use, even if such claim alleges that SCILLC was negligent regarding the design or manufacture of the part. SCILLC is an Equal Opportunity/Affirmative Action Employer. This literature is subject to all applicable copyright laws and is not for resale in any manner.



# Mouser Electronics

Authorized Distributor

Click to View Pricing, Inventory, Delivery & Lifecycle Information:

[ON Semiconductor:](#)

[MCH6660-TL-H](#)