

NCV1009

2.5 Volt Reference

The NCV1009 is a precision trimmed 2.5 V ± 5.0 mV shunt regulator diode. The low dynamic impedance and wide operating current range enhances its versatility. The tight reference tolerance is achieved by on-chip trimming which minimizes voltage tolerance and temperature drift.

A third terminal allows the reference voltage to be adjusted $\pm 5.0\%$ to calibrate out system errors. In many applications, the NCV1009Z can be used as a pin-to-pin replacement of the LT1009CZ and the LM136Z-2.5 with the external trim network eliminated.

Features

- 0.2% Initial Tolerance Max.
- Guaranteed Temperature Stability
- Maximum 0.6 Ω Dynamic Impedance
- Wide Operating Current Range
- Directly Interchangeable with LT1009 and LM136 for Improved Performance
- No Adjustments Needed for Minimum Temperature Coefficient
- Meets Mil Std 883C ESD Requirements
- Extended Operating Temperature Range for Use in Automotive Applications
- NCV Prefix, for Automotive and Other Applications Requiring Site and Change Control
- Pb-Free Packages are Available

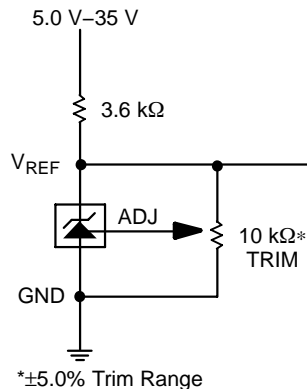

If the external trim resistor is not used, the "ADJ. PIN" should be left floating. The 10k trim potentiometer does not effect the temperature coefficient of the device.

Figure 1. Application Diagram



ON Semiconductor®

<http://onsemi.com>

MARKING DIAGRAMS



**SOIC-8
D SUFFIX
CASE 751**

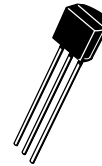
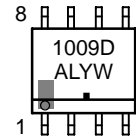

**TO-92
Z SUFFIX
CASE 29**

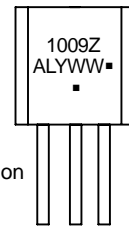

- A = Assembly Location
- L = Wafer Lot
- Y = Year
- WW, W = Work Week
- = Pb-Free Package

(Note: Microdot may be in either location)

PIN CONNECTIONS

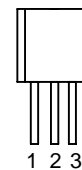
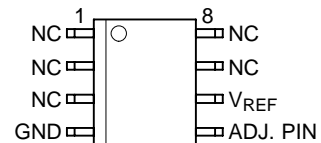

- Pin 1. ADJ. PIN
- Pin 2. VREF
- Pin 3. GND

ORDERING INFORMATION

Device	Package	Shipping
NCV1009D	SOIC-8	95 Units/Rail
NCV1009DR2	SOIC-8	2500 Tape & Reel
NCV1009DR2G	SOIC-8 (Pb-Free)	2500 Tape & Reel
NCV1009Z	TO-92	2000 Units/Rail
NCV1009ZG	TO-92 (Pb-Free)	2000 Tape & Reel

†For information on tape and reel specifications, including part orientation and tape sizes, please refer to our Tape and Reel Packaging Specification Brochure, BRD8011/D.

NCV1009

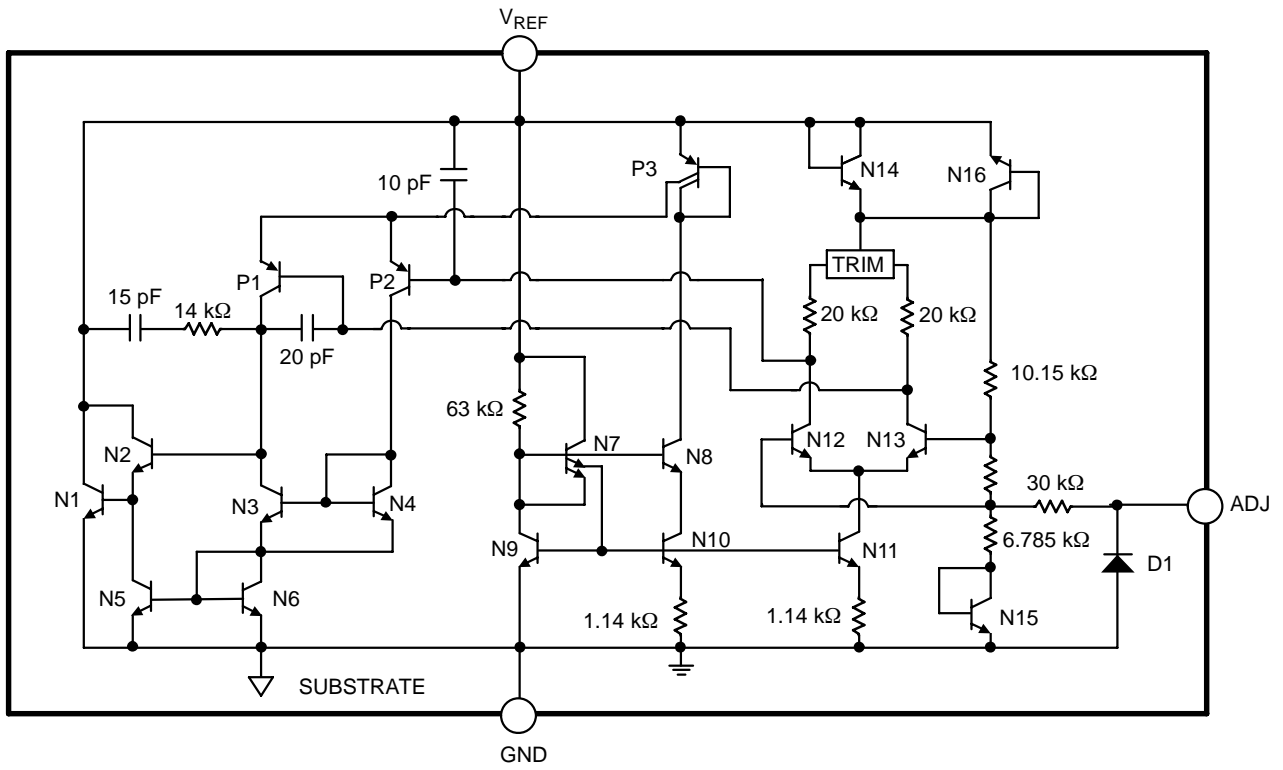

Figure 2. Block Diagram

NCV1009

MAXIMUM RATINGS*

Rating	Value	Unit
Reverse Current	20	mA
Forward	10	mA
Package Thermal Resistance, SOIC-8: Junction-to-Case, $R_{\theta JC}$ Junction-to-Ambient, $R_{\theta JA}$	45 165	$^{\circ}C/W$ $^{\circ}C/W$
Package Thermal Resistance, TO-92: Junction-to-Case, $R_{\theta JC}$ Junction-to-Ambient, $R_{\theta JA}$	- 170	$^{\circ}C/W$ $^{\circ}C/W$
Operating Temperature Range	-40 to +125	$^{\circ}C$
Storage Temperature Range	-65 to +150	$^{\circ}C$
Lead Temperature Soldering:	Wave Solder (through hole styles only) (Note 1) Reflow: (SMD styles only) (Notes 2, 3)	260 peak 240 peak $^{\circ}C$ $^{\circ}C$

Maximum ratings are those values beyond which device damage can occur. Maximum ratings applied to the device are individual stress limit values (not normal operating conditions) and are not valid simultaneously. If these limits are exceeded, device functional operation is not implied, damage may occur and reliability may be affected.

*The maximum package power dissipation must be observed.

1. 10 second maximum
2. 60 second maximum above 183 $^{\circ}C$.
3. -5 $^{\circ}C$ / +0 $^{\circ}C$ allowable conditions.

ELECTRICAL CHARACTERISTICS ($T_A = 25^{\circ}C$ unless otherwise specified.)

Characteristic	Test Conditions	Min	Typ	Max	Unit
Reverse Breakdown Voltage	$I_R = 1.0 \text{ mA}$	2.492	2.500	2.508	V
Reverse Breakdown Voltage	$-40^{\circ}C \leq T_A \leq 125^{\circ}C$	2.480	2.500	2.508	V
Reverse Breakdown Voltage Change with Current	$400 \mu A \leq I_R \leq 10 \text{ mA}$ (Note 4)	- -	2.6 3.0	5.0 6.0	mV mV
Reverse Dynamic Impedance	$I_R = 1.0 \text{ mA}$ (Note 4)	- -	0.2 0.4	1.0 1.4	Ω Ω
Temperature Stability Average Temperature Coefficient	$0^{\circ}C \leq T_A \leq 70^{\circ}C$, (Note 5) $0^{\circ}C \leq T_A \leq 70^{\circ}C$, (Note 5)	- -	1.8 15	- -	mV ppm/ $^{\circ}C$
Long Term Stability	$T_A = 25^{\circ}C \pm 0.1 C$, $I_R = 1.0 \text{ mA}$	-	20	-	ppm/kHr

4. Denotes the specifications which apply over full operating temperature range.
5. Average temperature coefficient is defined as the total voltage change divided by the specified temperature range.

TYPICAL PERFORMANCE CHARACTERISTICS

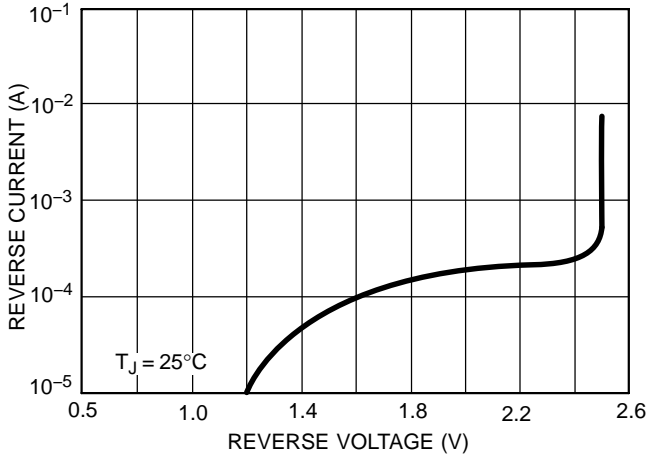

Figure 3. Reverse Current vs. Reverse Voltage

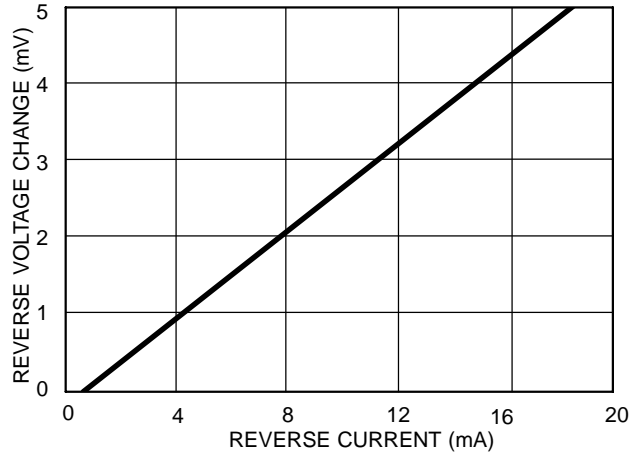

Figure 4. Change in Reverse Voltage vs. Reverse Current

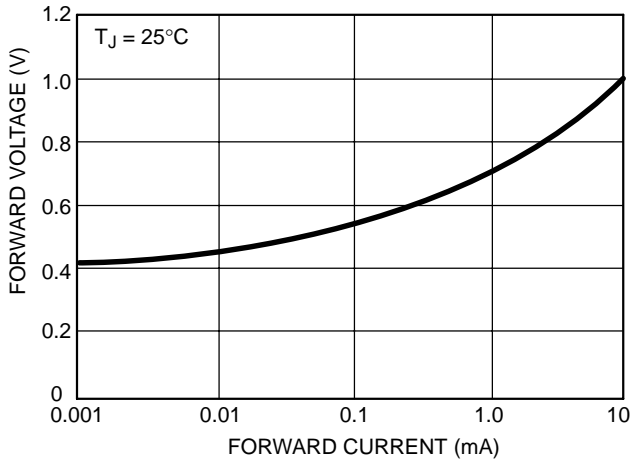

Figure 5. Forward Voltage vs. Forward Current

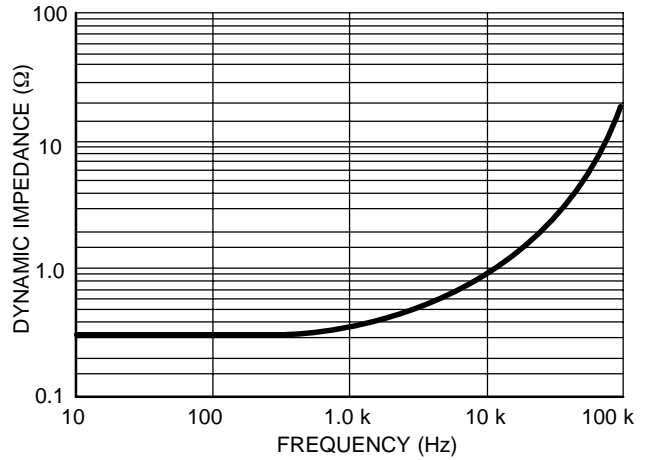

Figure 6. Dynamic Impedance vs. Frequency

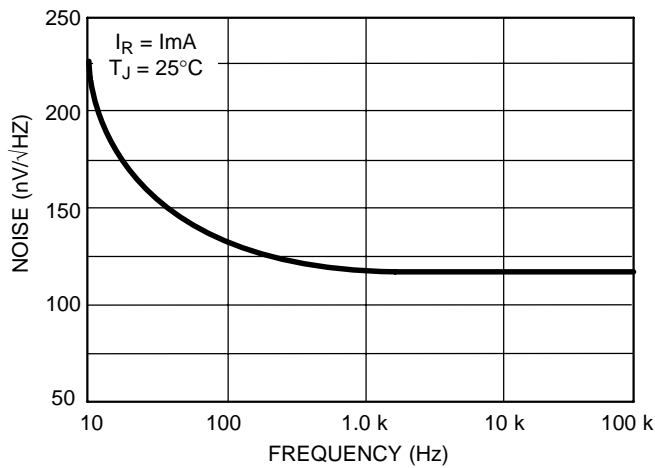

Figure 7. Zener Noise Voltage vs. Frequency

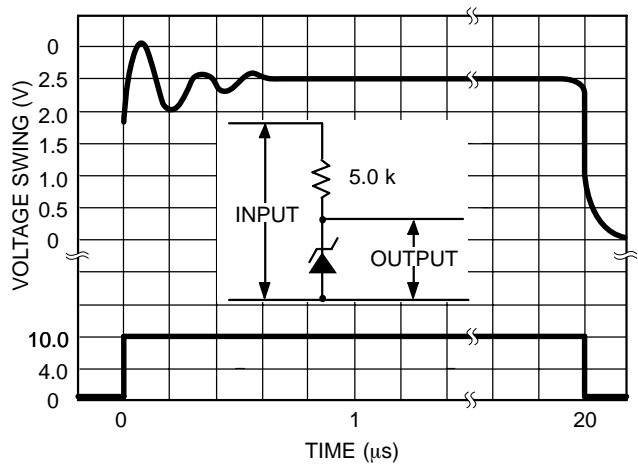
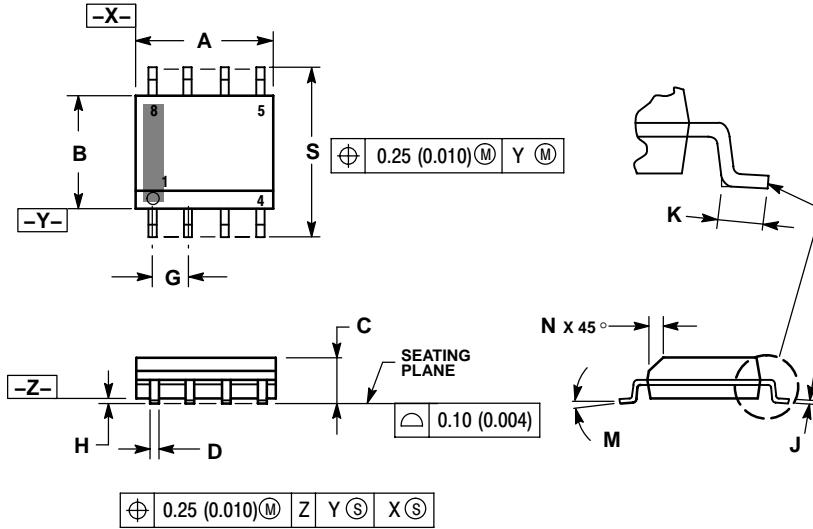

Figure 8. Response Time

NCV1009

PACKAGE DIMENSIONS

SOIC-8
CASE 751-07
ISSUE AG



NOTES:

1. DIMENSIONING AND TOLERANCING PER ANSI Y14.5M, 1982.
2. CONTROLLING DIMENSION: MILLIMETER.
3. DIMENSION A AND B DO NOT INCLUDE MOLD PROTRUSION.
4. MAXIMUM MOLD PROTRUSION 0.15 (0.006) PER SIDE.
5. DIMENSION D DOES NOT INCLUDE DAMBAR PROTRUSION. ALLOWABLE DAMBAR PROTRUSION SHALL BE 0.127 (0.005) TOTAL IN EXCESS OF THE D DIMENSION AT MAXIMUM MATERIAL CONDITION.
6. 751-01 THRU 751-06 ARE OBSOLETE. NEW STANDARD IS 751-07.

DIM	MILLIMETERS		INCHES	
	MIN	MAX	MIN	MAX
A	4.80	5.00	0.189	0.197
B	3.80	4.00	0.150	0.157
C	1.35	1.75	0.053	0.069
D	0.33	0.51	0.013	0.020
G	1.27 BSC		0.050 BSC	
H	0.10	0.25	0.004	0.010
J	0.19	0.25	0.007	0.010
K	0.40	1.27	0.016	0.050
M	0°	8°	0°	8°
N	0.25	0.50	0.010	0.020
S	5.80	6.20	0.228	0.244

SOLDERING FOOTPRINT*

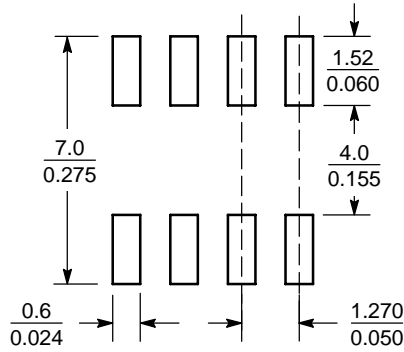

SCALE 6:1 $\left(\frac{\text{mm}}{\text{inches}}\right)$

*For additional information on our Pb-Free strategy and soldering details, please download the ON Semiconductor Soldering and Mounting Techniques Reference Manual, SOLDERRM/D.

NCV1009

PACKAGE DIMENSIONS

TO-92
CASE 29-11
ISSUE AL

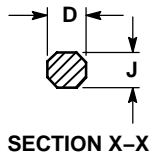
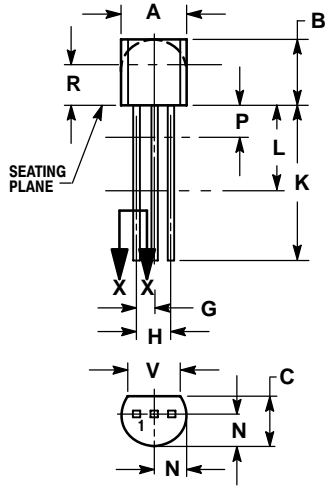

NOTES:

1. DIMENSIONING AND TOLERANCING PER ANSI Y14.5M, 1982.
2. CONTROLLING DIMENSION: INCH.
3. CONTOUR OF PACKAGE BEYOND DIMENSION R IS UNCONTROLLED.
4. LEAD DIMENSION IS UNCONTROLLED IN P AND BEYOND DIMENSION K MINIMUM.

DIM	INCHES		MILLIMETERS	
	MIN	MAX	MIN	MAX
A	0.175	0.205	4.45	5.20
B	0.170	0.210	4.32	5.33
C	0.125	0.165	3.18	4.19
D	0.016	0.021	0.407	0.533
G	0.045	0.055	1.15	1.39
H	0.095	0.105	2.42	2.66
J	0.015	0.020	0.39	0.50
K	0.500	---	12.70	---
L	0.250	---	6.35	---
N	0.080	0.105	2.04	2.66
P	---	0.100	---	2.54
R	0.115	---	2.93	---
V	0.135	---	3.43	---

ON Semiconductor and  are registered trademarks of Semiconductor Components Industries, LLC (SCILLC). SCILLC reserves the right to make changes without further notice to any products herein. SCILLC makes no warranty, representation or guarantee regarding the suitability of its products for any particular purpose, nor does SCILLC assume any liability arising out of the application or use of any product or circuit, and specifically disclaims any and all liability, including without limitation special, consequential or incidental damages. "Typical" parameters which may be provided in SCILLC data sheets and/or specifications can and do vary in different applications and actual performance may vary over time. All operating parameters, including "Typicals" must be validated for each customer application by customer's technical experts. SCILLC does not convey any license under its patent rights nor the rights of others. SCILLC products are not designed, intended, or authorized for use as components in systems intended for surgical implant into the body, or other applications intended to support or sustain life, or for any other application in which the failure of the SCILLC product could create a situation where personal injury or death may occur. Should Buyer purchase or use SCILLC products for any such unintended or unauthorized application, Buyer shall indemnify and hold SCILLC and its officers, employees, subsidiaries, affiliates, and distributors harmless against all claims, costs, damages, and expenses, and reasonable attorney fees arising out of, directly or indirectly, any claim of personal injury or death associated with such unintended or unauthorized use, even if such claim alleges that SCILLC was negligent regarding the design or manufacture of the part. SCILLC is an Equal Opportunity/Affirmative Action Employer. This literature is subject to all applicable copyright laws and is not for resale in any manner.

PUBLICATION ORDERING INFORMATION

LITERATURE FULFILLMENT:
Literature Distribution Center for ON Semiconductor
P.O. Box 61312, Phoenix, Arizona 85082-1312 USA
Phone: 480-829-7710 or 800-344-3860 Toll Free USA/Canada
Fax: 480-829-7709 or 800-344-3867 Toll Free USA/Canada
Email: orderlit@onsemi.com

N. American Technical Support: 800-282-9855 Toll Free USA/Canada

Japan: ON Semiconductor, Japan Customer Focus Center
2-9-1 Kamimeguro, Meguro-ku, Tokyo, Japan 153-0051
Phone: 81-3-5773-3850

ON Semiconductor Website: <http://onsemi.com>

Order Literature: <http://www.onsemi.com/litorder>

For additional information, please contact your local Sales Representative.

Mouser Electronics

Authorized Distributor

Click to View Pricing, Inventory, Delivery & Lifecycle Information:

[ON Semiconductor:](#)

[NCV1009DR2G](#)