

# NZL5V6ATT1

## SC75 Dual Common Anode Zener for ESD Protection

This dual monolithic silicon voltage suppressor is designed for applications requiring transient overvoltage protection capability. It is intended for use in voltage and ESD sensitive equipment such as computers, printers, business machines, communication systems, medical equipment, and other applications. Its dual junction common anode design protects four separate lines using only one package.

These devices are ideal for situations where board space is at a premium.

### Specification Features

- SC-75 Package Allows Two Separate Unidirectional Configurations
- Low Leakage < 1  $\mu\text{A}$  @ 3 V
- Breakdown Voltage: 5.3 – 5.9 V @ 1 mA
- Low Capacitance (40 pF typical between terminals)
- ESD Protection Meeting IEC61000-4-2
- Pb-Free Package is Available

### Mechanical Characteristics

- Void Free, Transfer-Molded, Thermosetting Plastic Case
- Corrosion Resistant Finish, Easily Solderable
- Package Designed for Optimal Automated Board Assembly
- Small Package Size for High Density Applications



ON Semiconductor®

<http://onsemi.com>

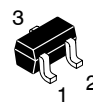
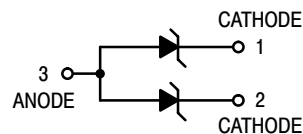

SC-75  
CASE 463  
STYLE 4

### MARKING DIAGRAM

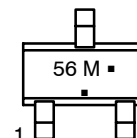

- 56 = Device Code
- M = Date Code\*
- = Pb-Free Package

(Note: Microdot may be in either location)

\*Date Code orientation may vary depending upon manufacturing location.

### ORDERING INFORMATION

Device	Package	Shipping†
NZL5V6ATT1	SC-75	3000/Tape & Reel
NZL5V6ATT1G	SC-75 (Pb-Free)	3000/Tape & Reel

†For information on tape and reel specifications, including part orientation and tape sizes, please refer to our Tape and Reel Packaging Specification Brochure, BRD8011/D.

# NZL5V6ATT1

## ELECTRICAL CHARACTERISTICS

( $T_A = 25^\circ\text{C}$  unless otherwise noted)

**UNIDIRECTIONAL** (Circuit tied to Pins 1 and 3, or 2 and 3)

Symbol	Parameter
$I_{PP}$	Maximum Reverse Peak Pulse Current
$V_C$	Clamping Voltage @ $I_{PP}$
$V_{RWM}$	Working Peak Reverse Voltage
$I_R$	Maximum Reverse Leakage Current @ $V_{RWM}$
$V_{BR}$	Breakdown Voltage @ $I_T$
$I_T$	Test Current
$\Theta V_{BR}$	Maximum Temperature Coefficient of $V_{BR}$
$I_F$	Forward Current
$V_F$	Forward Voltage @ $I_F$
$Z_{ZT}$	Maximum Zener Impedance @ $I_{ZT}$
$I_{ZK}$	Reverse Current
$Z_{ZK}$	Maximum Zener Impedance @ $I_{ZK}$

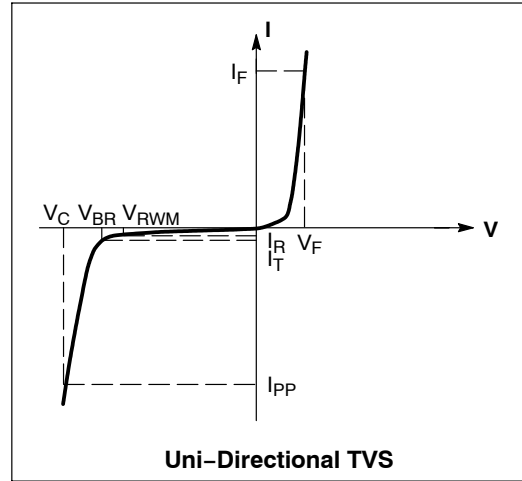

**MAXIMUM RATINGS** ( $T_A = 25^\circ\text{C}$  unless otherwise noted)

Characteristic	Symbol	Value	Unit
Steady State Power – 1 Diode (Note 1)	$P_D$	150	mW
Maximum Junction Temperature	$T_{Jmax}$	150	$^\circ\text{C}$
Operating Junction and Storage Temperature Range	$T_J T_{stg}$	-55 to +150	$^\circ\text{C}$
ESD Discharge IEC61000-4-2, Air Discharge IEC61000-4-2, Contact Discharge	$V_{PP}$	$\pm 15$ $\pm 8$	kV
Lead Solder Temperature (10 seconds duration)	$T_L$	260	$^\circ\text{C}$

Stresses exceeding Maximum Ratings may damage the device. Maximum Ratings are stress ratings only. Functional operation above the Recommended Operating Conditions is not implied. Extended exposure to stresses above the Recommended Operating Conditions may affect device reliability.

1. Only 1 diode under power. For all 4 diodes under power,  $P_D$  will be 25%. Mounted on FR-4 board with min pad.

## ELECTRICAL CHARACTERISTICS

Device	Breakdown Voltage $V_{BR}$ @ 1 mA (V)			Leakage Current $I_{RM}$ @ $V_{RM} = 3.0$ V ( $\mu\text{A}$ )	$V_C$ @ $I_{PP}$ (Note 2)		Typical Capacitance @ 0 V Bias @ 1 MHz (pF)	Max $V_F$ @ $I_F = 10$ mA (V)
	Min	Nom	Max		$V_C$ (V)	$I_{PP}$ (A)		
NZL5V6	5.3	5.6	5.9	1.0	9.97	6.11	40	1.25

2. Surge current waveform per Figure 2 and clamping voltage ( $V_C$ ) per Figure 6.

# NZL5V6ATT1

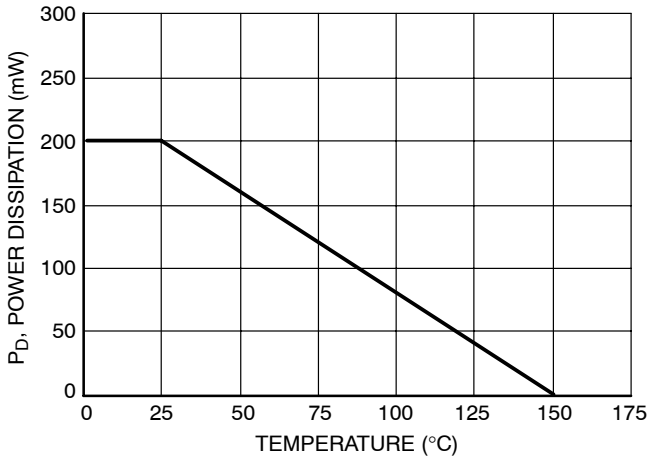

Figure 1. Steady State Power Derating Curve

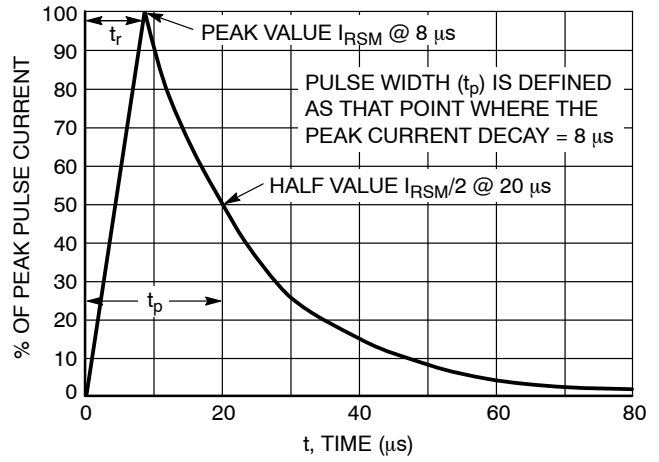

Figure 2. 8 X 20  $\mu$ s Pulse Waveform

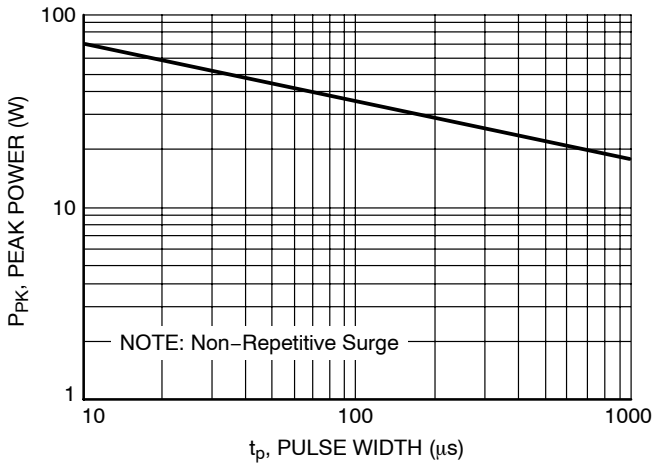

Figure 3. Pulse Rating Curve

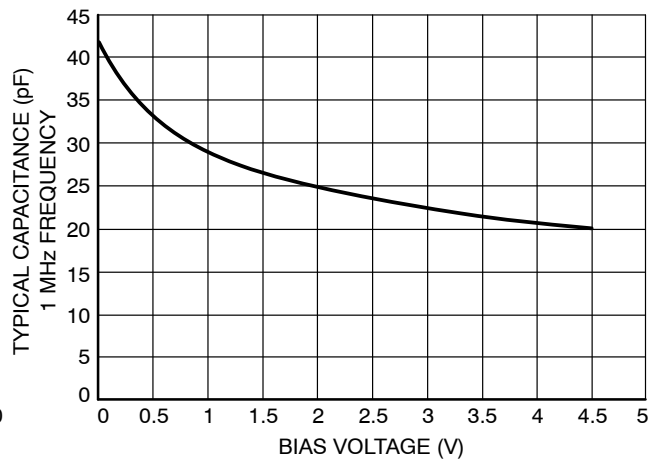

Figure 4. Capacitance

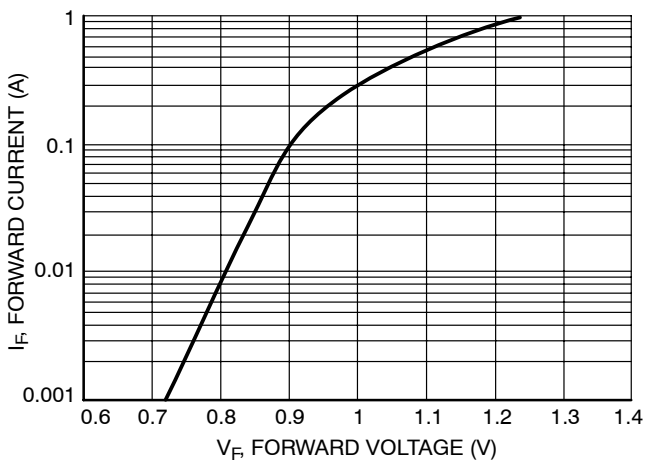

Figure 5. Forward Current versus Forward Voltage

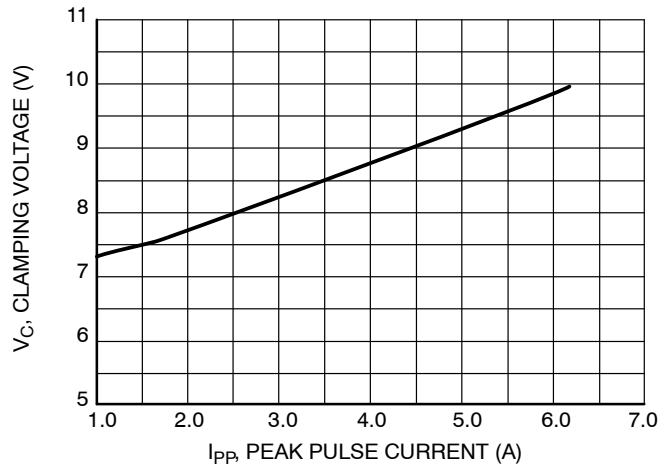
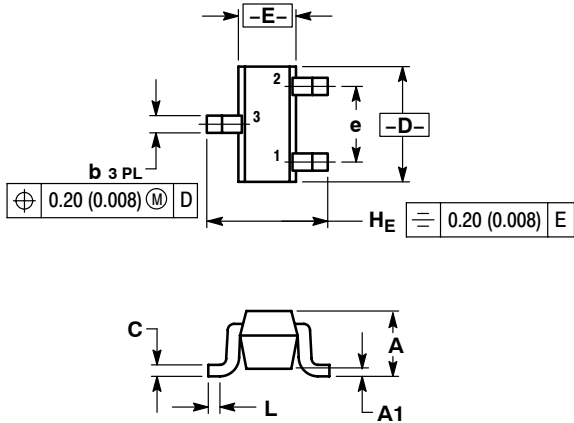

Figure 6. Clamping Voltage versus Peak Pulse Current (8 x 20  $\mu$ s Pulse)

# NZL5V6ATT1

## PACKAGE DIMENSIONS

SC-75/SOT-416  
CASE 463-01  
ISSUE F



- NOTES:  
1. DIMENSIONING AND TOLERANCING PER ANSI Y14.5M, 1982.  
2. CONTROLLING DIMENSION: MILLIMETER.

DIM	MILLIMETERS			INCHES		
	MIN	NOM	MAX	MIN	NOM	MAX
A	0.70	0.80	0.90	0.027	0.031	0.035
A1	0.00	0.05	0.10	0.000	0.002	0.004
b	0.15	0.20	0.30	0.006	0.008	0.012
C	0.10	0.15	0.25	0.004	0.006	0.010
D	1.55	1.60	1.65	0.059	0.063	0.067
E	0.70	0.80	0.90	0.027	0.031	0.035
e	1.00 BSC			0.04 BSC		
L	0.10	0.15	0.20	0.004	0.006	0.008
H <sub>E</sub>	1.50	1.60	1.70	0.061	0.063	0.065

- STYLE 4:  
PIN 1. CATHODE  
2. CATHODE  
3. ANODE

### SOLDERING FOOTPRINT\*

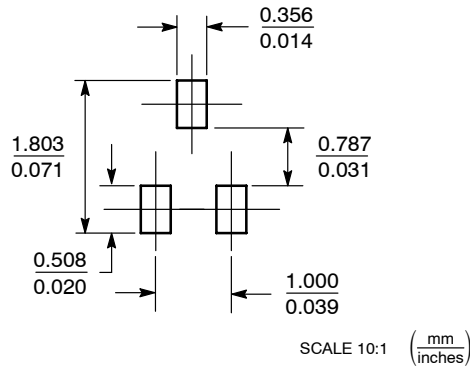

\*For additional information on our Pb-Free strategy and soldering details, please download the ON Semiconductor Soldering and Mounting Techniques Reference Manual, SOLDERRM/D.

ON Semiconductor and are registered trademarks of Semiconductor Components Industries, LLC (SCILLC). SCILLC reserves the right to make changes without further notice to any products herein. SCILLC makes no warranty, representation or guarantee regarding the suitability of its products for any particular purpose, nor does SCILLC assume any liability arising out of the application or use of any product or circuit, and specifically disclaims any and all liability, including without limitation special, consequential or incidental damages. "Typical" parameters which may be provided in SCILLC data sheets and/or specifications can and do vary in different applications and actual performance may vary over time. All operating parameters, including "Typicals" must be validated for each customer application by customer's technical experts. SCILLC does not convey any license under its patent rights nor the rights of others. SCILLC products are not designed, intended, or authorized for use as components in systems intended for surgical implant into the body, or other applications intended to support or sustain life, or for any other application in which the failure of the SCILLC product could create a situation where personal injury or death may occur. Should Buyer purchase or use SCILLC products for any such unintended or unauthorized application, Buyer shall indemnify and hold SCILLC and its officers, employees, subsidiaries, affiliates, and distributors harmless against all claims, costs, damages, and expenses, and reasonable attorney fees arising out of, directly or indirectly, any claim of personal injury or death associated with such unintended or unauthorized use, even if such claim alleges that SCILLC was negligent regarding the design or manufacture of the part. SCILLC is an Equal Opportunity/Affirmative Action Employer. This literature is subject to all applicable copyright laws and is not for resale in any manner.

### PUBLICATION ORDERING INFORMATION

**LITERATURE FULFILLMENT:**  
Literature Distribution Center for ON Semiconductor  
P.O. Box 5163, Denver, Colorado 80217 USA  
**Phone:** 303-675-2175 or 800-344-3860 Toll Free USA/Canada  
**Fax:** 303-675-2176 or 800-344-3867 Toll Free USA/Canada  
**Email:** orderlit@onsemi.com

**N. American Technical Support:** 800-282-9855 Toll Free  
USA/Canada  
**Europe, Middle East and Africa Technical Support:**  
Phone: 421 33 790 2910  
**Japan Customer Focus Center**  
Phone: 81-3-5773-3850

**ON Semiconductor Website:** [www.onsemi.com](http://www.onsemi.com)  
**Order Literature:** <http://www.onsemi.com/orderlit>  
For additional information, please contact your local Sales Representative

# Mouser Electronics

Authorized Distributor

Click to View Pricing, Inventory, Delivery & Lifecycle Information:

[ON Semiconductor:](#)

[NZL5V6ATT1G](#)