

# 4V Drive Nch MOSFET

## RSD050N06

### ●Structure

Silicon N-channel MOSFET

### ●Features

- 1) Low on-resistance.
- 2) Fast switching speed.
- 3) Drive circuits can be simple.
- 3) Parallel use is easy.

### ●Applications

Switching

### ●Packaging specifications

Type	Package	CPT3
	Code	TL
	Basic ordering unit (pieces)	2500

### ●Absolute maximum ratings (T<sub>a</sub>=25°C)

Parameter	Symbol	Limits	Unit
Drain-source voltage	V <sub>DSS</sub>	60	V
Gate-source voltage	V <sub>GSS</sub>	±20	V
Drain current	Continuous	I <sub>D</sub>	±5.0 A
	Pulsed	I <sub>DP</sub> *1	±15 A
Source current (Body Diode)	Continuous	I <sub>S</sub>	5.0 A
	Pulsed	I <sub>SP</sub> *1	15 A
Power dissipation	P <sub>D</sub> *2	15	W
Channel temperature	T <sub>ch</sub>	150	°C
Range of storage temperature	T <sub>stg</sub>	-55 to +150	°C

\*1 P<sub>w</sub>≤10μs, Duty cycle≤1%

\*2 T<sub>c</sub>=25°C

### ●Thermal resistance

Parameter	Symbol	Limits	Unit
Channel to Case	R <sub>th(ch-c)</sub> *	8.33	°C / W

\* T<sub>c</sub>=25°C

### ●Dimensions (Unit : mm)

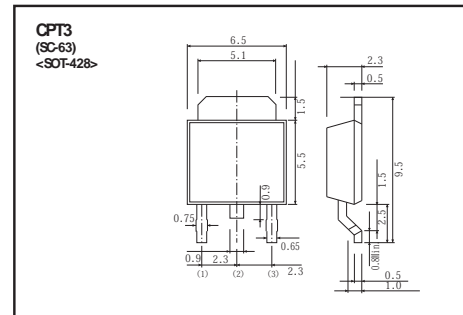

### ●Inner circuit

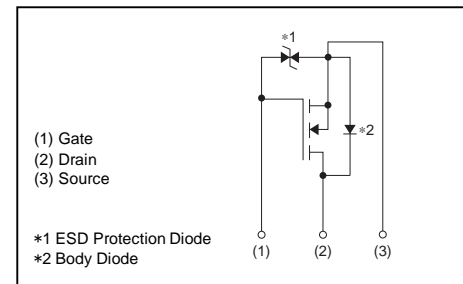

- (1) Gate
- (2) Drain
- (3) Source

- \*1 ESD Protection Diode
- \*2 Body Diode

**●Electrical characteristics (T<sub>a</sub>=25°C)**

Parameter	Symbol	Min.	Typ.	Max.	Unit	Conditions
Gate-source leakage	I <sub>GSS</sub>	-	-	±10	μA	V <sub>GS</sub> =±20V, V <sub>DS</sub> =0V
Drain-source breakdown voltage	V <sub>(BR)DSS</sub>	60	-	-	V	I <sub>D</sub> =1mA, V <sub>GS</sub> =0V
Zero gate voltage drain current	I <sub>DSS</sub>	-	-	1	μA	V <sub>DS</sub> =60V, V <sub>GS</sub> =0V
Gate threshold voltage	V <sub>GS(th)</sub>	1.0	-	3.0	V	V <sub>DS</sub> =10V, I <sub>D</sub> =1mA
Static drain-source on-state resistance	R <sub>DS(on)</sub> *	-	78	109	mΩ	I <sub>D</sub> =5.0A, V <sub>GS</sub> =10V
		-	94	131		I <sub>D</sub> =5.0A, V <sub>GS</sub> =4.5V
		-	100	140		I <sub>D</sub> =5.0A, V <sub>GS</sub> =4.0V
Forward transfer admittance	Y <sub>fs</sub>  *	3.5	-	-	S	I <sub>D</sub> =5.0A, V <sub>DS</sub> =10V
Input capacitance	C <sub>ISS</sub>	-	290	-	pF	V <sub>DS</sub> =10V
Output capacitance	C <sub>OSS</sub>	-	90	-	pF	V <sub>GS</sub> =0V
Reverse transfer capacitance	C <sub>RSS</sub>	-	35	-	pF	f=1MHz
Turn-on delay time	t <sub>d(on)</sub> *	-	8	-	ns	I <sub>D</sub> =2.5A, V <sub>DD</sub> =30V
Rise time	t <sub>r</sub> *	-	17	-	ns	V <sub>GS</sub> =10V
Turn-off delay time	t <sub>d(off)</sub> *	-	26	-	ns	R <sub>L</sub> =12Ω
Fall time	t <sub>f</sub> *	-	8	-	ns	R <sub>G</sub> =10Ω
Total gate charge	Q <sub>g</sub> *	-	8.0	-	nC	V <sub>DD</sub> =30V
Gate-source charge	Q <sub>gs</sub> *	-	1.4	-	nC	I <sub>D</sub> =5.0A
Gate-drain charge	Q <sub>gd</sub> *	-	1.4	-	nC	V <sub>GS</sub> =10V

\*Pulsed

**●Body diode characteristics (Source-Drain) (T<sub>a</sub>=25°C)**

Parameter	Symbol	Min.	Typ.	Max.	Unit	Conditions
Forward Voltage	V <sub>SD</sub> *	-	-	1.2	V	I <sub>s</sub> =5.0A, V <sub>GS</sub> =0V

\*Pulsed

●Electrical characteristic curves (Ta=25°C)

Fig.1 Typical Output Characteristics ( I )

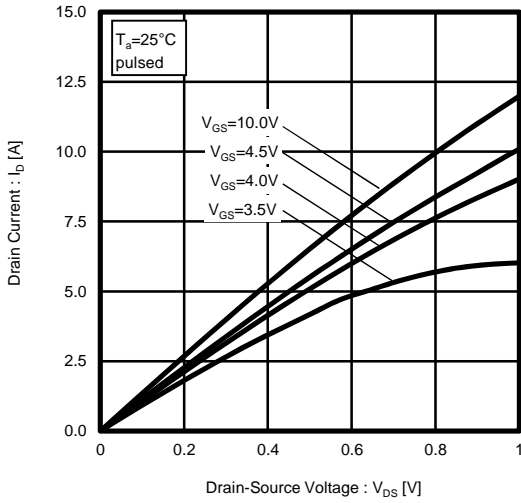

Fig.2 Typical Output Characteristics ( II )

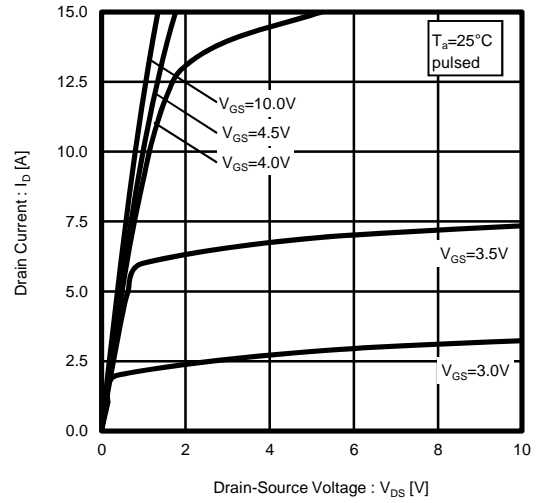

Fig.3 Static Drain-Source On-State Resistance vs. Drain Current

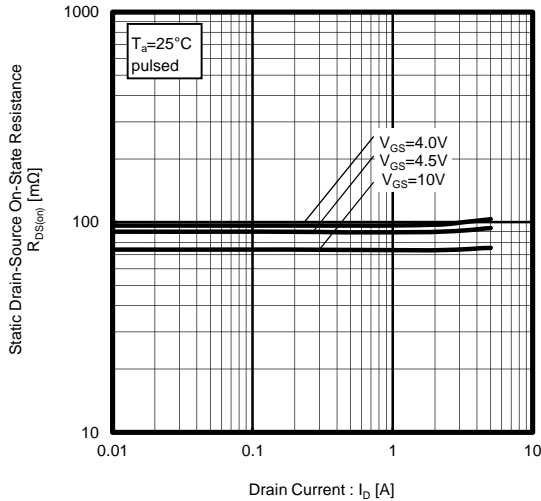

Fig.4 Static Drain-Source On-State Resistance vs. Drain Current

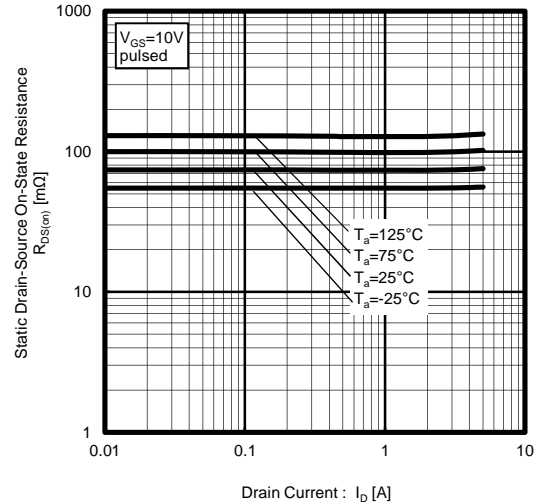

Fig.5 Static Drain-Source On-State Resistance vs. Drain Current

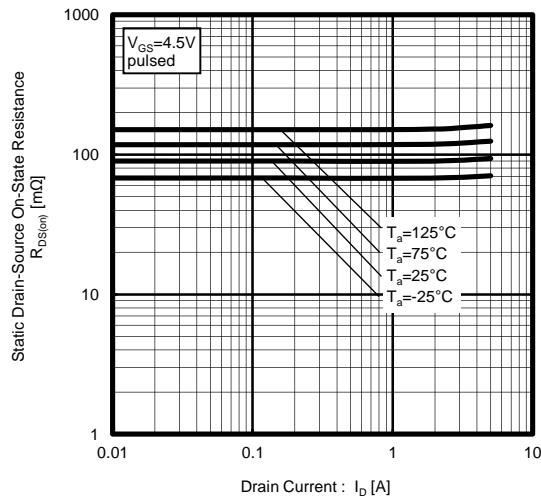

Fig.6 Static Drain-Source On-State Resistance vs. Drain Current

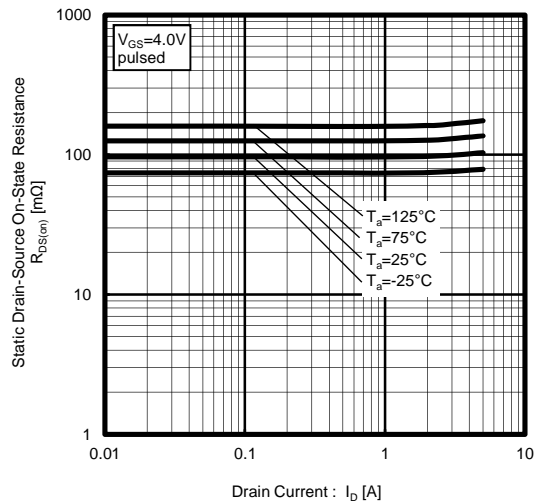

Fig.7 Forward Transfer Admittance vs. Drain Current

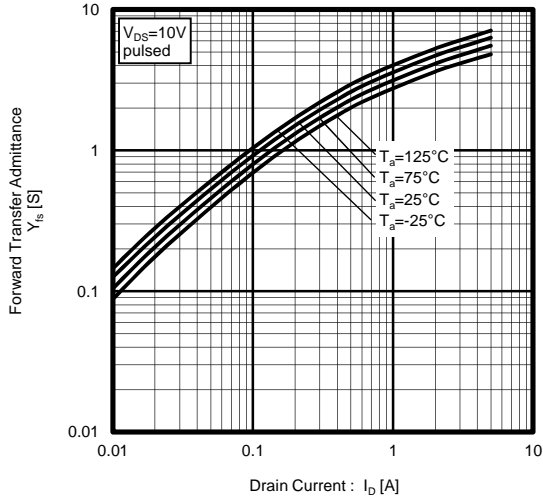

Fig.8 Typical Transfer Characteristics

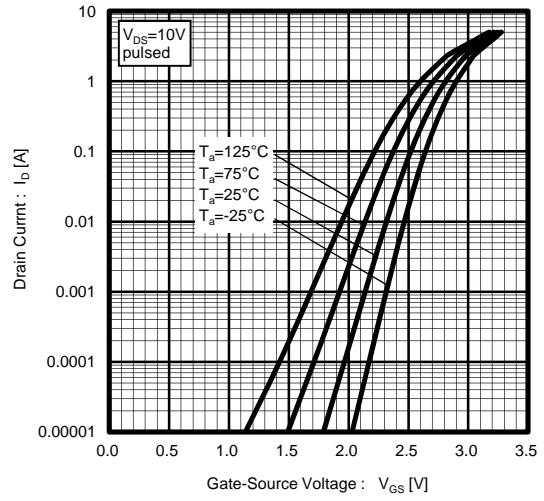

Fig.9 Source Current vs. Source-Drain Voltage

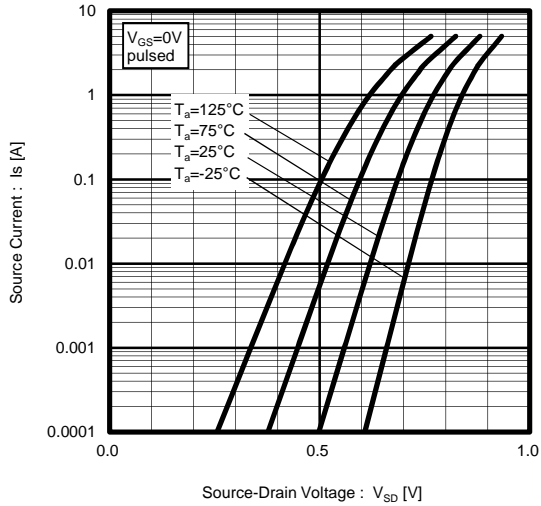

Fig.10 Static Drain-Source On-State Resistance vs. Gate-Source Voltage

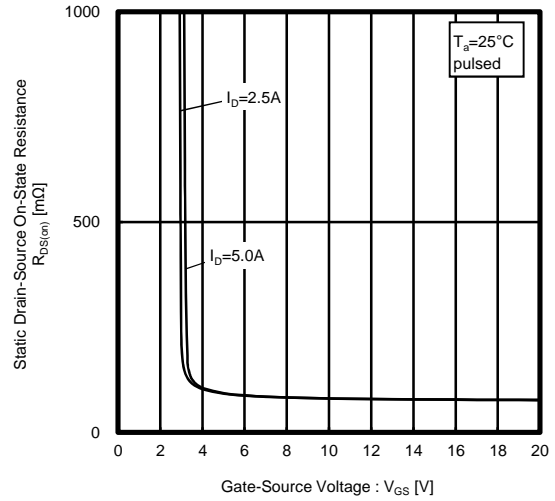

Fig.11 Switching Characteristics

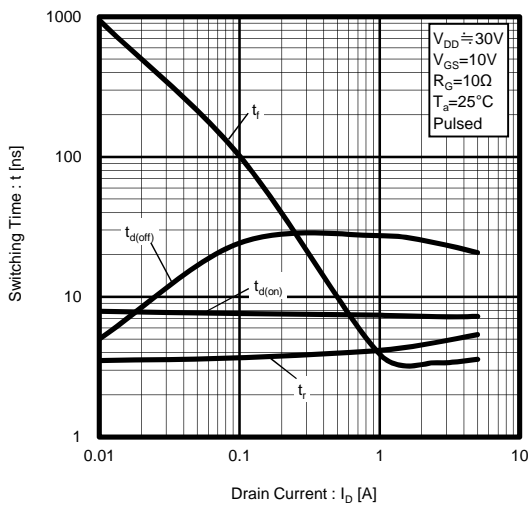

Fig.12 Dynamic Input Characteristics

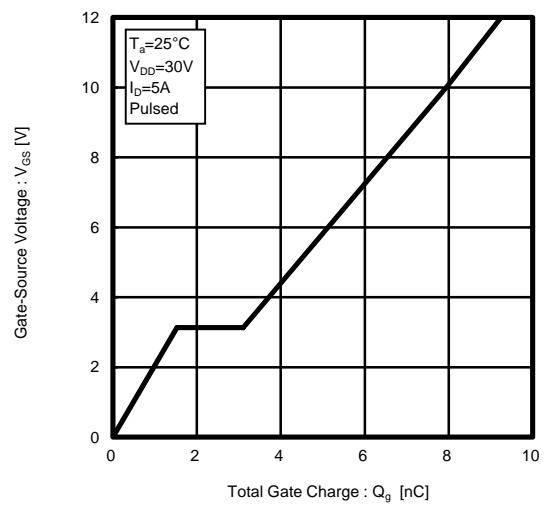

Fig.13 Typical Capacitance vs. Drain-Source Voltage

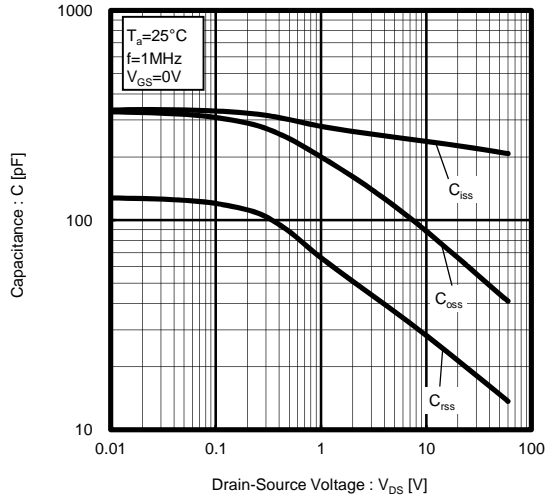

Fig.14 Maximum Safe Operating Area

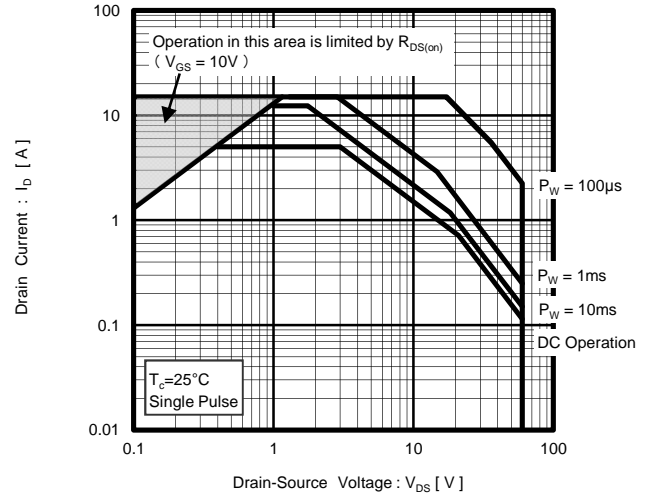
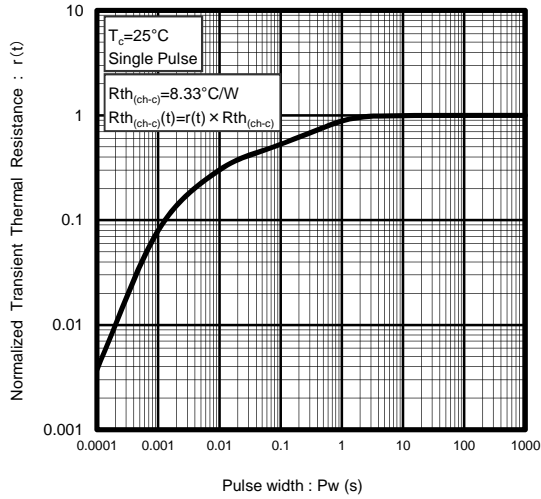

Fig.15 Normalized Transient Thermal Resistance v.s. Pulse Width



●Measurement circuits

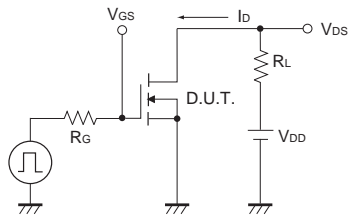

Fig.1-1 Switching Time Measurement Circuit

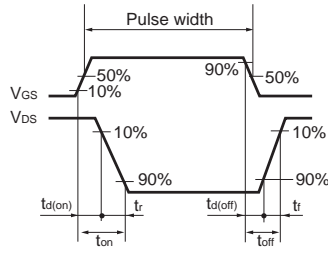

Fig.1-2 Switching Waveforms

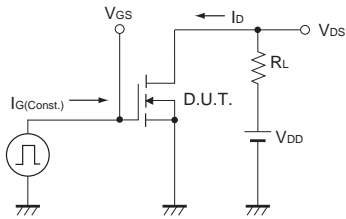

Fig.2-1 Gate Charge Measurement Circuit

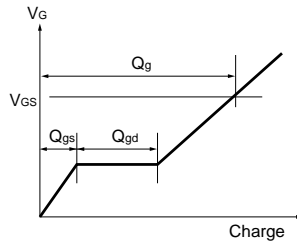

Fig.2-2 Gate Charge Waveform

# Mouser Electronics

Authorized Distributor

Click to View Pricing, Inventory, Delivery & Lifecycle Information:

[ROHM Semiconductor:](#)

[RSD050N06TL](#)