

Low drop power Schottky rectifier

Features

- Very small conduction losses
- Negligible switching losses
- Low forward voltage drop
- Surface mount miniature package
- Avalanche capability specified
- ECOPACK2[®] halogen-free component (SMAflat and SMBflat)

Description

Single chip Schottky rectifiers suited to Switched Mode Power Supplies and high frequency DC to DC converters.

Packaged in SMB, low profile SMB and low profile SMA, this device is especially intended for surface mounting and used in low voltage, high frequency inverters, free wheeling and polarity protection applications.

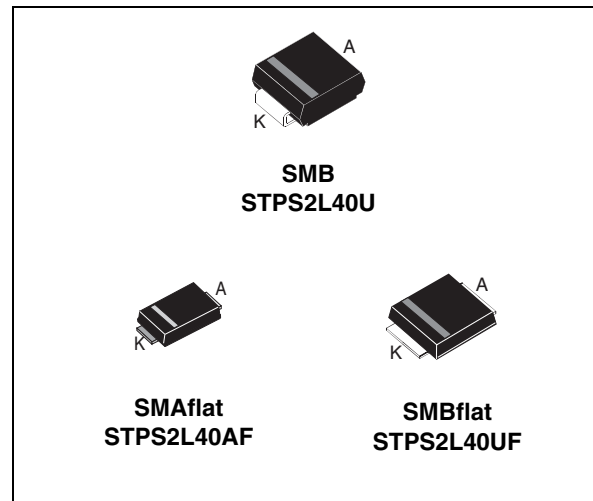

Table 1. Device summary

$I_{F(AV)}$	2 A
V_{RRM}	40 V
T_j (max)	150 °C
V_F (max)	0.34 V

1 Characteristics

Table 2. Absolute ratings (limiting values)

Symbol	Parameter		Value	Unit	
V_{RRM}	Repetitive peak reverse voltage		40	V	
$I_{F(AV)}$	Average forward current	SMB $T_L = 130\text{ °C } \delta = 0.5$	2	A	
		SMBflat $T_L = 140\text{ °C } \delta = 0.5$			
		SMAflat $T_L = 130\text{ °C } \delta = 0.5$			
I_{FSM}	Surge non repetitive forward current	$t_p = 10\text{ ms}$ sinusoidal	75	A	
P_{ARM}	Repetitive peak avalanche power		$t_p = 1\text{ }\mu\text{s } T_j = 25\text{ °C}$	2200	W
T_{stg}	Storage temperature range		-65 to + 150	°C	
T_j	Operating junction temperature ⁽¹⁾		150	°C	

1. $\frac{dP_{tot}}{dT_j} < \frac{1}{R_{th(j-a)}}$ condition to avoid thermal runaway for a diode on its own heatsink

Table 3. Thermal resistances

Symbol	Parameter		Value	Unit
$R_{th(j-l)}$	Junction to lead	SMB	20	°C/W
		SMBflat	10	
		SMAflat	20	

Table 4. Static electrical characteristics

Symbol	Tests conditions		Min.	Typ.	Max.	Unit
$I_R^{(1)}$	Reverse leakage current	$T_j = 25\text{ °C}$	$V_R = 40\text{ V}$		220	μA
		$T_j = 100\text{ °C}$			20	mA
		$T_j = 125\text{ °C}$		38	80	mA
$V_F^{(1)}$	Forward voltage drop	$T_j = 25\text{ °C}$	$I_F = 1\text{ A}$		0.39	V
		$T_j = 125\text{ °C}$		0.25	0.28	
		$T_j = 25\text{ °C}$	$I_F = 2\text{ A}$		0.43	V
		$T_j = 125\text{ °C}$		0.31	0.34	
		$T_j = 25\text{ °C}$	$I_F = 4\text{ A}$		0.5	V
		$T_j = 125\text{ °C}$		0.39	0.45	

1. Pulse test: $t_p = 380\text{ }\mu\text{s}, \delta < 2$

To evaluate the conduction losses use the following equation:

$$P = 0.22 \times I_{F(AV)} + 0.06 I_{F(RMS)}^2$$

Figure 1. Average forward power dissipation versus average forward current

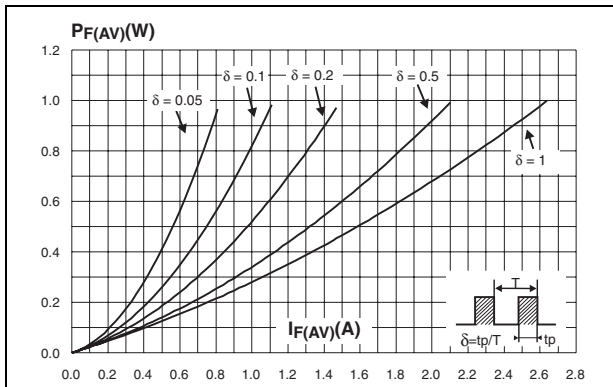

Figure 2. Average forward current versus ambient temperature (delta = 0.5) SMB

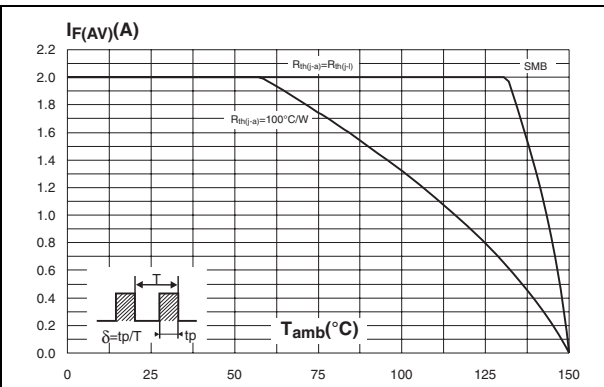

Figure 3. Average forward current versus ambient temperature (delta = 0.5) SMBflat

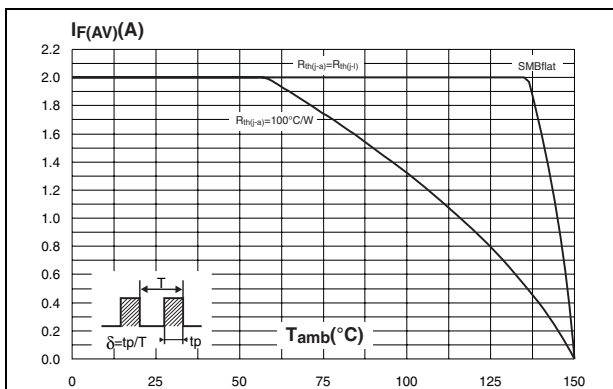

Figure 4. Average forward current versus ambient temperature (delta = 0.5) SMAflat

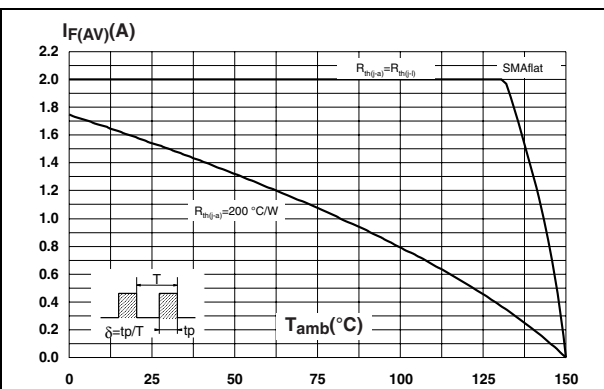

Figure 5. Non repetitive surge peak forward current versus overload duration (maximum values) SMB

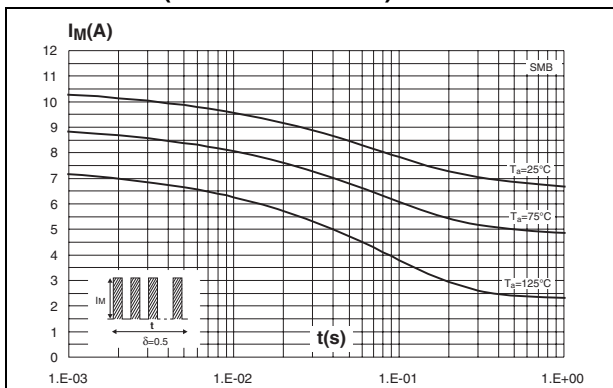

Figure 6. Non repetitive surge peak forward current versus overload duration (maximum values) SMBflat

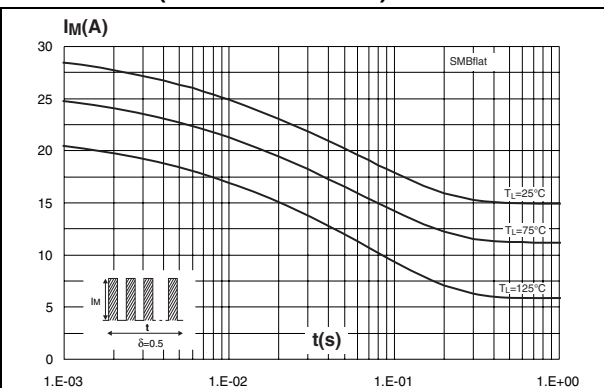

Figure 7. Non repetitive surge peak forward current versus overload duration (maximum values) SMAflat

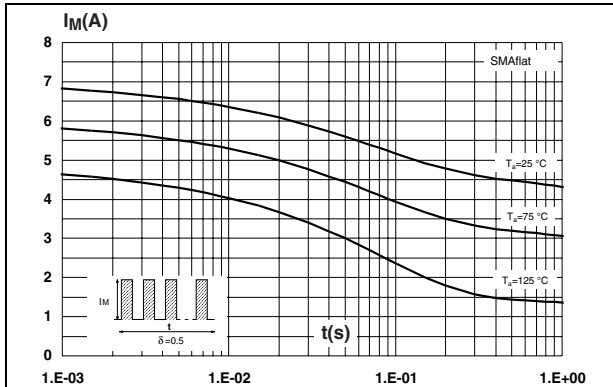

Figure 8. Normalized avalanche power derating versus pulse duration

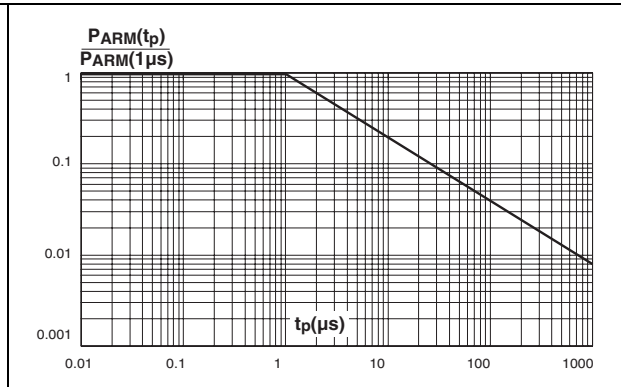

Figure 9. Normalized avalanche power derating versus junction temperature

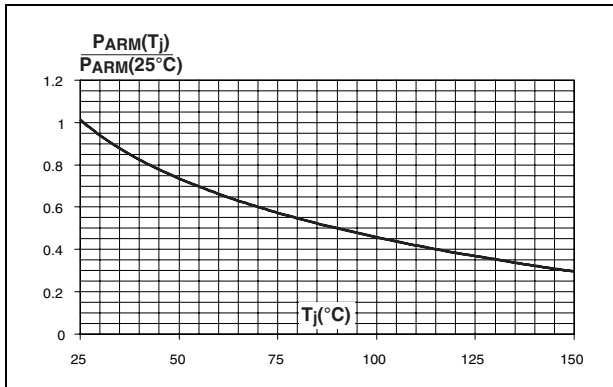

Figure 10. Relative variation of thermal impedance junction to ambient versus pulse duration - SMB

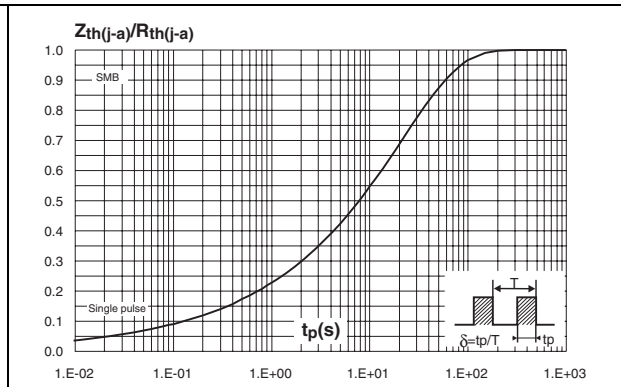

Figure 11. Relative variation of thermal impedance junction to lead versus pulse duration - SMBflat

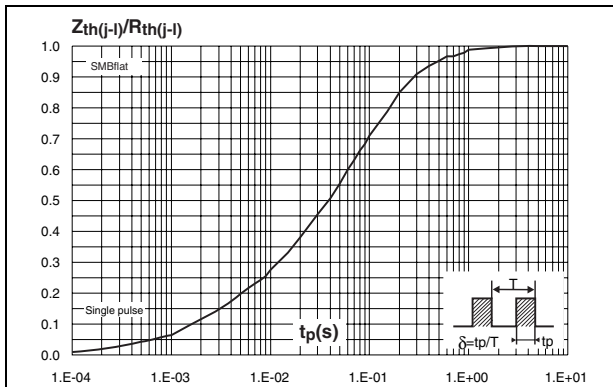

Figure 12. Relative variation of thermal impedance junction to ambient versus pulse duration - SMAflat

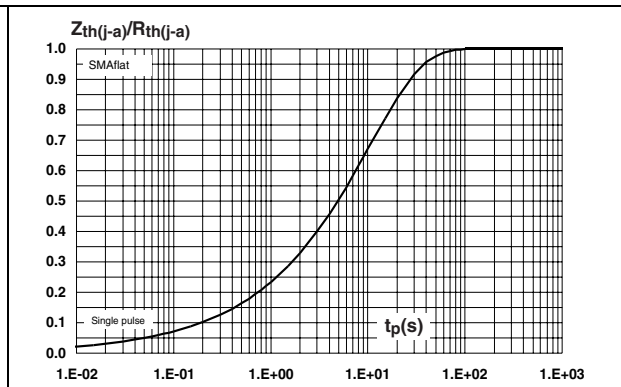

Figure 13. Reverse leakage current versus reverse voltage applied (typical values)

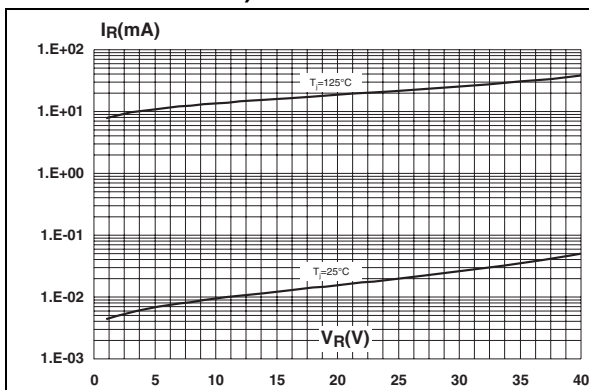

Figure 14. Junction capacitance versus reverse voltage applied (typical values)

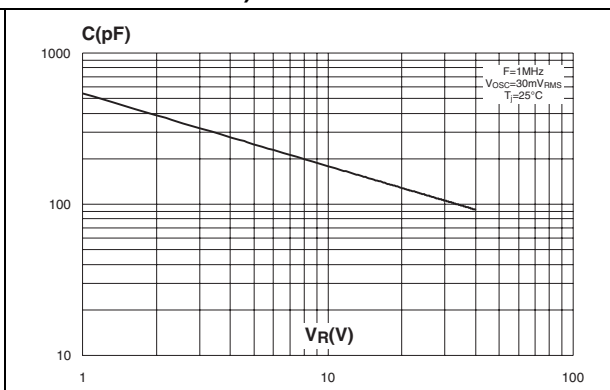

Figure 15. Forward voltage drop versus forward current (high level)

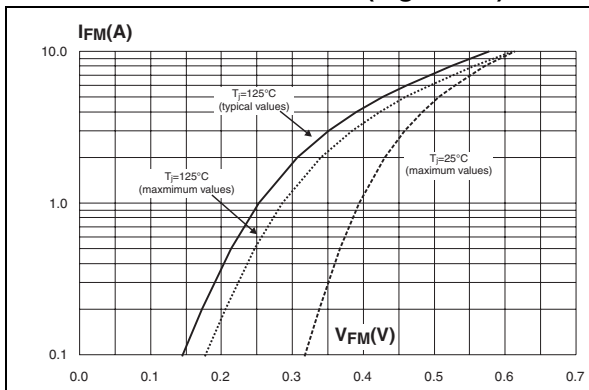

Figure 16. Forward voltage drop versus forward current (low level)

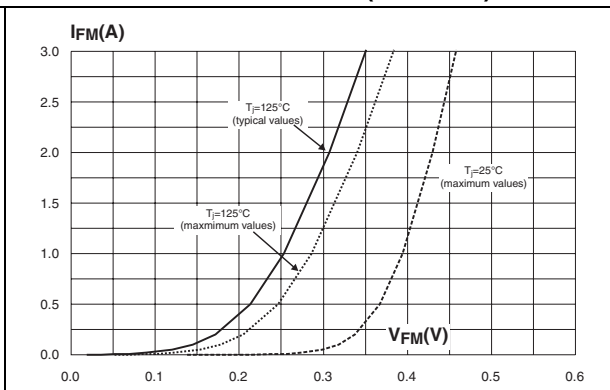

Figure 17. Thermal resistance junction to ambient versus copper surface under each lead, SMB, SMBflat (epoxy printed board FR4, copper thickness = 35 μm)

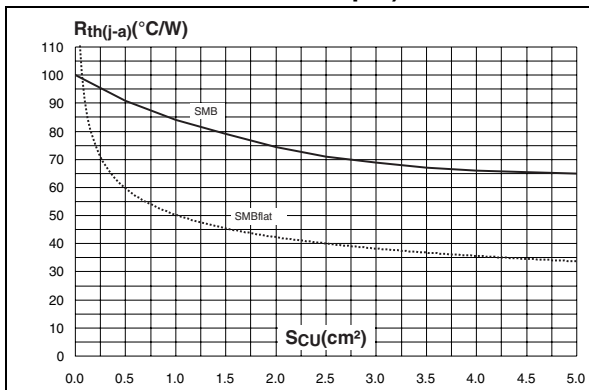
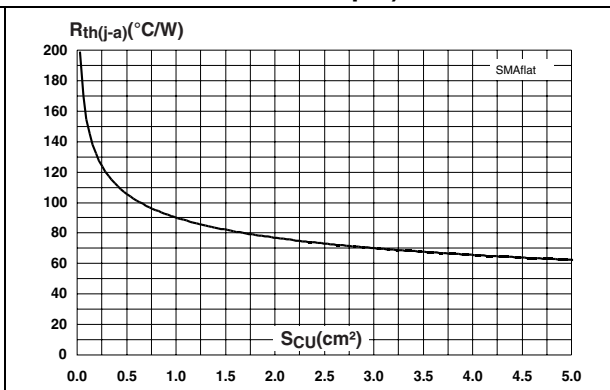

Figure 18. Thermal resistance junction to ambient versus copper surface under each lead, SMAflat (epoxy printed board FR4, copper thickness = 35 μm)



2 Package Information

- Epoxy meets UL94,V0

In order to meet environmental requirements, ST offers these devices in ECOPACK® packages. These packages have a lead-free second level interconnect. The category of second level interconnect is marked on the package and on the inner box label, in compliance with JEDEC Standard JESD97. The maximum ratings related to soldering conditions are also marked on the inner box label. ECOPACK is an ST trademark. ECOPACK specifications are available at www.st.com.

Table 5. SMB dimensions

Ref.	Dimensions			
	Millimeters		Inches	
	Min.	Max.	Min.	Max.
A1	1.90	2.45	0.075	0.096
A2	0.05	0.20	0.002	0.008
b	1.95	2.20	0.077	0.087
c	0.15	0.40	0.006	0.016
E	5.10	5.60	0.201	0.220
E1	4.05	4.60	0.159	0.181
D	3.30	3.95	0.130	0.156
L	0.75	1.50	0.030	0.059

Figure 19. SMB footprint dimensions in millimeters (inches)

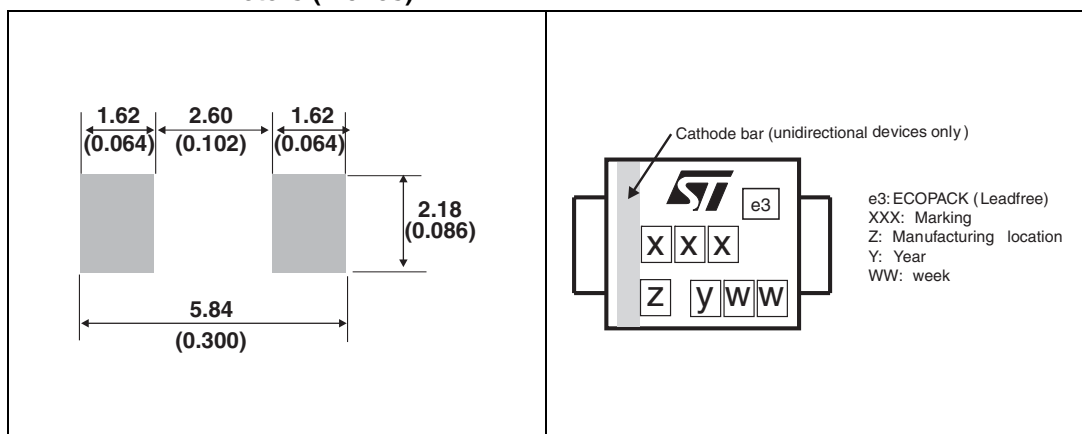

Figure 20. Marking information

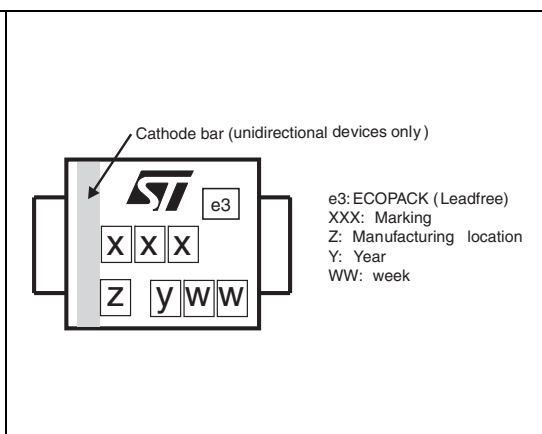
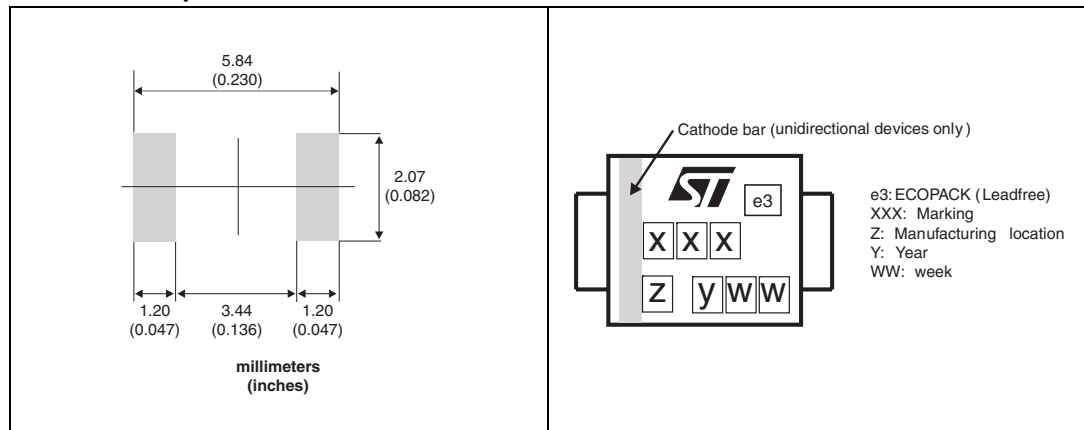

Table 6. SMBflat dimensions

Ref.	Dimensions					
	Millimeters			Inches		
	Min.	Typ.	Max.	Min.	Typ.	Max.
A	0.90		1.10	0.035		0.043
b ⁽¹⁾	1.95		2.20	0.077		0.087
c ⁽¹⁾	0.15		0.40	0.006		0.016
D	3.30		3.95	0.130		0.156
E	5.10		5.60	0.200		0.220
E1	4.05		4.60	0.189		0.181
L	0.75		1.50	0.029		0.059
L1		0.40			0.016	
L2		0.60			0.024	

1. Applies to plated leads

Figure 21. SMBflat footprint dimensions **Figure 22. Marking information optimized for SMBflat⁽¹⁾**



1. SMB footprint may also be used.

3 Ordering Information

Table 8. Ordering information

Order code	Marking	Package	Weight	Base qty	Delivery mode
STPS2L40U	GD4	SMB	0.107 g	2500	Tape and reel
STPS2L40UF	FGD4	SMBflat	0.50 g	5000	Tape and reel
STPS2L40AF	F2L4	SMAflat	0.35 g	10000	Tape and reel

4 Revision history

Table 9. Document revision history

Date	Revision	Description of changes
Jul-2003	2A	Last update.
31-Jan-2007	3	Reformatted to current standard. Added ECOPACK statement. Added SMBflat package.
18-Sep-2008	4	Reformatted to current standard. Updated ECOPACK statement. Added SMAflat package.

Please Read Carefully:

Information in this document is provided solely in connection with ST products. STMicroelectronics NV and its subsidiaries ("ST") reserve the right to make changes, corrections, modifications or improvements, to this document, and the products and services described herein at any time, without notice.

All ST products are sold pursuant to ST's terms and conditions of sale.

Purchasers are solely responsible for the choice, selection and use of the ST products and services described herein, and ST assumes no liability whatsoever relating to the choice, selection or use of the ST products and services described herein.

No license, express or implied, by estoppel or otherwise, to any intellectual property rights is granted under this document. If any part of this document refers to any third party products or services it shall not be deemed a license grant by ST for the use of such third party products or services, or any intellectual property contained therein or considered as a warranty covering the use in any manner whatsoever of such third party products or services or any intellectual property contained therein.

UNLESS OTHERWISE SET FORTH IN ST'S TERMS AND CONDITIONS OF SALE ST DISCLAIMS ANY EXPRESS OR IMPLIED WARRANTY WITH RESPECT TO THE USE AND/OR SALE OF ST PRODUCTS INCLUDING WITHOUT LIMITATION IMPLIED WARRANTIES OF MERCHANTABILITY, FITNESS FOR A PARTICULAR PURPOSE (AND THEIR EQUIVALENTS UNDER THE LAWS OF ANY JURISDICTION), OR INFRINGEMENT OF ANY PATENT, COPYRIGHT OR OTHER INTELLECTUAL PROPERTY RIGHT.

UNLESS EXPRESSLY APPROVED IN WRITING BY AN AUTHORIZED ST REPRESENTATIVE, ST PRODUCTS ARE NOT RECOMMENDED, AUTHORIZED OR WARRANTED FOR USE IN MILITARY, AIR CRAFT, SPACE, LIFE SAVING, OR LIFE SUSTAINING APPLICATIONS, NOR IN PRODUCTS OR SYSTEMS WHERE FAILURE OR MALFUNCTION MAY RESULT IN PERSONAL INJURY, DEATH, OR SEVERE PROPERTY OR ENVIRONMENTAL DAMAGE. ST PRODUCTS WHICH ARE NOT SPECIFIED AS "AUTOMOTIVE GRADE" MAY ONLY BE USED IN AUTOMOTIVE APPLICATIONS AT USER'S OWN RISK.

Resale of ST products with provisions different from the statements and/or technical features set forth in this document shall immediately void any warranty granted by ST for the ST product or service described herein and shall not create or extend in any manner whatsoever, any liability of ST.

ST and the ST logo are trademarks or registered trademarks of ST in various countries.

Information in this document supersedes and replaces all information previously supplied.

The ST logo is a registered trademark of STMicroelectronics. All other names are the property of their respective owners.

© 2008 STMicroelectronics - All rights reserved

STMicroelectronics group of companies

Australia - Belgium - Brazil - Canada - China - Czech Republic - Finland - France - Germany - Hong Kong - India - Israel - Italy - Japan - Malaysia - Malta - Morocco - Singapore - Spain - Sweden - Switzerland - United Kingdom - United States of America

www.st.com

Mouser Electronics

Authorized Distributor

Click to View Pricing, Inventory, Delivery & Lifecycle Information:

[STMicroelectronics:](#)

[STPS2L40U](#) [STPS2L40UF](#) [STPS2L40AF](#)