

HF/VHF/UHF RF power N-channel MOSFETs

Features

- Gold metallization
- Excellent thermal stability
- Common source configuration, push pull
- $P_{OUT} = 350\text{ W}$ min. with 15 db gain @ 175 MHz
- Low $R_{DS(on)}$

Description

The SD2942 is a gold metallized N-channel MOS field-effect RF power transistor. The SD2942 offers 25% lower $R_{DS(ON)}$ than industry standard and 20% higher power saturation than ST SD2932. These characteristics make the SD2942 ideal for 50 V DC very high power applications up to 250 MHz.

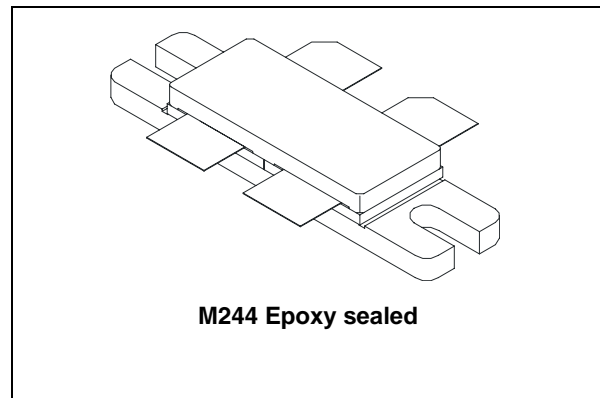

Figure 1. Pin connection

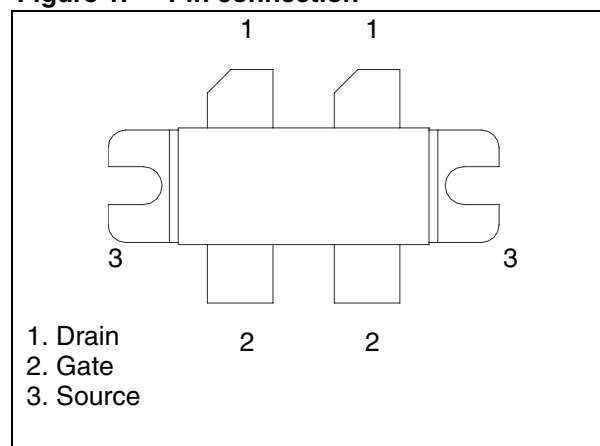

Table 1. Device summary

Order code	Marking	Base qty.	Package	Packaging
SD2942W	SD2942 ⁽¹⁾	15	M244	Tube

1. For more details please refer to [Chapter 7: Marking, packing and shipping specifications](#).

Content

1	Electrical data	3
1.1	Maximum rating	3
1.2	Thermal data	3
2	Electrical characteristics	4
3	Impedance	5
4	Typical performance	6
5	Test circuit	10
6	Package mechanical data	13
7	Marking, packing and shipping specifications	15
8	Revision history	16

1 Electrical data

1.1 Maximum rating

$$T_{\text{CASE}} = 25^{\circ}\text{C}$$

Table 2. Absolute maximum rating

Symbol	Parameter	Value	Unit
$V_{(\text{BR})\text{DSS}}^{(1)}$	Drain-source voltage	130	V
$V_{\text{DGR}}^{(1)}$	Drain-gate voltage ($R_{\text{GS}} = 1\text{M}\Omega$)	130	V
V_{GS}	Gate-source voltage	± 20	V
I_{D}	Drain current	40	A
P_{DISS}	Power dissipation	500	W
T_{J}	Max. operating junction temperature	+200	$^{\circ}\text{C}$
T_{STG}	Storage temperature	-65 to +150	$^{\circ}\text{C}$

1. $T_{\text{J}} = 150^{\circ}\text{C}$

1.2 Thermal data

Table 3. Thermal data

Symbol	Parameter	Value	Unit
R_{thJC}	Junction to case thermal resistance	0.35	$^{\circ}\text{C}/\text{W}$

2 Electrical characteristics

$T_{CASE} = 25^{\circ}C$

Table 4. Static (per section)

Symbol	Test conditions		Min.	Typ.	Max.	Unit
$V_{(BR)DSS}^{(1)}$	$V_{GS} = 0\text{ V}$	$I_{DS} = 100\text{ mA}$	130			V
I_{DSS}	$V_{GS} = 0\text{ V}$	$V_{DS} = 50\text{ V}$			100	μA
I_{GSS}	$V_{GS} = 20\text{ V}$	$V_{DS} = 0\text{ V}$			250	nA
$V_{GS(Q)}$	$V_{DS} = 10\text{ V}$	$I_D = 250\text{ mA}$	1.5		4	V
$V_{DS(ON)}$	$V_{GS} = 10\text{ V}$	$I_D = 10\text{ A}$			3.0	V
G_{FS}	$V_{DS} = 10\text{ V}$	$I_D = 5\text{ A}$	5			mho
C_{ISS}	$V_{GS} = 0\text{ V}$	$V_{DS} = 50\text{ V}$		415		pF
C_{OSS}	$V_{GS} = 0\text{ V}$	$V_{DS} = 50\text{ V}$		236		pF
C_{RSS}	$V_{GS} = 0\text{ V}$	$V_{DS} = 50\text{ V}$		17		pF

1. $T_J = 150^{\circ}C$

Table 5. Dynamic

Symbol	Test Conditions		Min.	Typ.	Max.	Unit
P_{OUT}	$V_{DD} = 50\text{ V}$	$I_{DQ} = 500\text{ mA}$ $f = 175\text{MHz}$	350			W
G_{PS}	$V_{DD} = 50\text{ V}$	$I_{DQ} = 500\text{ mA}$ $P_{OUT} = 350\text{ W}$ $f = 175\text{MHz}$	15	17		dB
η_D	$V_{DD} = 50\text{ V}$	$I_{DQ} = 500\text{ mA}$ $P_{OUT} = 350\text{ W}$ $f = 175\text{MHz}$	55	61		%
Load mismatch	$V_{DD} = 50\text{ V}$	$I_{DQ} = 500\text{ mA}$ $P_{OUT} = 350\text{ W}$ $f = 175\text{MHz}$ all phase angles	5:1			VSWR

3 Impedance

Figure 2. Impedance data schematic

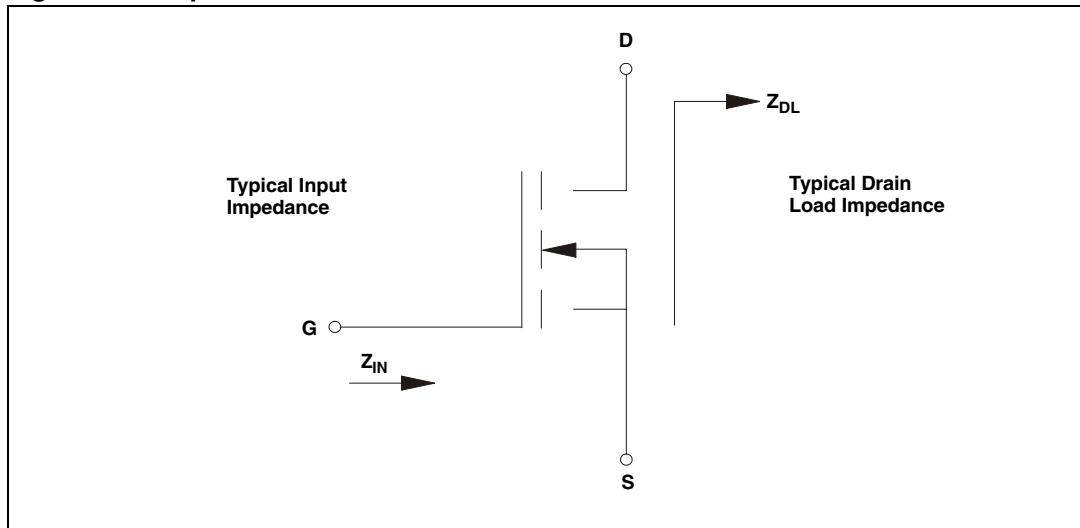

Table 6. Impedance data

f	Z_{IN} (Ω)	Z_{DL} (Ω)
250 MHz	$1.3 - j 1.9$	$1.9 + j 3.2$
230 MHz	$1.2 - j 1.8$	$2.1 + j 3.7$
200 MHz	$1.1 - j 1.6$	$2.7 + j 4.2$
175 MHz	$1.0 - j 1.4$	$3.3 + j 4.8$
100 MHz	$1.8 - j 2.5$	$7.5 + j 9$
50 MHz	$3.2 - j 4.4$	$10 + j 12$

4 Typical performance

Figure 3. Capacitance vs drain voltage

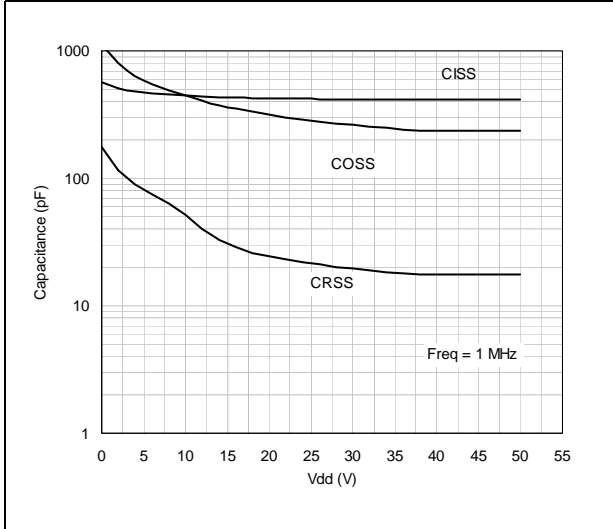

Figure 4. Drain current vs gate voltage

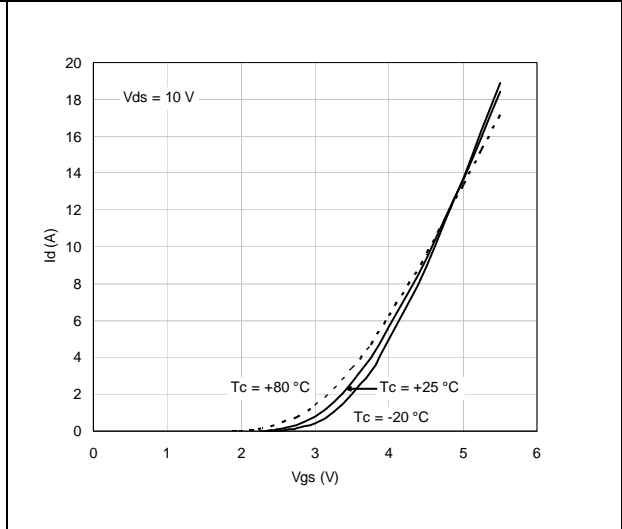

Figure 5. Gate-source voltage vs case temperature

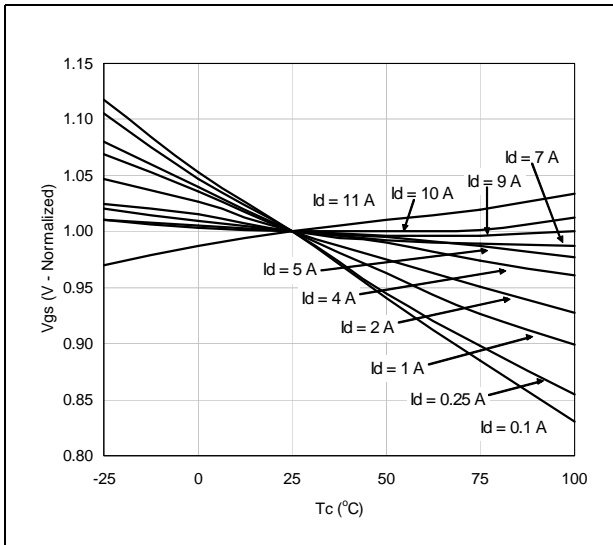

Figure 6. Power gain vs P_{OUT} and case temperature

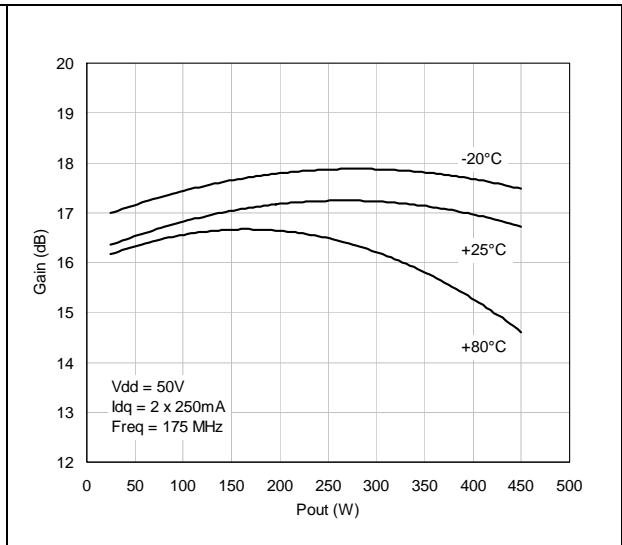

Figure 7. Efficiency vs case temperature

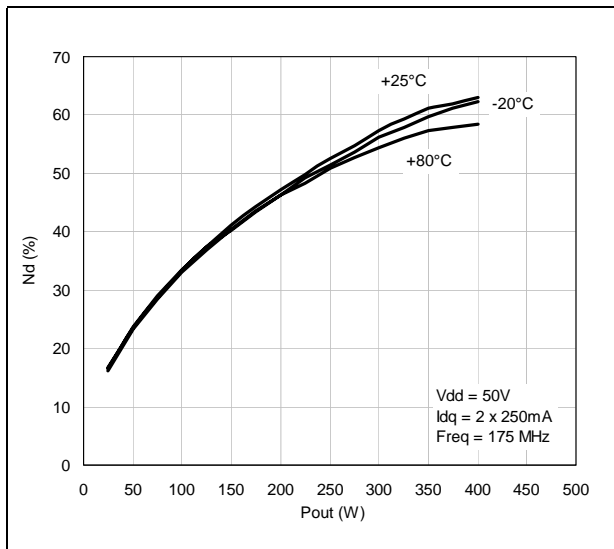

Figure 8. P_{OUT} vs input power and case temperature

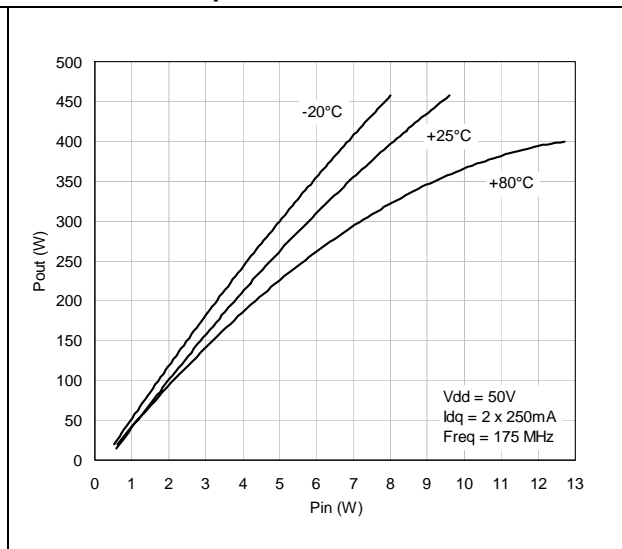

Figure 9. P_{OUT} vs input power and drain voltage

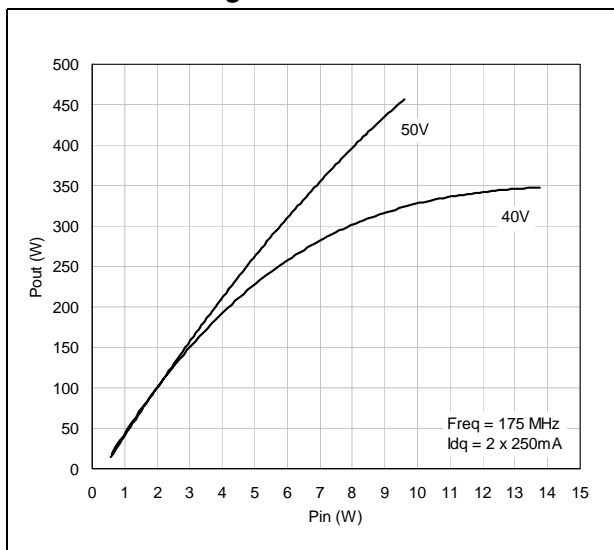

Figure 10. P_{OUT} vs gate voltage and case temperature

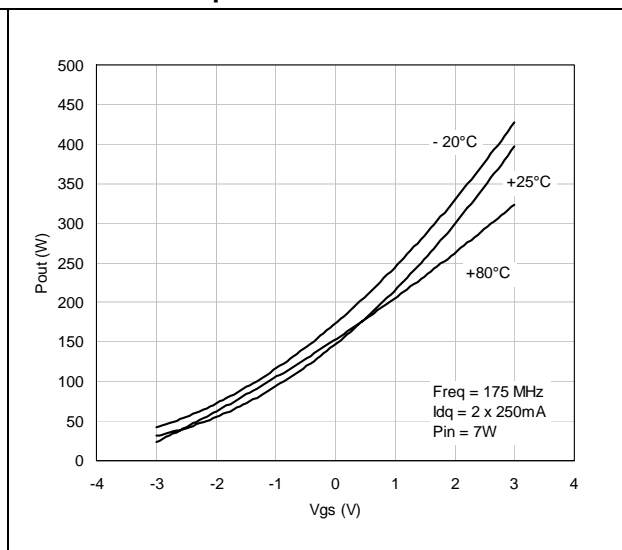

Figure 11. P_{OUT} vs drain voltage and input power

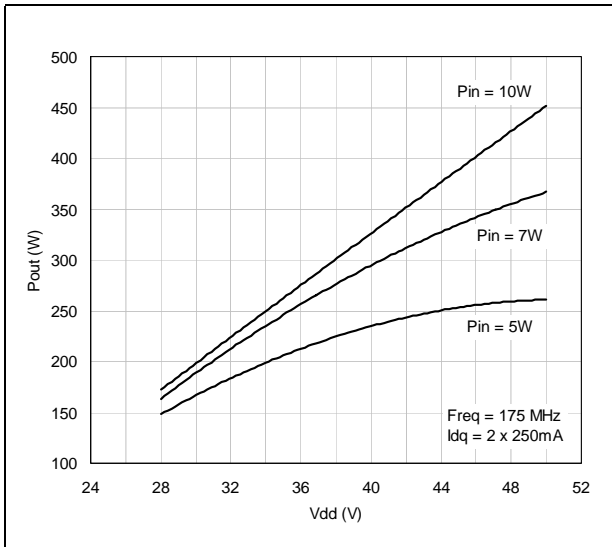

Figure 12. Maximum thermal resist vs case temperature

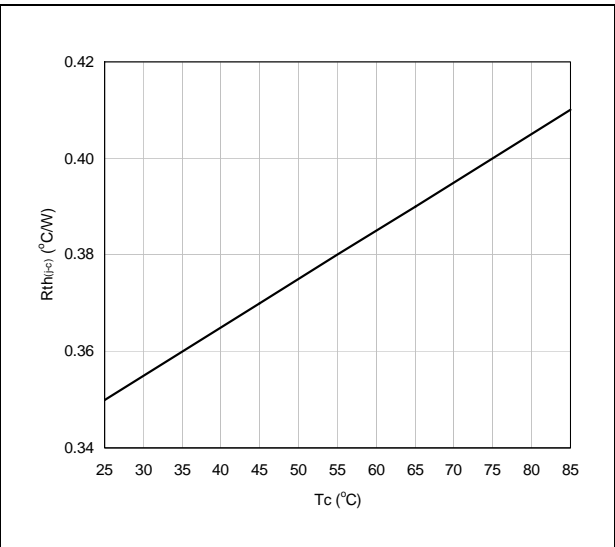

Figure 13. Maximum safe operating area

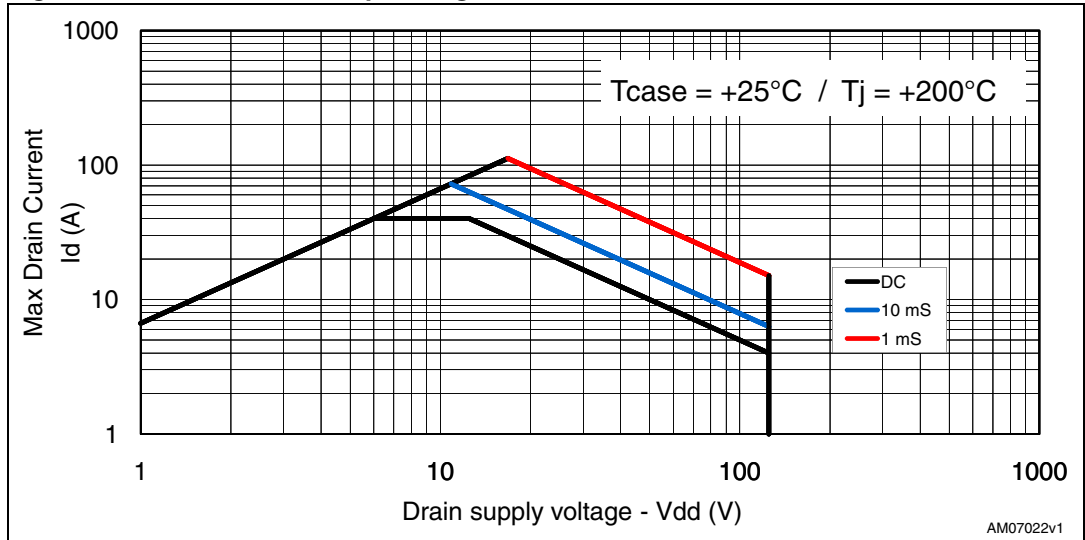

Figure 14. Transient thermal impedance

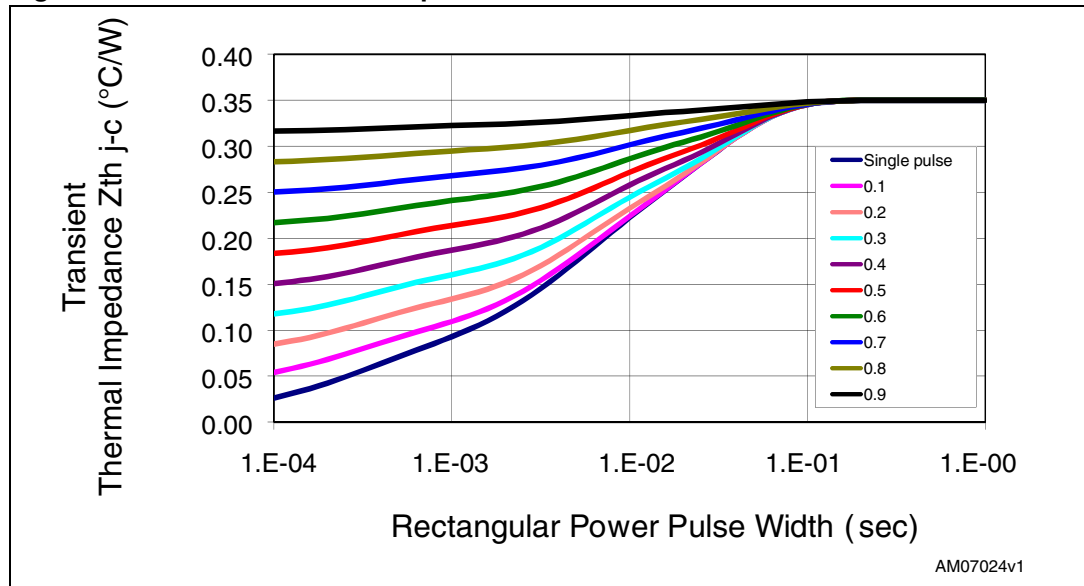
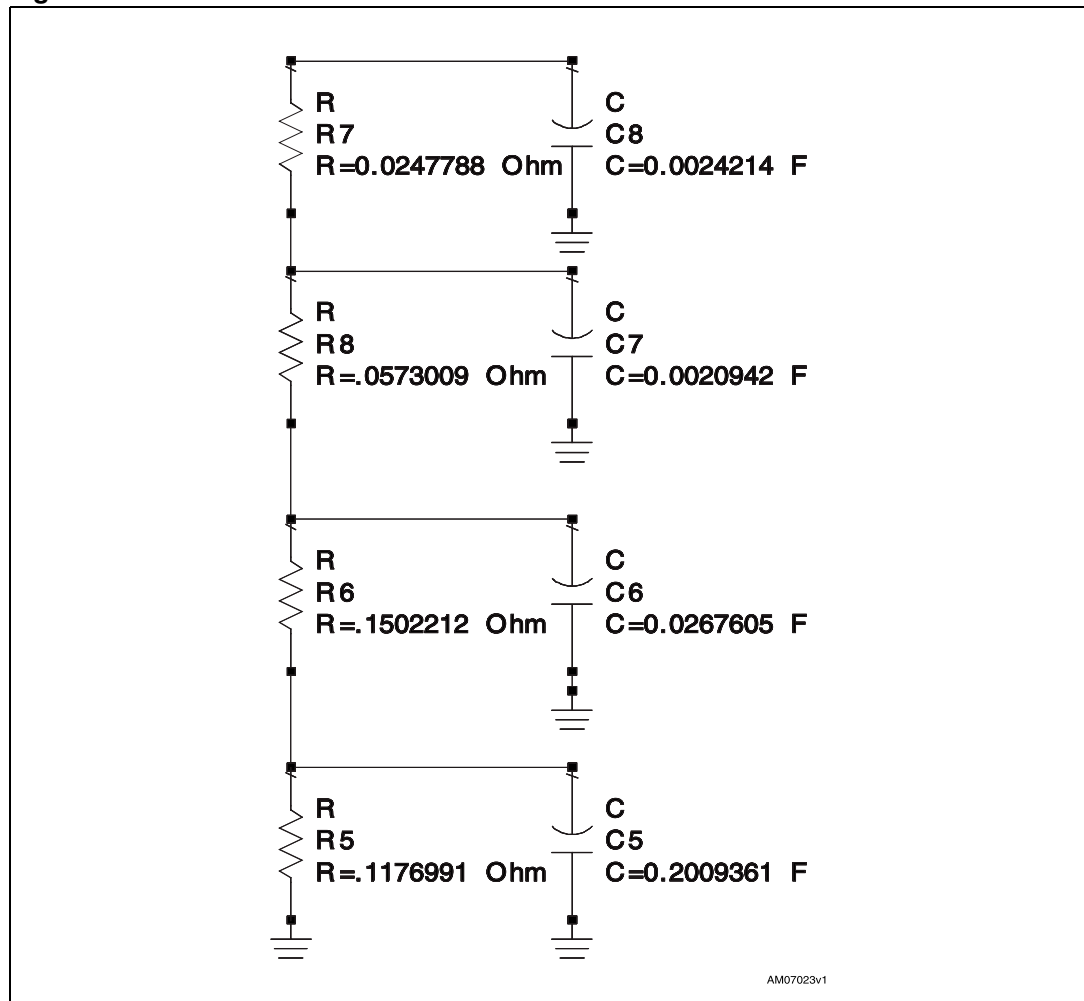
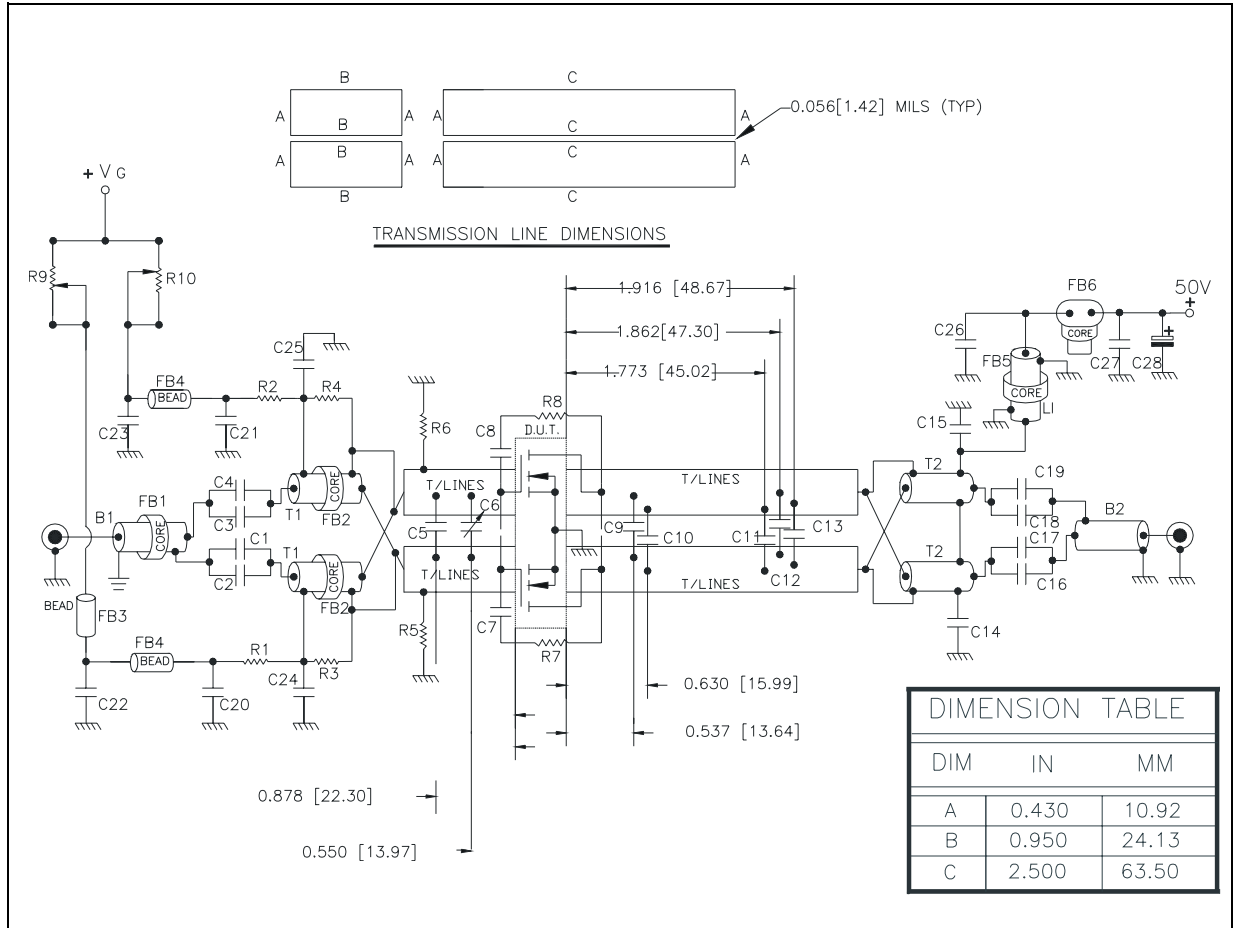

Figure 15. Transient thermal model



5 Test circuit

Figure 16. 175 MHz test circuit schematic



- Note: 1 Dimensions at component symbols are references for component placement.
 2 Gap between ground and transmission lines is + 0.002{0.05} - 0.000{0.00} Typ.

Table 7. 175 MHz test circuit component list

Symbol	Description
R1,R2,R5,R6	470 Ω 1 W, surface mount chip resistor
R3,R4	360 Ω 0.5 W, carbon comp. axial lead resistor or equivalent
R7,R8	560 Ω 2 W, resistor two turn wire air-wound axial lead resistor
R9,R10	20 K Ω 3.09 W, 10 turn wirewound precision potentiometer
C1,C4	680 pF ATC 130B surface mount ceramic chip capacitor
C2,C3,C7,C8,C17,C19,C20,C21	10000 pF ATC 200B surface mount ceramic chip capacitor
C5	75 pF ATC 100B surface mount ceramic chip capacitor
C6	ST40 25 pF - 115 pF miniature variable trimmer
C9,C10	47 pF ATC 100B surface mount ceramic chip capacitor
C11,C12, C13	43 pF ATC 100B surface mount ceramic chip capacitor
C14,C15,C24,C25	1200 pF ATC 700B surface mount ceramic chip capacitor
C16,C18	470 pF ATC 700B surface mount ceramic chip capacitor
C22,C23	0.1 μ F / 500 V surface mount ceramic chip capacitor
C26,C27	0.01 μ F / 500 V surface mount ceramic chip capacitor
C28	10 μ F / 63 aluminum electrolytic axial lead capacitor
B1	50 Ω RG316 O.D 0.076[1.93] L = 11.80[299.72] flexible coaxial cable 4 turns through ferrite bead
B2	50 Ω RG-142B O.D 0.165[4.19] L = 11.80[299.72] flexible coaxial cable
T1	R.F. transformer 4:1, 25 Ω O.D RG316-25 O.D 0.080[2.03] L = 5.90[149.86] flexible coaxial cable 2 turns through ferrite bead multi-aperture core
T2	R.F. transformer 1:4, 25 Ω semi-rigid coaxial cable O.D. 0.141[3.58] L = 5.90[149.86]
L1	Inductor λ 1/4 wave 50 Ω O.D 0.165[4.19] L = 11.80 [299.72] flexible coaxial cable 2 turns through ferrite bead
FB1,FB5	Shield bead
FB2,FB6	Multi-aperture core
FB3	Multilayer ferrite chip bead (surface mount)
FB4	Surface mount EMI shield bead
PCB	Woven glass reinforced ptfе microwave Laminate 0.06", 1 oz EDCu, both sides, $\epsilon_r = 2.55$

Figure 17. 175 MHz test circuit photomaster

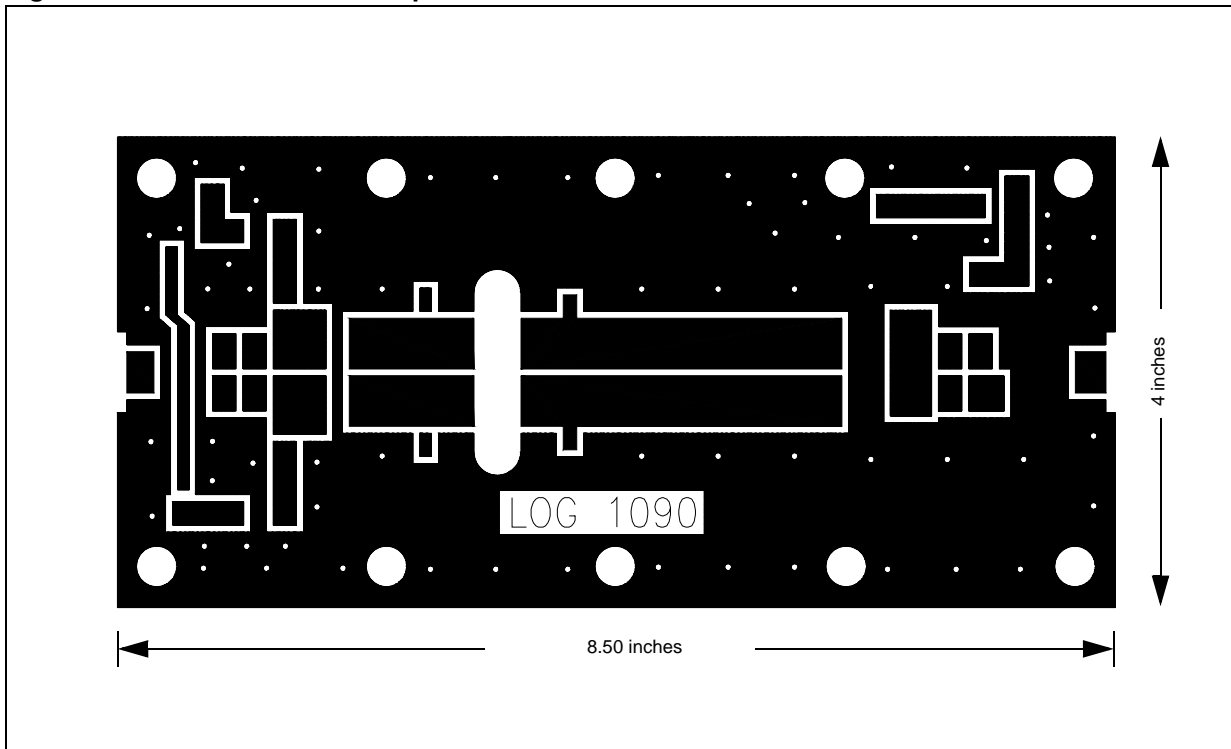
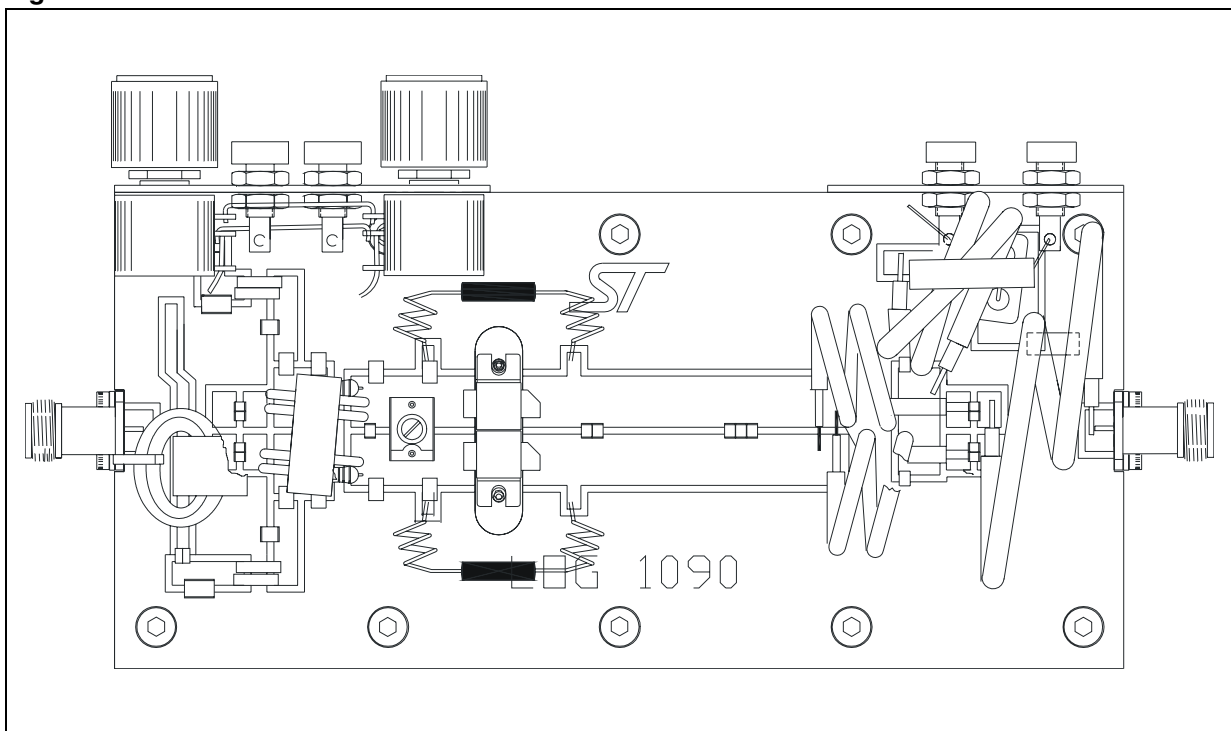

Figure 18. 175 MHz test circuit



6 Package mechanical data

In order to meet environmental requirements, ST offers these devices in different grades of ECOPACK® packages, depending on their level of environmental compliance. ECOPACK® specifications, grade definitions and product status are available at: www.st.com. ECOPACK is an ST trademark.

Table 8. M244 (.400 x .860 4/L BAL N/HERM W/FLG)

DIM.	mm.			inch		
	Min.	Typ.	Max.	Min.	Typ.	Max.
A	5.59		5.84	0.220		0.230
B		5.08			0.200	
C	3.02		3.28	0.119		0.129
D	9.65		9.91	0.380		0.390
E	19.81		20.82	0.780		0.820
F	10.92		11.18	0.430		0.440
G		27.94			1.100	
H	33.91		34.16	1.335		1.345
I	0.10		0.15	0.004		0.006
J	1.52		1.78	0.060		0.070
K	2.59		2.84	0.102		0.112
L	4.83		5.84	0.190		0.230
M	10.03		10.34	0.395		0.407
N	21.59		22.10	0.850		0.870

Figure 19. M244 package dimensions

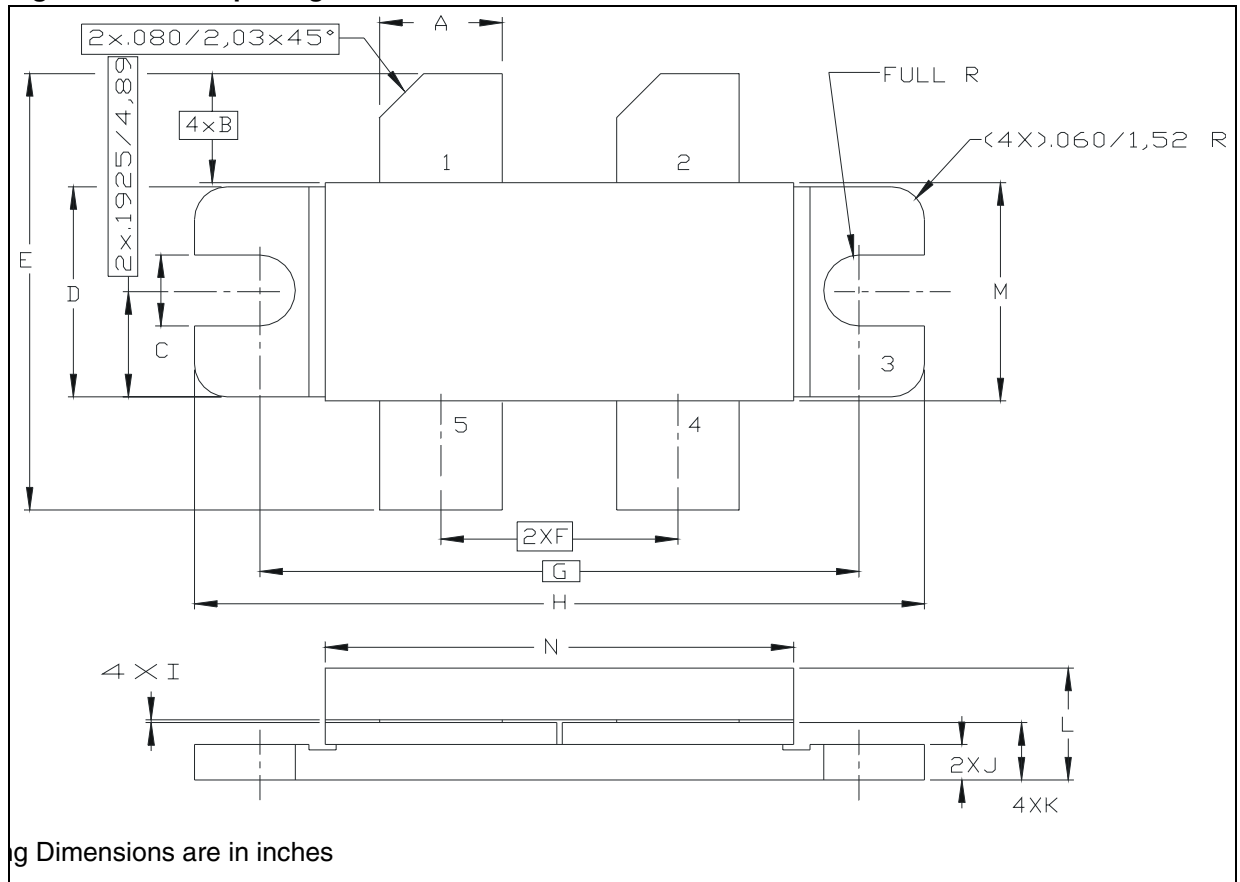

7 Marking, packing and shipping specifications

Table 9. Packing and shipping specifications

Order code	Packaging	Pcs per tray	Dry pack humidity	Lot code
SD2942W	Tube	15	< 10 %	Not mixed

Figure 20. Marking layout

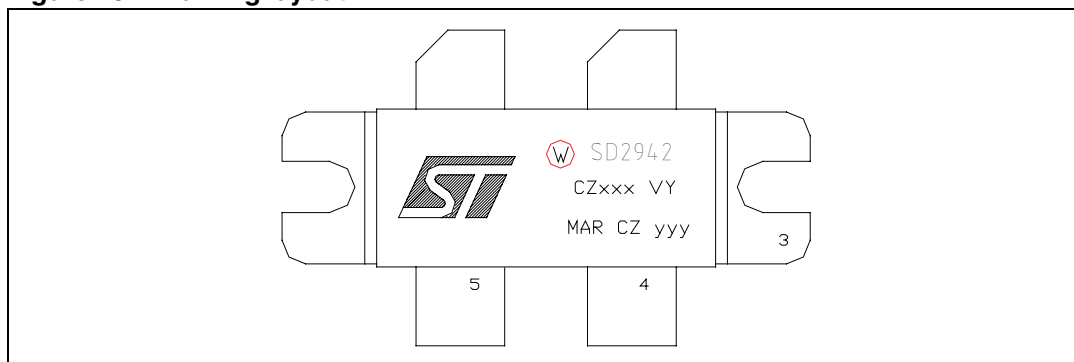

Table 10. Marking specifications

Symbol	Description
W	Wafer process code
CZ	Assembly plant
xxx	Last 3 digits of diffusion lot
VY	Diffusion plant
MAR	Country of origin
CZ	Test and finishing plant
y	Assembly year
yy	Assembly week

8 Revision history

Table 11. Document revision history

Date	Revision	Changes
18-Oct-2005	1	First Issue.
04-Jan-2006	2	Complete version.
14-Apr-2010	3	Added <i>Figure 13</i> , <i>Figure 14</i> and <i>Figure 15</i> .
25-Oct-2011	4	Inserted <i>Chapter 7: Marking, packing and shipping specifications</i> .

Please Read Carefully:

Information in this document is provided solely in connection with ST products. STMicroelectronics NV and its subsidiaries ("ST") reserve the right to make changes, corrections, modifications or improvements, to this document, and the products and services described herein at any time, without notice.

All ST products are sold pursuant to ST's terms and conditions of sale.

Purchasers are solely responsible for the choice, selection and use of the ST products and services described herein, and ST assumes no liability whatsoever relating to the choice, selection or use of the ST products and services described herein.

No license, express or implied, by estoppel or otherwise, to any intellectual property rights is granted under this document. If any part of this document refers to any third party products or services it shall not be deemed a license grant by ST for the use of such third party products or services, or any intellectual property contained therein or considered as a warranty covering the use in any manner whatsoever of such third party products or services or any intellectual property contained therein.

UNLESS OTHERWISE SET FORTH IN ST'S TERMS AND CONDITIONS OF SALE ST DISCLAIMS ANY EXPRESS OR IMPLIED WARRANTY WITH RESPECT TO THE USE AND/OR SALE OF ST PRODUCTS INCLUDING WITHOUT LIMITATION IMPLIED WARRANTIES OF MERCHANTABILITY, FITNESS FOR A PARTICULAR PURPOSE (AND THEIR EQUIVALENTS UNDER THE LAWS OF ANY JURISDICTION), OR INFRINGEMENT OF ANY PATENT, COPYRIGHT OR OTHER INTELLECTUAL PROPERTY RIGHT.

UNLESS EXPRESSLY APPROVED IN WRITING BY TWO AUTHORIZED ST REPRESENTATIVES, ST PRODUCTS ARE NOT RECOMMENDED, AUTHORIZED OR WARRANTED FOR USE IN MILITARY, AIR CRAFT, SPACE, LIFE SAVING, OR LIFE SUSTAINING APPLICATIONS, NOR IN PRODUCTS OR SYSTEMS WHERE FAILURE OR MALFUNCTION MAY RESULT IN PERSONAL INJURY, DEATH, OR SEVERE PROPERTY OR ENVIRONMENTAL DAMAGE. ST PRODUCTS WHICH ARE NOT SPECIFIED AS "AUTOMOTIVE GRADE" MAY ONLY BE USED IN AUTOMOTIVE APPLICATIONS AT USER'S OWN RISK.

Resale of ST products with provisions different from the statements and/or technical features set forth in this document shall immediately void any warranty granted by ST for the ST product or service described herein and shall not create or extend in any manner whatsoever, any liability of ST.

ST and the ST logo are trademarks or registered trademarks of ST in various countries.

Information in this document supersedes and replaces all information previously supplied.

The ST logo is a registered trademark of STMicroelectronics. All other names are the property of their respective owners.

© 2011 STMicroelectronics - All rights reserved

STMicroelectronics group of companies

Australia - Belgium - Brazil - Canada - China - Czech Republic - Finland - France - Germany - Hong Kong - India - Israel - Italy - Japan - Malaysia - Malta - Morocco - Philippines - Singapore - Spain - Sweden - Switzerland - United Kingdom - United States of America

www.st.com

Mouser Electronics

Authorized Distributor

Click to View Pricing, Inventory, Delivery & Lifecycle Information:

[STMicroelectronics:](#)

[SD2942](#) [SD2942W](#)